

Description

The ZXLD1360Q is a continuous mode inductive step-down converter with integrated switch and high side current sense.

It operates from an input supply from 7V to 30V driving single or multiple series connected LEDs efficiently externally adjustable output current up to 1mA.

The output current can be adjusted by applying a DC voltage or a PWM waveform to the ADJ pin; 100:1 adjustment of output current is possible using PWM control. Applying 0.2V or lower to the ADJ pin turns the output off and switches the device into a low current standby state.

The ZXLD1360Q has been qualified to AEC-Q100 Grade 1 and is Automotive Grade supporting PPAPs.

Features

- Simple low parts count
- Single pin on/off and brightness control using DC voltage or PWM
- High efficiency (up to 95%)
- Wide input voltage range: 7V to 30V
- 40V transient capability
- Up to 1MHz switching frequency
- Typical 4% output current accuracy
- Available in thermally enhanced Green molding packages
 - TSOT25 $\theta_{JA} = +82^{\circ}\text{C/W}$
 - **Totally Lead-free & Fully RoHS Compliant (Notes 1 & 2)**
 - **Halogen and Antimony Free. "Green" Device (Note 3)**
- **Automotive Grade**
 - Qualified to AEC-Q100 Grade 1
 - Supports PPAP documents (Note 4)

- Notes:
1. No purposely added lead. Fully EU Directive 2002/95/EC (RoHS) & 2011/65/EU (RoHS 2) compliant.
 2. See http://www.diodes.com/quality/lead_free.html for more information about Diodes Incorporated's definitions of Halogen- and Antimony-free, "Green" and Lead-free.
 3. Halogen- and Antimony-free "Green" products are defined as those which contain <900ppm bromine, <900ppm chlorine (<1500ppm total Br + Cl) and <1000ppm antimony compounds.
 4. Automotive products are AEC-Q100 qualified and are PPAP capable. Automotive, AEC-Q100 and standard products are electrically and thermally the same, except where specified. For more information, please refer to http://www.diodes.com/quality/product_compliance_definitions/.

Pin Assignments

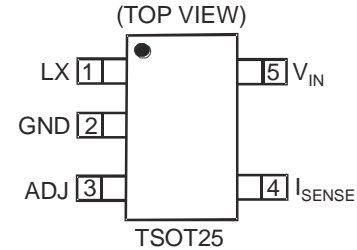

Typical Application Circuit

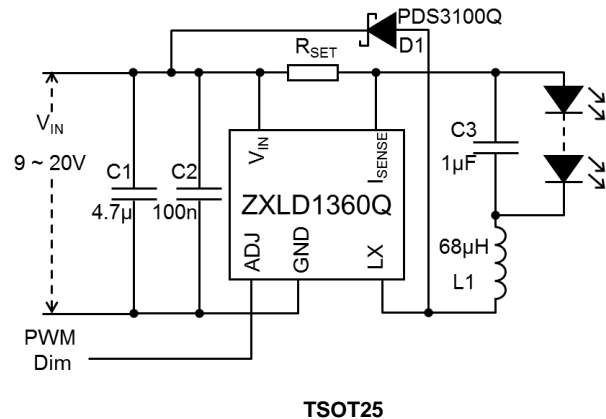

Block Diagram

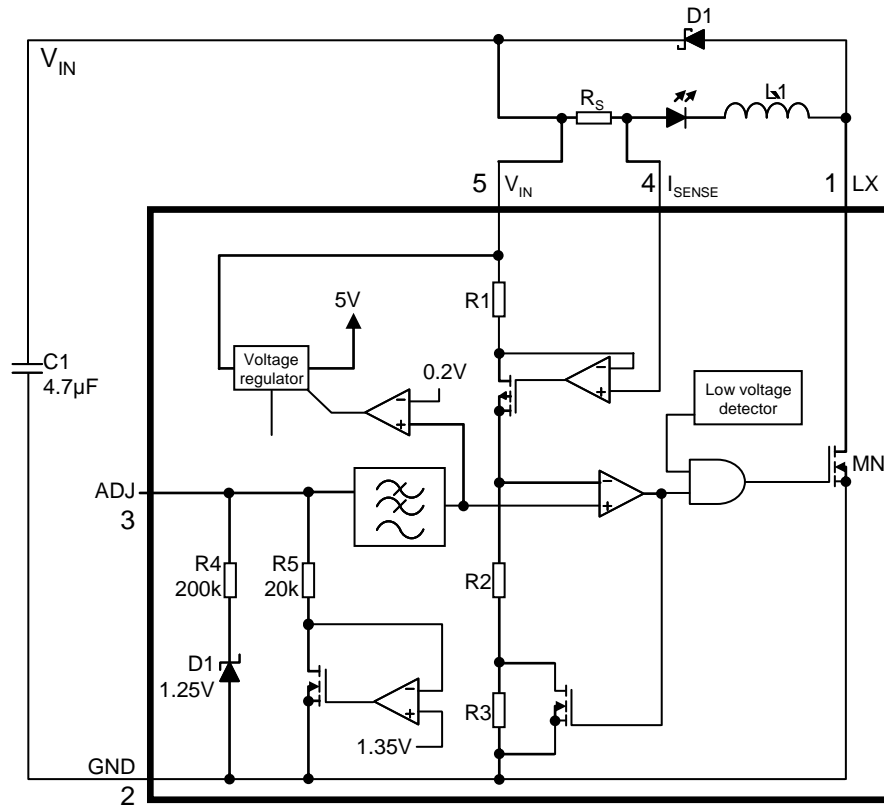

Figure 1 Block diagram – With Pin Connections

Pin Descriptions

Name	Pin No.	Description
LX	1	Drain of NDMOS switch
GND	2	Ground (0V)
ADJ	3	Multi-function On/Off and brightness control pin: <ul style="list-style-type: none"> • Leave floating for normal operation ($V_{ADJ} = V_{REF} = 1.25V$ giving nominal average output current $I_{OUTnom} = 0.1/R_S$) • Drive to voltage below 0.2V to turn off output current • Drive with DC voltage ($0.3V < V_{ADJ} < 2.5V$) to adjust output current from 25% to 200% of I_{OUTnom} • Drive with PWM signal from open-collector or open-drain transistor, to adjust output current • Adjustment range 25% to 100% of I_{OUTnom} for $f > 10kHz$ and 1% to 100% of I_{OUTnom} for $f < 500Hz$ • Connect a capacitor from this pin to ground to increase soft-start time (Default soft-start time = 500µs. Additional soft-start time is approximately 500µs/nF)
I _{SENSE}	4	Connect resistor R_S from this to V_{IN} to define nominal average output current $I_{OUTnom} = 0.1/R_S$ (Note: $R_{SMIN} = 0.1V$ with ADJ pin open circuit)
V _{IN}	5	Input Voltage (7V to 30V) Decouple to ground with 4.7µF of higher X7R ceramic capacitor close to device

Absolute Maximum Ratings (Voltages to GND unless otherwise stated)

Symbol	Parameter	Rating	Unit
V_{IN}	Input Voltage	-0.3 to +30 (40V for 0.5 sec)	V
V_{SENSE}	I_{SENSE} Voltage	+0.3 to -5 (measured with respect to V_{IN})	V
V_{LX}	LX Output Voltage	-0.3 to +30 (40V for 0.5 sec)	V
V_{ADJ}	Adjust Pin Input Voltage	-0.3 to +6	V
I_{LX}	Switch Output Current	1.25	A
P_{TOT}	Power Dissipation (Refer to Package thermal de-rating curve on page 20)	1	W
T_{ST}	Storage Temperature	-55 to 150	°C
$T_{J\ MAX}$	Junction Temperature	150	°C
ESD Susceptibility			
HBM	Human Body Model	500	V
MM	Machine Model	<100	V
CDM	Charged Device Model	1000	V

Caution: Stresses greater than the 'Absolute Maximum Ratings' specified above, may cause permanent damage to the device. These are stress ratings only; functional operation of the device at conditions between maximum recommended operating conditions and absolute maximum ratings is not implied. Device reliability may be affected by exposure to absolute maximum rating conditions for extended periods of time.

Semiconductor devices are ESD sensitive and may be damaged by exposure to ESD events. Suitable ESD precautions should be taken when handling and transporting these devices.

The human body model is a 100pF capacitor discharge through a 1.5kΩ resistor pin. The machine model is a 200pF capacitor discharged directly into each pin.

Thermal Resistance

Symbol	Parameter	Rating	Unit
θ_{JA}	Junction to Ambient	82	°C/W
Ψ_{JB}	Junction to Board	33	°C/W

Recommended Operating Conditions

Symbol	Parameter	Min	Max	Units
V_{IN}	Input Voltage Range	7	30	V
I_{LX}	Maximum Recommended Continuous/RMS Switch Current	—	1	A
V_{ADJ}	External control voltage range on ADJ pin for DC brightness control (Note 5)	0.3	2.5	V
V_{ADJoff}	DC voltage on ADJ pin to ensure devices is off	—	0.25	V
t_{ONmin_REC}	Recommended minimum switch "ON" time	—	800	ns
$f_{LX\ max}$	Recommended maximum operating frequency (Note 6)	—	625	kHz
D_{LX}	Duty cycle range	0.01	0.99	—
T_A	Ambient operating temperature range	-40	+125	°C

Electrical Characteristics (Test conditions: $V_{IN} = 12V$, $T_A = +25^{\circ}C$, unless otherwise specified.)

Symbol	Parameter	Condition	Min.	Typ.	Max.	Unit
V_{SU}	Internal regulator start-up threshold	V_{IN} rising	—	5.65	—	V
V_{SD}	Internal regulator shutdown threshold	V_{IN} falling	—	5.55	—	V
I_{INQoff}	Quiescent supply current with output off	ADJ pin grounded	—	20	40	μA
I_{INQon}	Quiescent supply current with output switching (Note 7)	ADJ pin floating $f=250kHz$	—	1.8	5.0	mA
V_{SENSE}	Mean current sense threshold voltage (Defines LED current setting accuracy)	Measured on I_{SENSE} pin with respect to V_{IN} $V_{ADJ} = 1.25V$	95	100	105	mV
$V_{SENSEHYS}$	Sense threshold hysteresis	—	—	± 15	—	%
I_{SENSE}	I_{SENSE} pin input current	$V_{SENSE} = V_{IN} - 0.1$	—	1.25	10	μA
V_{REF}	Internal reference voltage	Measured on ADJ pin with pin floating	—	1.25	—	V
$\Delta V_{REF}/\Delta T$	Temperature coefficient of V_{REF}	—	—	50	—	ppm/ $^{\circ}C$
V_{ADJ}	External control voltage range on ADJ pin for DC brightness control (Note 5)	—	0.3	—	2.5	V
V_{ADJoff}	DC voltage on ADJ pin to switch device from active (on) state to quiescent (off) state	V_{ADJ} falling	0.15	0.2	0.25	V
V_{ADJon}	DC voltage on ADJ pin to switch device from quiescent (off) state to active (on) state	V_{ADJ} rising	0.2	0.25	0.3	V
R_{ADJ}	Resistance between ADJ pin and V_{REF}	$0 < V_{ADJ} < V_{REF}$	135	—	250	k Ω
		$V_{ADJ} > V_{REF} + 100mV$	13.5	—	25	
I_{LXmean}	Continuous LX switch current	—	—	—	1	A
R_{LX}	LX switch 'On' resistance	@ $I_{LX}=0.55A$	—	0.5	1.0	Ω
$I_{LX(leak)}$	LX switch leakage current	—	—	—	5	μA
$D_{PWM(LF)}$	Duty cycle range of PWM signal applied to ADJ pin during low frequency PWM dimming mode Brightness control range	PWM frequency <500Hz PWM amplitude = V_{REF} Measured on ADJ pin	0.01	—	1	—
		—	—	100:1	—	—
$D_{PWM(HF)}$	Duty cycle range of PWM signal applied to ADJ pin during high frequency PWM dimming mode Brightness control range	PWM frequency >10kHz PWM amplitude = V_{REF} Measured on ADJ pin	0.16	—	1	—
		—	—	5:1	—	—
DC_{ADJ}	DC brightness control range	(Note 8)	—	5:1	—	—
t_{SS}	Soft start time	Time taken for output current to reach 90% of final value after voltage on ADJ pin has risen above 0.3V	—	500	—	μs
f_{LX}	Operating frequency (See graphs for more details)	ADJ pin floating $L = 33\mu H$ (0.093V) $I_{OUT} = 1A$ @ $V_{LED} = 3.6V$ Driving 1 LED	—	280	—	kHz
t_{OFFMIN}	Minimum switch off-time	—	—	200	—	ns
t_{ONMIN}	Minimum switch on-time	—	—	240	—	ns
t_{PD}	Internal comparator propagation delay	—	—	50	—	ns

Notes: 5. 100% brightness corresponds to $V_{ADJ} = V_{ADJ(nom)} = V_{REF}$ (~1.25V). Driving the ADJ pin above V_{REF} will increase the V_{SENSE} threshold and output current proportionally.

6. ZXLD1360Q will operate at higher frequencies, but due to propagation delays accuracy will be affected.

7. Static current of device is approximately 450 μA , see Supply Current Graph, Page 10.

8. Ratio of maximum brightness to minimum brightness before shutdown $V_{REF} = 1.25/0.3$. V_{REF} externally driven to 2.5V, ratio 10:1.

Device Description

The device, in conjunction with the coil (L1) and current sense resistor (RS), forms a self-oscillating continuous-mode buck converter.

Device Operation (Refer to Figure 1 - Block diagram and Figure 2 Operating Waveforms)

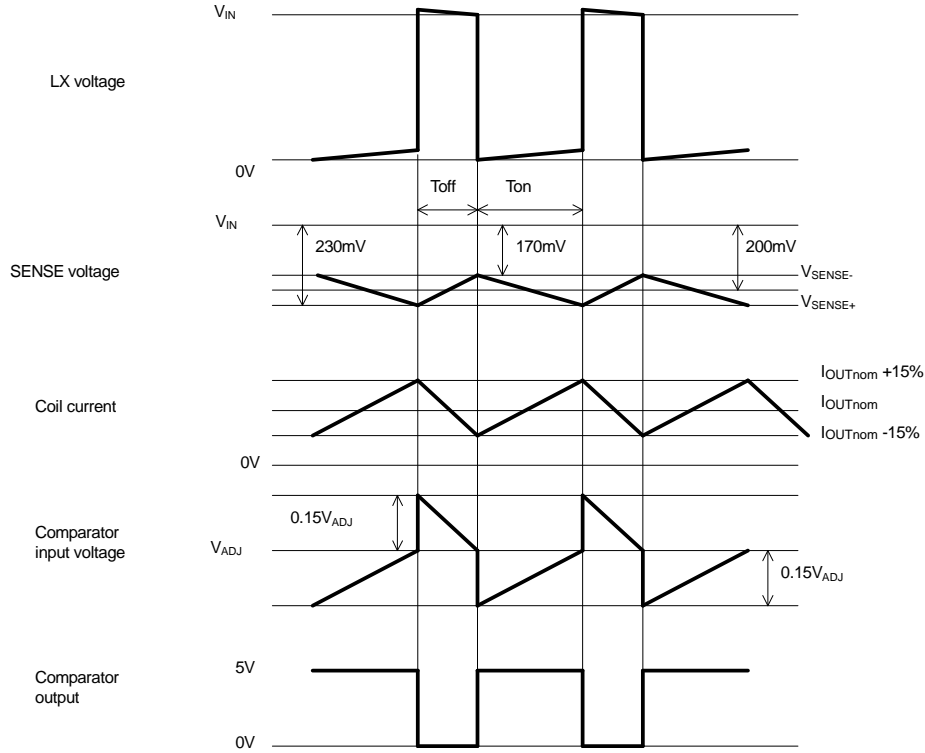

Figure 2 Operating Waveforms

Operation can be best understood by assuming that the ADJ pin of the device is unconnected and the voltage on this pin (V_{ADJ}) appears directly at the (+) input of the comparator.

When input voltage V_{IN} is first applied, the initial current in L1 and R_S is zero and there is no output from the current sense circuit. Under this condition, the (-) input to the comparator is at ground and its output is high. This turns MN on and switches the LX pin low, causing current to flow from V_{IN} to ground, via R_S , L1 and the LED(s). The current rises at a rate determined by V_{IN} and L1 to produce a voltage ramp (V_{SENSE}) across R_S . The supply referred voltage V_{SENSE} is forced across internal resistor R1 by the current sense circuit and produces a proportional current in internal resistors R2 and R3. This produces a ground referred rising voltage at the (-) input of the comparator. When this reaches the threshold voltage (V_{ADJ}), the comparator output switches low and MN turns off. The comparator output also drives another NMOS switch, which bypasses internal resistor R3 to provide a controlled amount of hysteresis. The hysteresis is set by R3 to be nominally 15% of V_{ADJ} .

When MN is off, the current in L1 continues to flow via D1 and the LED(s) back to V_{IN} . The current decays at a rate determined by the LED(s) and diode forward voltages to produce a falling voltage at the input of the comparator. When this voltage returns to V_{ADJ} , the comparator output switches high again. This cycle of events repeats, with the comparator input ramping between limits of $V_{ADJ} \pm 15\%$.

Switching thresholds

With $V_{ADJ} = V_{REF}$, the ratios of R1, R2 and R3 define an average V_{SENSE} switching threshold of 100mV (measured on the I_{SENSE} pin with respect to V_{IN}). The average output current I_{OUTnom} is then defined by this voltage and R_S according to:

$$I_{OUTnom} = 100mV/R_S$$

Nominal ripple current is $\pm 15mV/R_S$

Device Description (cont.)

Actual operating waveforms: Normal operation

$V_{IN}=15V, R_S=0.1V, L=33\mu H.$

Output current (Ch1) and LX voltage (Ch2)

Tek Run: 25.0MS/s Hi Res

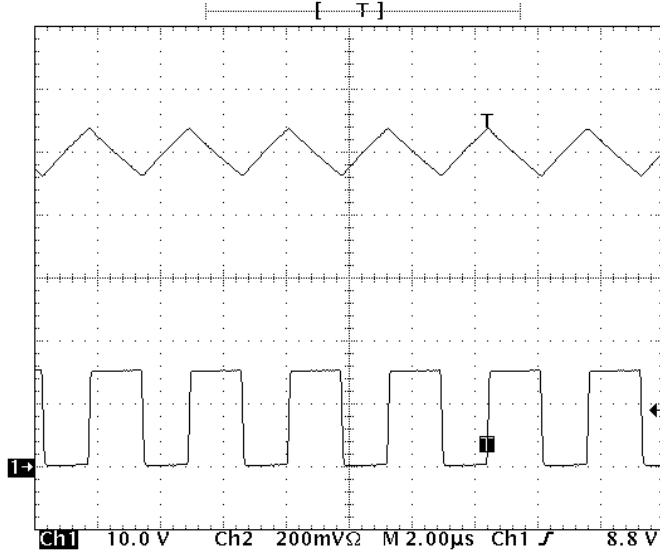

$V_{IN}=30V, R_S=0.1V, L=33\mu H$

Output current (Ch1) and LX voltage (Ch2)

Tek Run: 25.0MS/s Hi Res

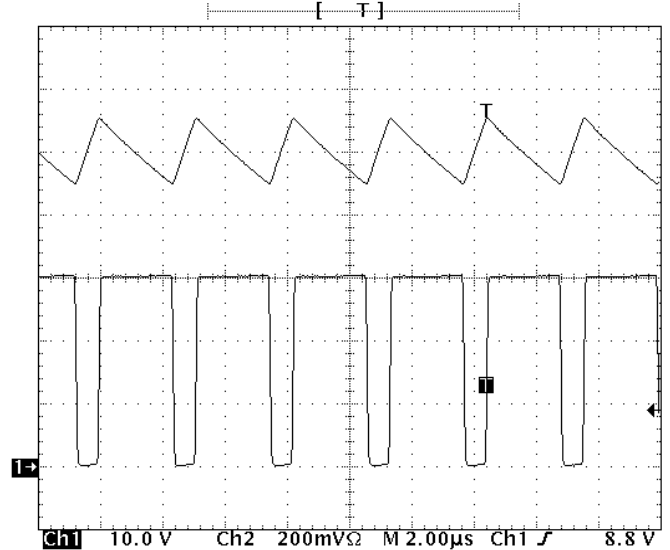

Adjusting Output Current

The device contains a low pass filter between the ADJ pin and the threshold comparator and an internal current limiting resistor (200kV nom) between ADJ and the internal reference voltage. This allows the ADJ pin to be overdriven with either DC or pulse signals to change the V_{SENSE} switching threshold and adjust the output current. The filter is third order, comprising three sections, each with a cut-off frequency of nominally 4kHz.

Details of the different modes of adjusting output current are given in the applications section.

Output Shutdown

The output of the low pass filter drives the shutdown circuit. When the input voltage to this circuit falls below the threshold (0.2V nom.), the internal regulator and the output switch are turned off. The voltage reference remains powered during shutdown to provide the bias current for the shutdown circuit. Quiescent supply current during shutdown is nominally 20mA and switch leakage is below 5mA.

Typical Operating Characteristics

ZXLD1360 Output Current
L = 33 μ H

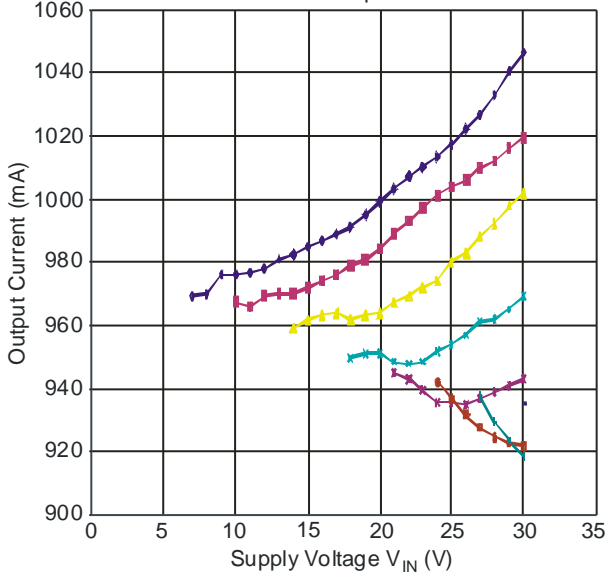

◆ 1 LED ◆ 2 LEDs ◆ 3 LEDs ◆ 4 LEDs ◆ 5 LEDs ◆ 6 LEDs ◆ 7 LEDs ◆ 8 LEDs

ZXLD1360 Output Current
L = 33 μ H

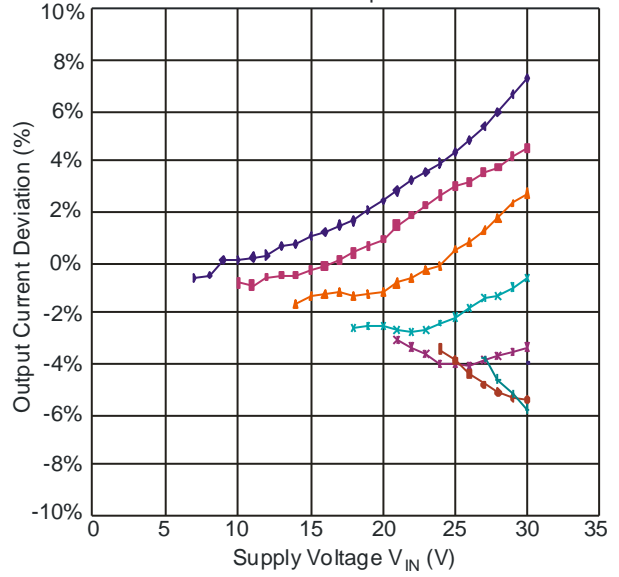

◆ 1 LED ◆ 2 LEDs ◆ 3 LEDs ◆ 4 LEDs ◆ 5 LEDs ◆ 6 LEDs ◆ 7 LEDs ◆ 8 LEDs

ZXLD1360 Switching Frequency
L = 33 μ H

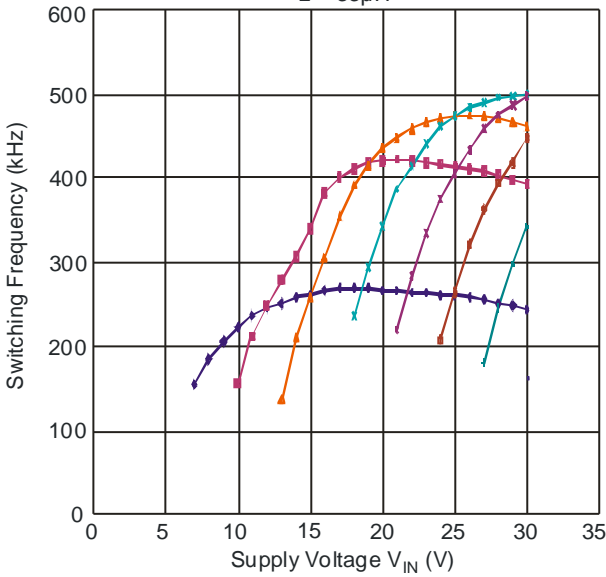

◆ 1 LED ◆ 2 LEDs ◆ 3 LEDs ◆ 4 LEDs ◆ 5 LEDs ◆ 6 LEDs ◆ 7 LEDs ◆ 8 LEDs

ZXLD1360 Duty Cycle
L = 33 μ H

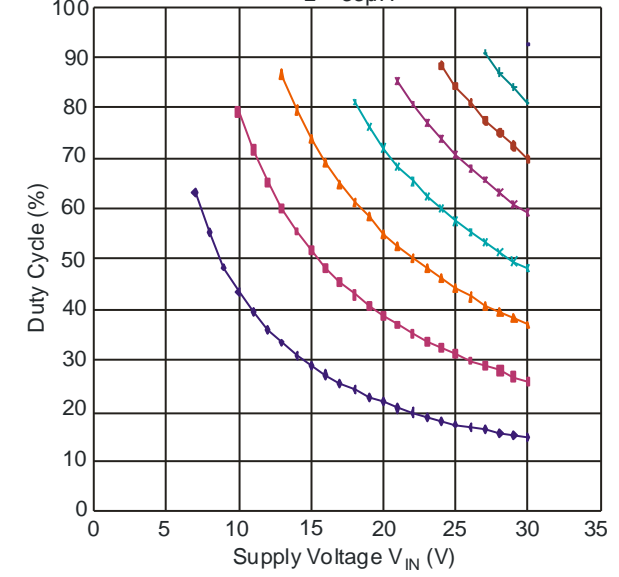

◆ 1 LED ◆ 2 LEDs ◆ 3 LEDs ◆ 4 LEDs ◆ 5 LEDs ◆ 6 LEDs ◆ 7 LEDs ◆ 8 LEDs

Typical Operating Characteristics (cont.)

ZXLD1360 Output Current
L = 47 μ H

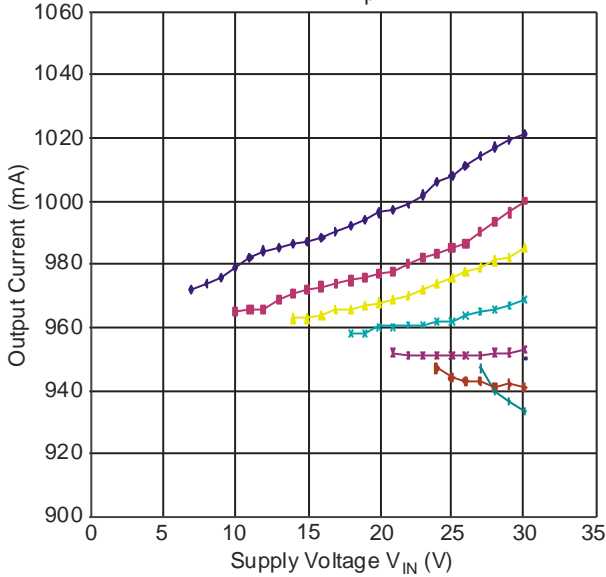

1 LED 2 LEDs 3 LEDs 4 LEDs 5 LEDs 6 LEDs 7 LEDs 8 LEDs

ZXLD1360 Output Current
L = 47 μ H

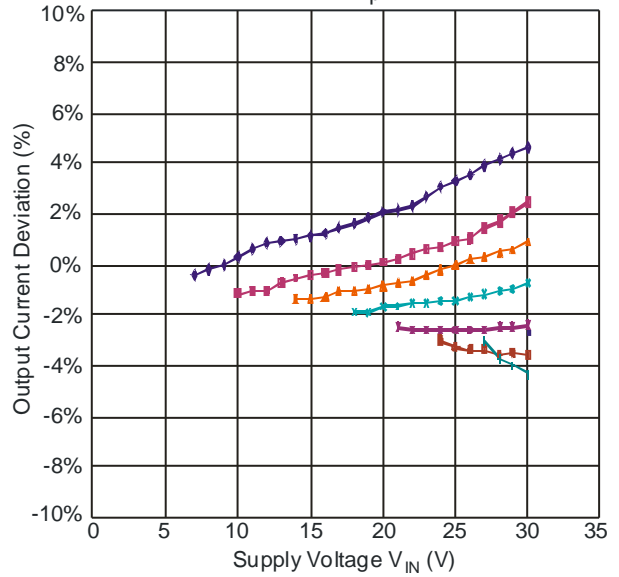

1 LED 2 LEDs 3 LEDs 4 LEDs 5 LEDs 6 LEDs 7 LEDs 8 LEDs

ZXLD1360 Switching Frequency
L = 47 μ H

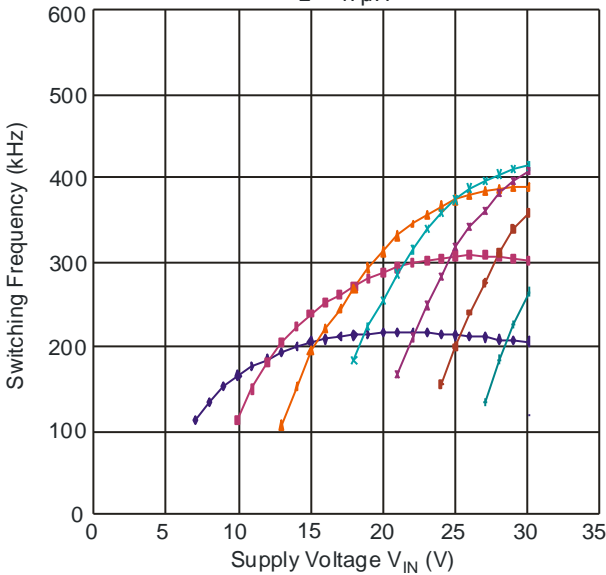

1 LED 2 LEDs 3 LEDs 4 LEDs 5 LEDs 6 LEDs 7 LEDs 8 LEDs

ZXLD1360 Duty Cycle
L = 47 μ H

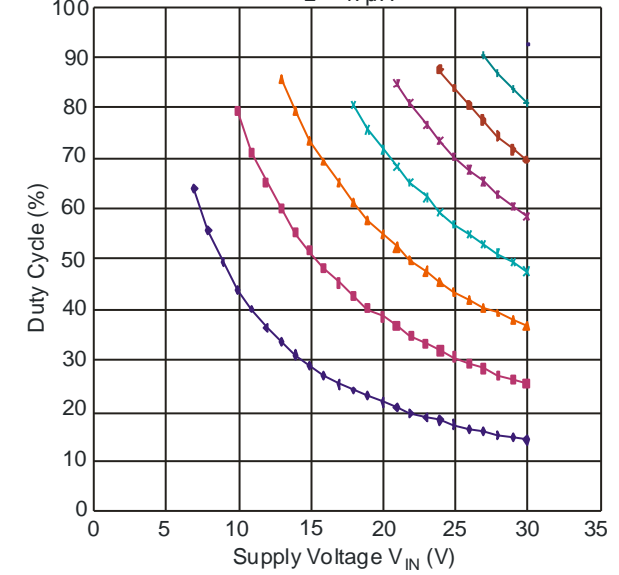

1 LED 2 LEDs 3 LEDs 4 LEDs 5 LEDs 6 LEDs 7 LEDs 8 LEDs

Typical Operating Characteristics (cont.)

ZXLD1360 Output Current
L = 100μH

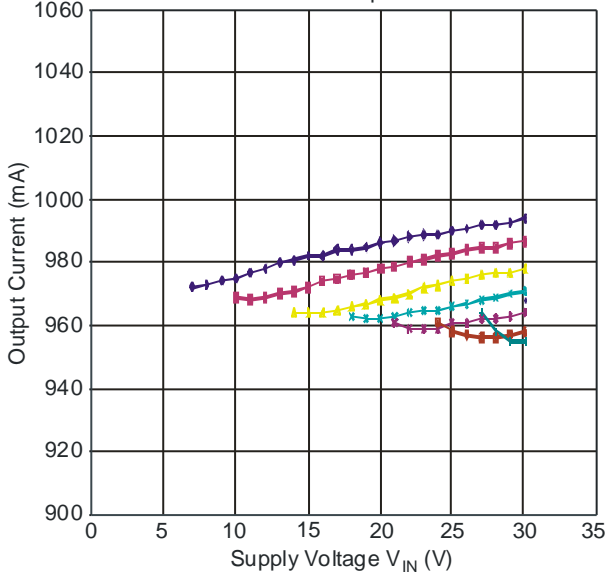

1 LED 2 LEDs 3 LEDs 4 LEDs 5 LEDs 6 LEDs 7 LEDs 8 LEDs

ZXLD1360 Output Current
L = 100μH

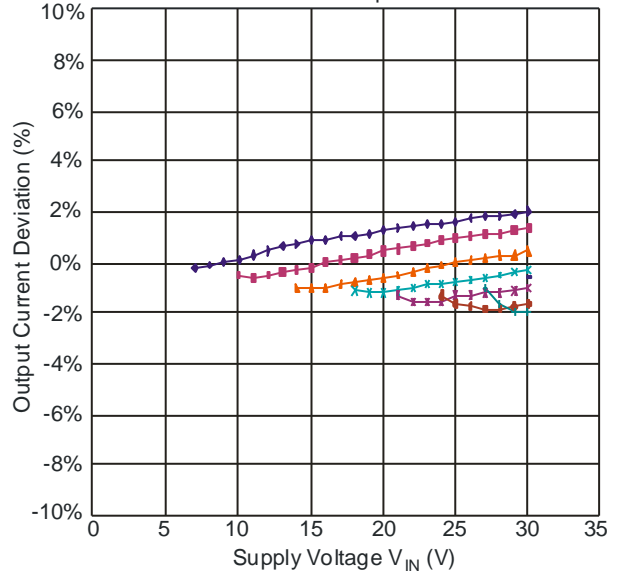

1 LED 2 LEDs 3 LEDs 4 LEDs 5 LEDs 6 LEDs 7 LEDs 8 LEDs

ZXLD1360 Switching Frequency
L = 100μH

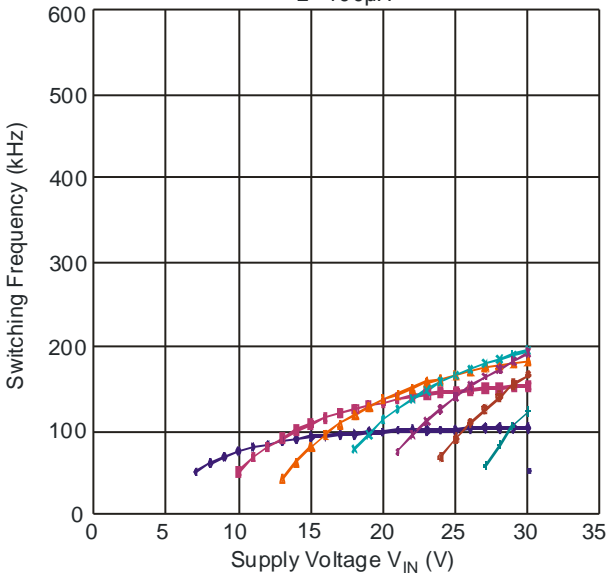

1 LED 2 LEDs 3 LEDs 4 LEDs 5 LEDs 6 LEDs 7 LEDs 8 LEDs

ZXLD1360 Duty Cycle
L = 100μH

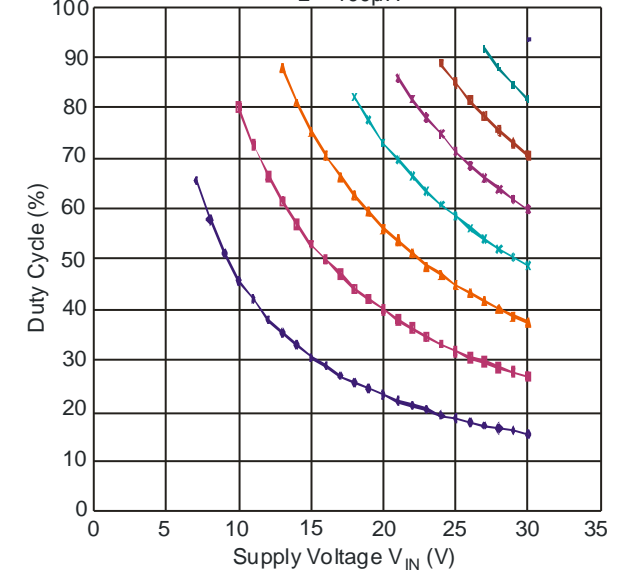

1 LED 2 LEDs 3 LEDs 4 LEDs 5 LEDs 6 LEDs 7 LEDs 8 LEDs

Typical Operating Characteristics (cont.)

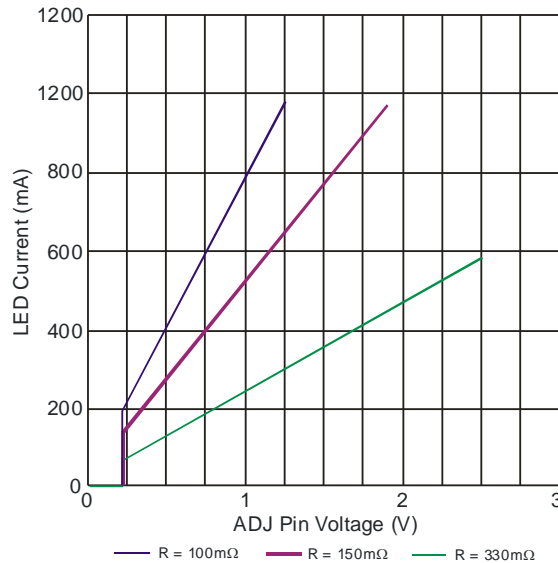
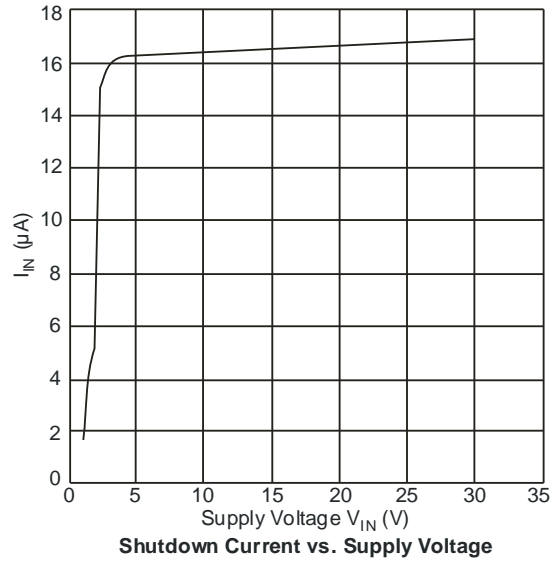
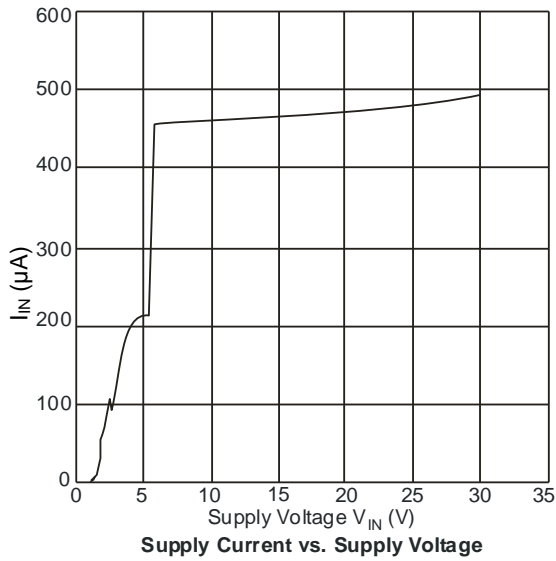
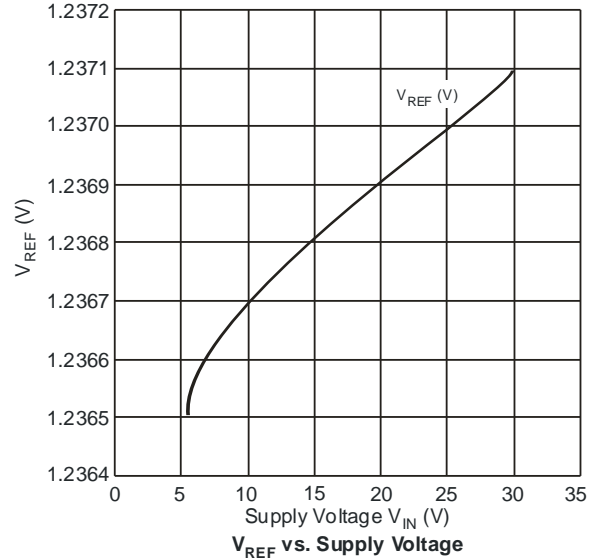
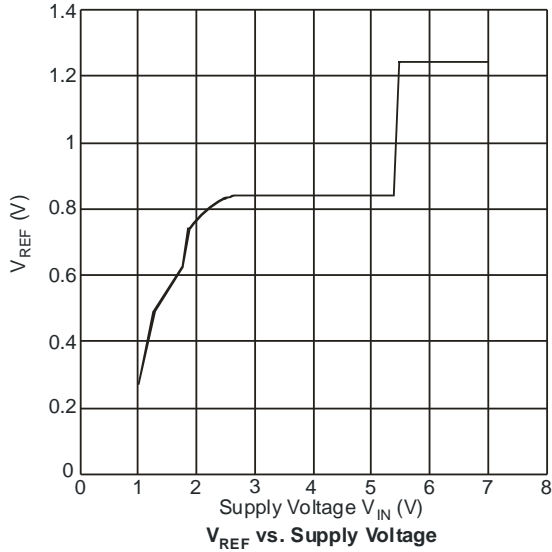

Typical Operating Characteristics (cont.)

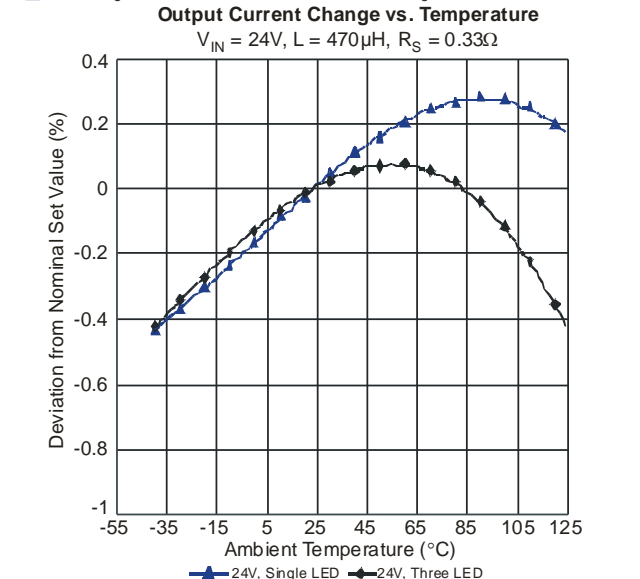
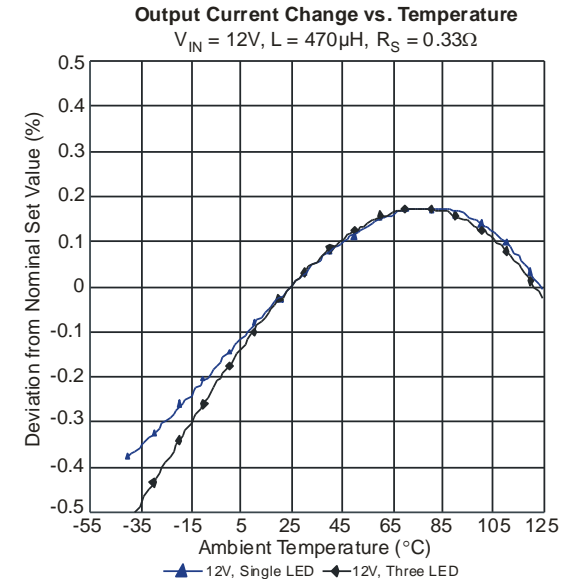
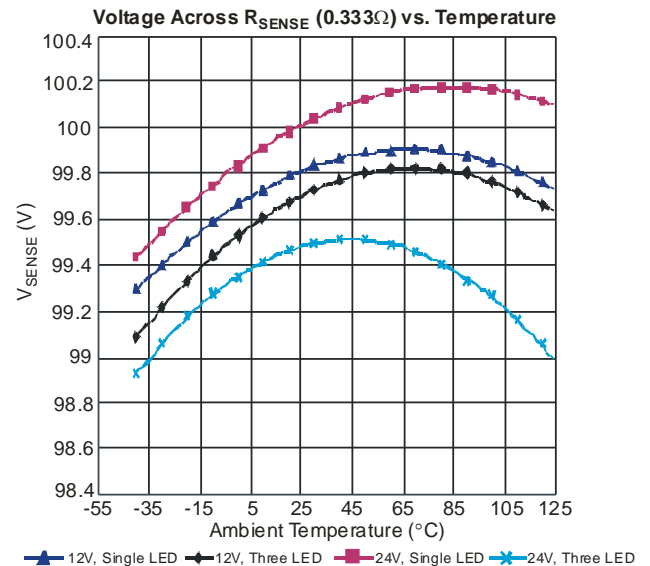
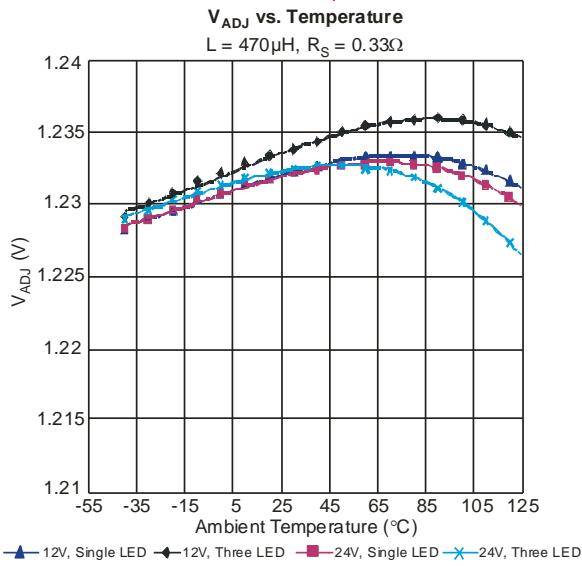
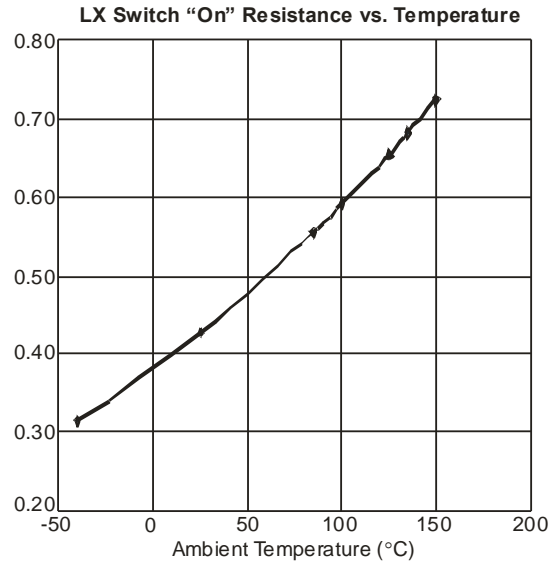
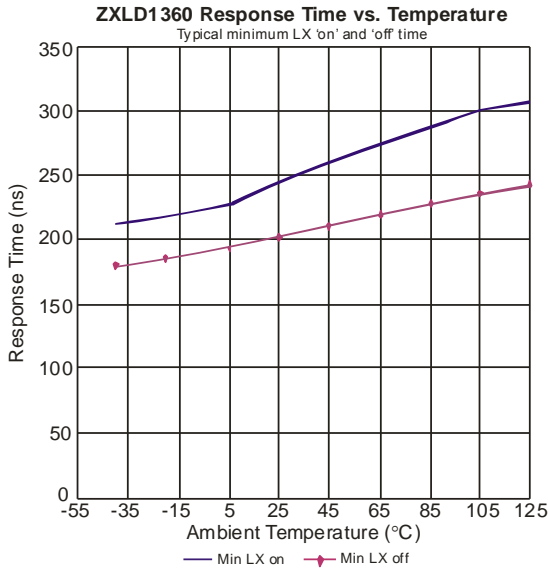

Application Information

Setting Nominal Average Output Current with External Resistor R_S

The nominal average output current in the LED(s) is determined by the value of the external current sense resistor (R_S) connected between V_{IN} and I_{SENSE} and is given by:

$$I_{OUTnom} = 0.1/R_S \text{ [for } R_S > 0.1\Omega\text{]}$$

The table below gives values of nominal average output current for several preferred values of current setting resistor (R_S) in the typical application circuit shown on page 1:

R_S (Ω)	Nominal Average Output Current (mA)
0.1	1000
0.13	760
0.15	667

The above values assume that the ADJ pin is floating and at a nominal voltage of V_{REF} ($\approx 1.25V$). Note that $R_S = 0.1V$ is the minimum allowed value of sense resistor under these conditions to maintain switch current below the specified maximum value.

It is possible to use different values of R_S if the ADJ pin is driven from an external voltage. (See next section).

Output current adjustment by external DC control voltage

The ADJ pin can be driven by an external DC voltage (V_{ADJ}), as shown, to adjust the output current to a value above or below the nominal average value defined by R_S .

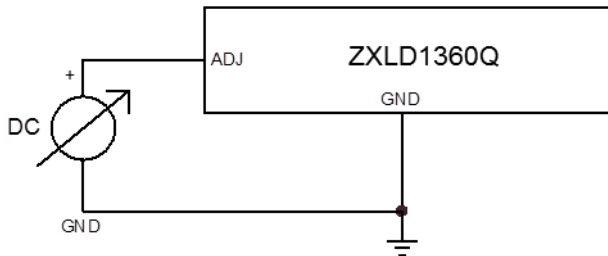

The nominal average output current in this case is given by:

$$I_{OUTdc} = (V_{ADJ} / 1.25) \times (100mV/R_S) \text{ [for } 0.3 < V_{ADJ} < 2.5V\text{]}$$

Note that 100% brightness setting corresponds to $V_{ADJ} = V_{REF}$. When driving the ADJ pin above 1.25V, R_S must be increased in proportion to prevent I_{OUTdc} exceeding 550mA maximum.

The input impedance of the ADJ pin is $50k\Omega \pm 25\%$ for voltages below V_{REF} and $20k\Omega \pm 25\%$ for voltages above $V_{REF} + 100mV$.

Application Information (cont.)

Directly driving ADJ input

A Pulse Width Modulated (PWM) signal with duty cycle D_{PWM} can be applied to the ADJ pin, as shown below, to adjust the output current to a value above or below the nominal average value set by resistor R_S :

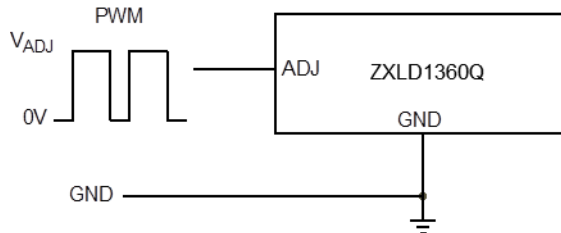

Driving the ADJ input via open collector transistor

The recommended method of driving the ADJ pin and controlling the amplitude of the PWM waveform is to use a small NPN switching transistor as shown below:

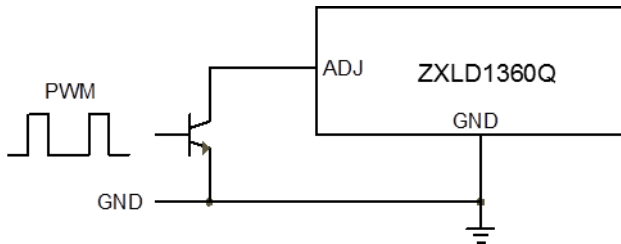

This scheme uses the 200k resistor between the ADJ pin and the internal voltage reference as a pull-up resistor for the external transistor.

Driving the ADJ input from a microcontroller

Another possibility is to drive the device from the open drain output of a microcontroller. The diagram below shows one method of doing this:

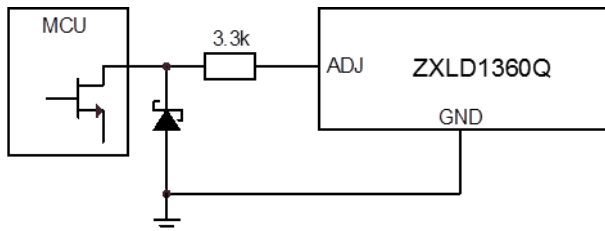

If the NMOS transistor within the microcontroller has high Drain / Source capacitance, this arrangement can inject a negative spike into ADJ input of the 1360 and cause erratic operation but the addition of a Schottky clamp diode (cathode to ADJ) to ground and inclusion of a series resistor (10k) will prevent this. See the section on PWM dimming for more details of the various modes of control using high frequency and low frequency PWM signals.

Application Information (cont.)

Shutdown Mode

Taking the ADJ pin to a voltage below 0.2V for more than approximately 100µs will turn off the output and supply current to a low standby level of 20µA nominal.

Note that the ADJ pin is not a logic input. Taking the ADJ pin to a voltage above V_{REF} will increase output current above the 100% nominal average value. (See graphs for details).

Soft-start

The device has inbuilt soft-start action due to the delay through the PWM filter. An external capacitor from the ADJ pin to ground will provide additional soft-start delay, by increasing the time taken for the voltage on this pin to rise to the turn-on threshold and by slowing down the rate of rise of the control voltage at the input of the comparator. With no external capacitor, the time taken for the output to reach 90% of its final value is approximately 500µs. Adding capacitance increases this delay by approximately 0.5ms/nF. The graph below shows the variation of soft-start time for different values of capacitor.

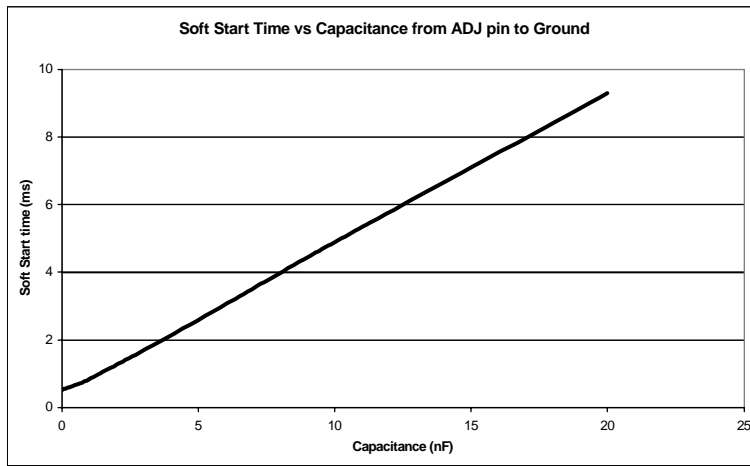

Actual operating waveforms: Soft-start operation

$V_{IN}=15V$, $R_S=0.1V$, $L=33\mu H$, 0nF on ADJ
Output current (Ch2) and LX voltage (Ch1)

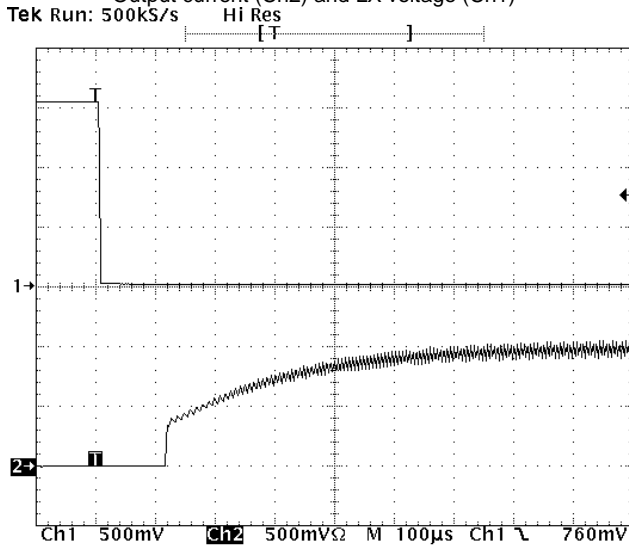

$V_{IN}=15V$, $R_S=0.1V$, $L=33\mu H$, 100nF on ADJ
Output current (Ch2) and LX voltage (Ch1)

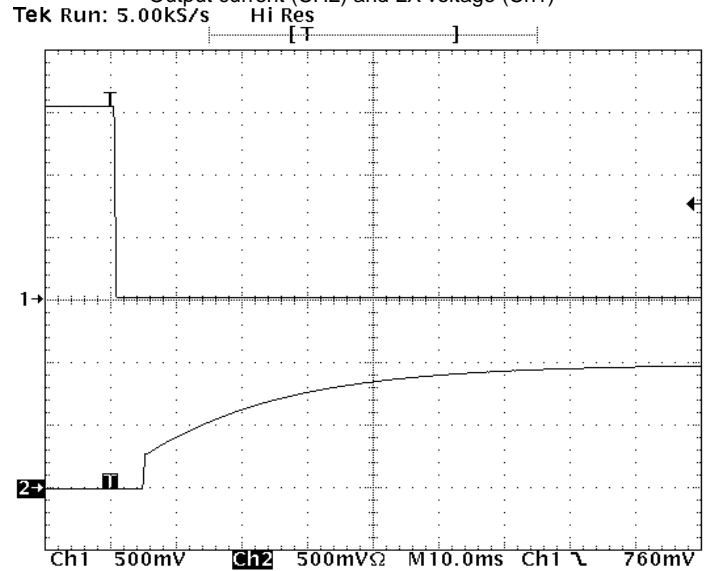

The trace above left shows the typical soft startup time (t_{SS}) of 500µs with no additional capacitance added to the ADJ pin. The trace above right has had its soft-start time extended on the trace by adding a 100nF ceramic capacitor which gives a soft-start time (t_{SS}) of 40 ms approximately.

Application Information (cont.)

Inherent open-circuit LED protection

If the connection to the LED(s) is open-circuited, the coil is isolated from the LX pin of the chip, so the device will not be damaged, unlike in many boost converters, where the back EMF may damage the internal switch by forcing the drain above its breakdown voltage.

Capacitor selection

A low ESR capacitor should be used for input decoupling, as the ESR of this capacitor appears in series with the supply source impedance and lowers overall efficiency. This capacitor has to supply the relatively high peak current to the coil and smooth the current ripple on the input supply. A minimum value of 4.7µF is acceptable if the input source is close to the device, but higher values will improve performance at lower input voltages, especially when the source impedance is high. The input capacitor should be placed as close as possible to the IC.

For maximum stability over temperature and voltage, capacitors with X7R, X5R, or better dielectric are recommended. Capacitors with Y5V dielectric are not suitable for decoupling in this application and should **NOT** be used.

A suitable Murata capacitor would be GRM42-2X7R475K-50.

The following web sites are useful when finding alternatives:

www.murata.com
 www.t-yuden.com
 www.kemet.com
 www.avxcorp.com

Inductor Selection

Recommended inductor values for the ZXLD1360Q are in the range 33µH to 100µH.

Higher values of inductance are recommended at higher supply voltages in order to minimize errors due to switching delays, which result in increased ripple and lower efficiency. Higher values of inductance also result in a smaller change in output current over the supply voltage range (see graphs). The inductor should be mounted as close to the device as possible with low resistance connections to the LX and VIN pins.

The chosen coil should have a saturation current higher than the peak output current and a continuous current rating above the required mean output current.

Suitable coils for use with the ZXLD1360Q are listed in the table below:

Part No.	L (µH)	DCR (V)	ISAT (A)	Manufacturer
MSS1038-333	33	0.093	2.3	Coilcraft www.coilcraft.com
MSS1038-683	68	0.213	1.5	
NPIS64D330MTRF	33	0.124	1.1	NIC www.niccomp.com

The inductor value should be chosen to maintain operating duty cycle and switch 'on'/'off' times within the specified limits over the supply voltage and load current range.

The following equations can be used as a guide, with reference to Figure 2 - Operating Waveforms.

LX Switch 'On' time

$$t_{ON} = \frac{L\Delta I}{V_{IN} - V_{LED} - I_{avg} \times (R_S + r_L + R_{LX})}$$

Note: $t_{ONmin} > 240ns$

Where:

L is the coil inductance (H)
 R_S is the current sense resistance (Ω)
 ΔI is the coil peak-peak ripple current (A) {Internally set to 0.3 x Iavg}
 V_{IN} is the supply voltage (V)
 R_{LX} is the switch resistance (Ω) {=0.5Ω nominal}

LX Switch 'Off' time

$$t_{OFF} = \frac{L\Delta I}{V_{LED} + V_D + I_{avg} \times (R_S + r_L)}$$

Note: $t_{OFFmin} > 200ns$

r_L is the coil resistance (Ω)
 I_{avg} is the required LED current (A)
 V_{LED} is the total LED forward voltage (V)
 V_D is the diode forward voltage at the required load current (V)

Application Information (cont.)

Example:

For $V_{IN} = 12V$, $L = 33\mu H$, $r_L = 0.093$, $R_S = 0.1\Omega$, $R_{LX} = 0.15\Omega$, $V_{LED} = 3.6V$, $I_{avg} = 1A$ and $V_D = 0.49V$

$$t_{ON} = (33e-6 \times 0.3) / (12 - 3.6 - 0.693) = 1.28\mu s$$

$$t_{OFF} = (33e-6 \times 0.3) / (3.6 + 0.49 + 0.193) = 2.31\mu s$$

This gives an operating frequency of 280kHz and a duty cycle of 0.35.

These and other equations are available as a spreadsheet calculator from the Diodes website at www.diodes.com.

Note that in practice, the duty cycle and operating frequency will deviate from the calculated values due to dynamic switching delays, switch rise/fall times and losses in the external components.

Optimum performance will be achieved by setting the duty cycle close to 0.5 at the nominal supply voltage. This helps to equalize the undershoot and overshoot and improves temperature stability of the output current.

Diode selection

For maximum efficiency and performance, the rectifier (D1) should be a fast low capacitance Schottky diode with low reverse leakage at the maximum operating voltage and temperature. A suitable device is the PDS3100Q.

They also provide better efficiency than silicon diodes, due to a combination of lower forward voltage and reduced recovery time.

It is important to select parts with a peak current rating above the peak coil current and a continuous current rating higher than the maximum output load current. It is very important to consider the reverse leakage of the diode when operating above +85°C. Excess leakage will increase the power dissipation in the device and if close to the load may create a thermal runaway condition.

The higher forward voltage and overshoot due to reverse recovery time in silicon diodes will increase the peak voltage on the LX output. If a silicon diode is used, care should be taken to ensure that the total voltage appearing on the LX pin including supply ripple, does not exceed the specified maximum value.

Reducing Output Ripple

Peak to peak ripple current in the LED(s) can be reduced, if required, by shunting a capacitor C_{LED} across the LED(s) as shown below:

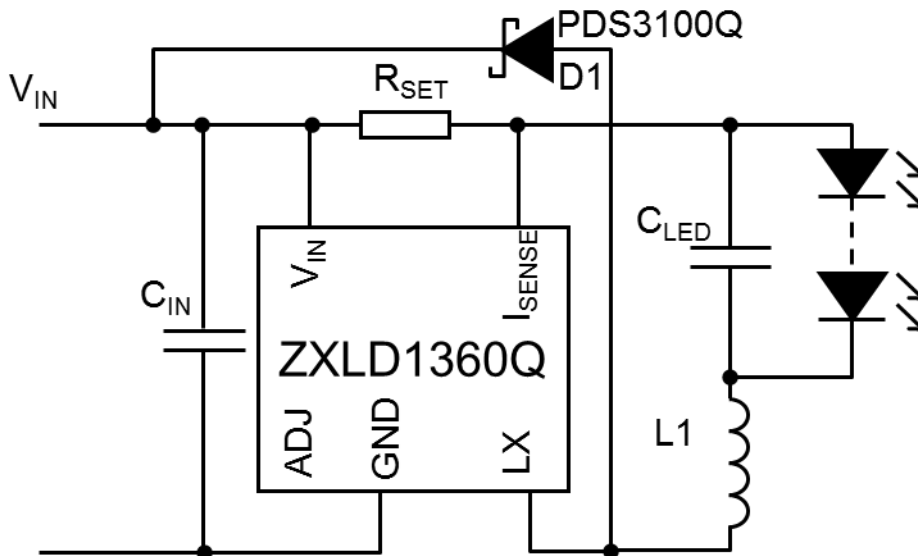

Application Information (cont.)

A value of 1 μ F will reduce the supply ripple current by a factor three (approx.). Proportionally lower ripple can be achieved with higher capacitor values. Note that the capacitor will not affect operating frequency or efficiency, but it will increase start-up delay, by reducing the rate of rise of LED voltage.

By adding this capacitor the current waveform through the LED(s) changes from a triangular ramp to a more sinusoidal version without altering the mean current value.

Operation at low supply voltage

The internal regulator disables the drive to the switch until the supply has risen above the start-up threshold (V_{SU}). Above this threshold, the device will start to operate. However, with the supply voltage below the specified minimum value, the switch duty cycle will be high and the device power dissipation will be at a maximum. Care should be taken to avoid operating the device under such conditions in the application, in order to minimize the risk of exceeding the maximum allowed die temperature. (See next section on thermal considerations). The drive to the switch is turned off when the supply voltage falls below the under-voltage threshold (V_{SD}). This prevents the switch working with excessive 'on' resistance under conditions where the duty cycle is high.

Note that when driving loads of two or more LEDs, the forward drop will normally be sufficient to prevent the device from switching below approximately 6V. This will minimize the risk of damage to the device.

Thermal considerations

When operating the device at high ambient temperatures, or when driving maximum load current, care must be taken to avoid exceeding the package power dissipation limits. The graph below gives details for power derating. This assumes the device to be mounted on a 25mm x 25mm PCB with 1oz copper standing in still air.

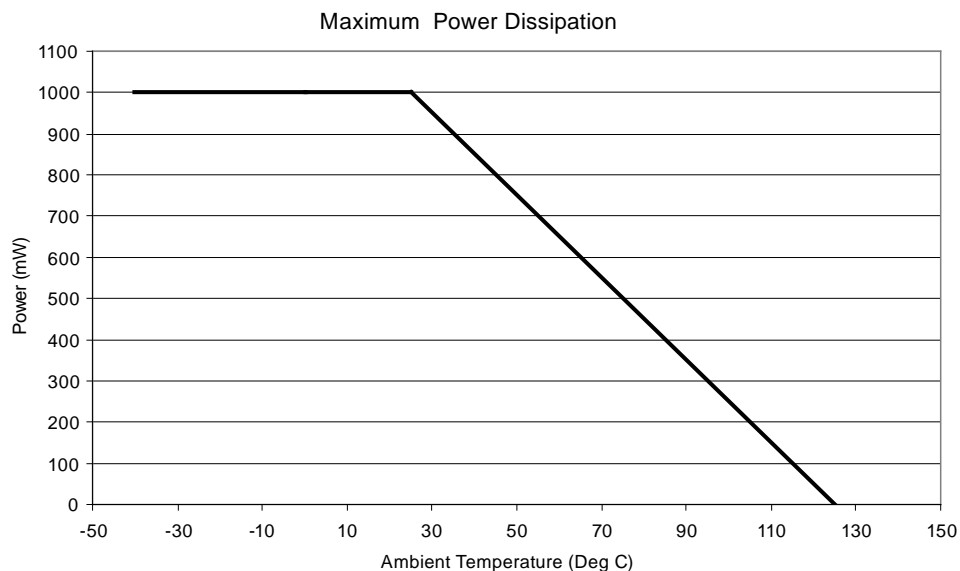

Note that the device power dissipation will most often be a maximum at minimum supply voltage. It will also increase if the efficiency of the circuit is low. This may result from the use of unsuitable coils, or excessive parasitic output capacitance on the switch output.

Thermal compensation of output current

High luminance LEDs often need to be supplied with a temperature compensated current in order to maintain stable and reliable operation at all drive levels. The LEDs are usually mounted remotely from the device so, for this reason, the temperature coefficients of the internal circuits for the ZXLD1360Q have been optimized to minimize the change in output current when no compensation is employed. If output current compensation is required, it is possible to use an external temperature sensing network - normally using Negative Temperature Coefficient (NTC) thermistors and/or diodes, mounted very close to the LED(s). The output of the sensing network can be used to drive the ADJ pin in order to reduce output current with increasing temperature.

Application Information (cont.)

Layout Considerations

LX Pin

The LX pin of the device is a fast switching node, so PCB tracks should be kept as short as possible. To minimize ground 'bounce', the ground pin of the device should be soldered directly to the ground plane.

Coil and Decoupling Capacitors and Current Sense Resistor

It is particularly important to mount the coil and the input decoupling capacitor as close to the device pins as possible to minimize parasitic resistance and inductance, which will degrade efficiency. It is also important to minimize any track resistance in series with current sense resistor R_S . It is best to connect V_{IN} directly to one end of R_S and I_{sense} directly to the opposite end of R_S with no other currents flowing in these tracks. It is important that the cathode current of the Schottky diode does not flow in a track between R_S and V_{IN} as this may give an apparent higher measure of current than is actual because of track resistance.

ADJ Pin

The ADJ pin is a high impedance input for voltages up to 1.35V, so, when left floating, PCB tracks to this pin should be as short as possible to reduce noise pickup. A 100nF capacitor from the ADJ pin to ground will reduce frequency modulation of the output under these conditions. An additional series 10k Ω resistor can also be used when driving the ADJ pin from an external circuit (see below). This resistor will provide filtering for low frequency noise and provide protection against high voltage transients.

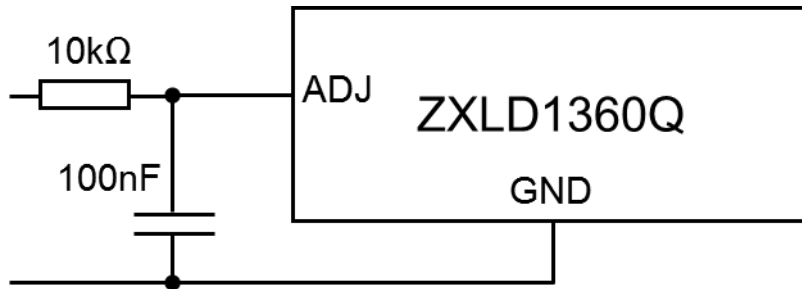

High Voltage Tracks

Avoid running any high voltage tracks close to the ADJ pin, to reduce the risk of leakage currents due to board contamination. The ADJ pin is soft-clamped for voltages above 1.35V to desensitize it to leakage that might raise the ADJ pin voltage and cause excessive output current. However, a ground ring placed around the ADJ pin is recommended to minimize changes in output current under these conditions.

Evaluation PCB

A number of ZXLD1360 evaluation boards are available on request for qualified opportunities.

Application Information (cont.)

Dimming output current using PWM

Low Frequency PWM Mode

When the ADJ pin is driven with a low frequency PWM signal (eg 100Hz), with a high level voltage V_{ADJ} and a low level of zero, the output of the internal low pass filter will swing between 0V and V_{ADJ} , causing the input to the shutdown circuit to fall below its turn-off threshold (200mV nom) when the ADJ pin is low. This will cause the output current to be switched on and off at the PWM frequency, resulting in an average output current I_{OUTavg} proportional to the PWM duty cycle (See Figure 3 - Low frequency PWM operating waveforms).

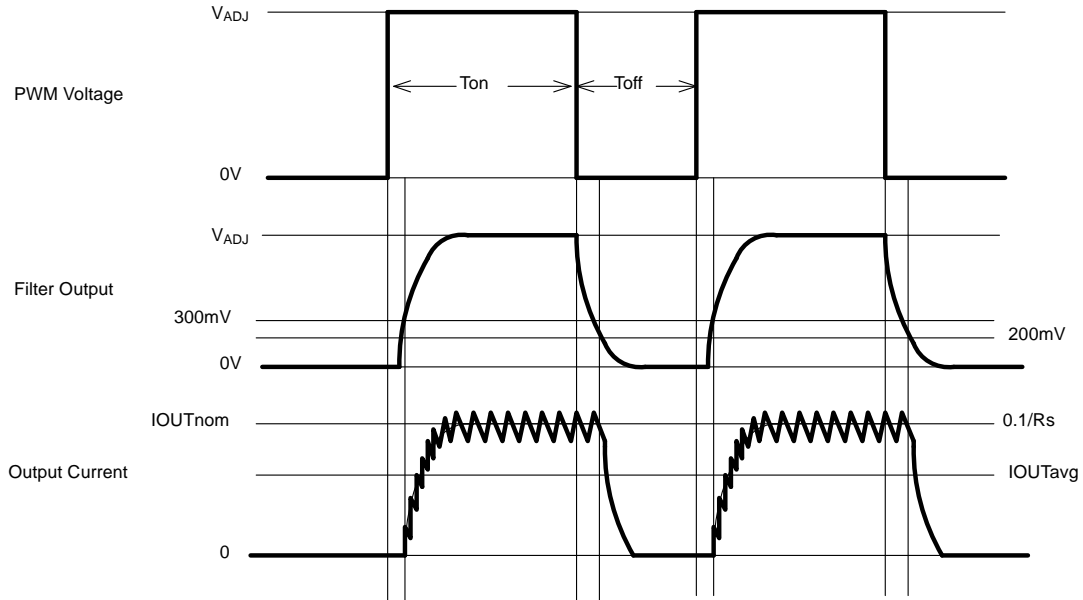

Figure 3 Low Frequency PWM Operating Waveforms

The average value of output current in this mode is given by:

$$I_{OUTavg} = 0.1D_{PWM}/R_S \text{ [for } D_{PWM} > 0.01]$$

This mode is preferable if optimum LED 'whiteness' is required. It will also provide the widest possible dimming range (approx. 100:1) and higher efficiency at the expense of greater output ripple.

Note that the low pass filter introduces a small error in the output duty cycle due to the difference between the start-up and shut-down times. This time difference is a result of the 200mV shutdown threshold and the rise and fall times at the output of the filter. To minimize this error, the PWM frequency should be as low as possible consistent with avoiding flicker in the LED(s).

Application Information (cont.)

High Frequency PWM mode

At PWM frequencies above 10kHz and for duty cycles above 0.16, the output of the internal low pass filter will contain a DC component that is always above the shutdown threshold. This will maintain continuous device operation and the nominal average output current will be proportional to the average voltage at the output of the filter, which is directly proportional to the duty cycle (See Figure 4 – High frequency PWM operating waveforms). For best results, the PWM frequency should be maintained above the minimum specified value of 10kHz, in order to minimize ripple at the output of the filter. The shutdown comparator has approximately 50mV of hysteresis, to minimize erratic switching due to this ripple. An upper PWM frequency limit of approximately one tenth of the operating frequency is recommended, to avoid excessive output modulation and to avoid injecting excessive noise into the internal reference.

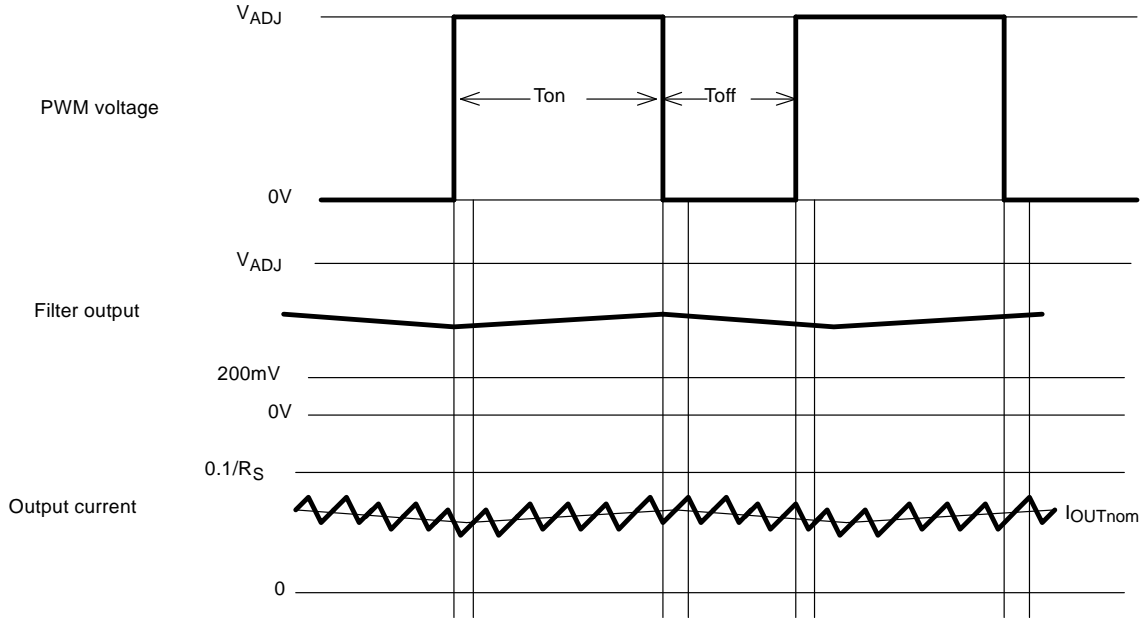

Figure 4 High Frequency PWM Operating Waveforms

The nominal average value of output current in this mode is given by:

$I_{OUTNOM} \gg 0.1 D_{PWM} / R_S$ [for $D_{PWM} > 0.16$]

This mode will give minimum output ripple and reduced radiated emission, but with a reduced dimming range (approximately 5:1). The restricted dimming range is a result of the device being turned off when the DC component on the filter output falls below 200mV.

Open and Shorted LED Protection

The ZXLD1360Q has by default open LED protection. If the LEDs should become open circuit the ZXLD1360Q will stop oscillating;

The SET pin will rise to V_{IN} and the SW pin will then fall to GND.
No excessive voltages will be seen by the ZXLD1360Q.

If the LEDs should become shorted together, the ZXLD1360Q will continue to switch. However, the duty cycle at which it will operate will change dramatically and the switching frequency will most likely decrease.

The on-time of the internal power MOSFET switch will be significantly reduced because almost all of the input voltage is now developed across the inductor.

The off-time will be significantly increased because the reverse voltage across the inductor is now just the Schottky diode voltage, causing a much slower decay in inductor current.

During this condition the inductor current will remain within its controlled levels and no excessive heat will be generated within the ZXLD1360Q.

Ordering Information

Device	Packaging (Note 9)	Part Mark	Package Code	Packing: 7" Tape and Reel			Qualification (Note 10)
				Quantity per reel	Reel width	Part Number Suffix	
ZXLD1360QET5TA	TSOT25	1360	ET5	3,000	8mm	TA	Automotive Grade

- Notes: 9. Pad layout as shown on Diodes Inc. suggested pad layout document AP02001, which can be found on our website at <http://www.diodes.com/datasheets/ap02001.pdf>.
 10. ZXLD1360Q has been qualified to AEC-Q100 grade 1 and is classified as "Automotive Grade" supporting PPAP documentation. See ZXLD1360 datasheet for commercial qualified versions.

Marking Information

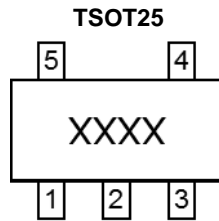

XXXX : Identification code: 1360

Package Outline Dimensions

Please see AP02002 at <http://www.diodes.com/datasheets/ap02002.pdf> for the latest version.

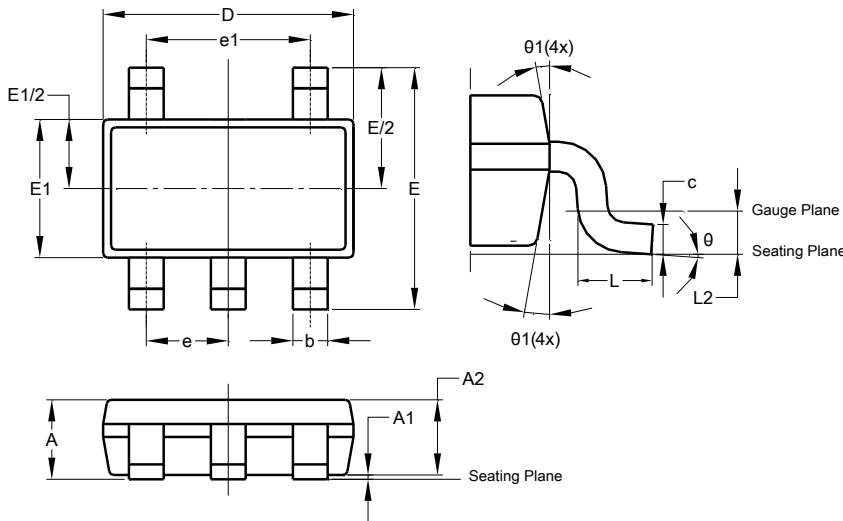

TSOT25			
Dim	Min	Max	Typ
A	-	1.00	-
A1	0.01	0.10	-
A2	0.84	0.90	-
b	0.30	0.45	-
c	0.12	0.20	-
D	-	-	2.90
E	-	-	2.80
E1	-	-	1.60
e	0.95 BSC		
e1	1.90 BSC		
L	0.30	0.50	
L2	0.25 BSC		
theta	0°	8°	4°
theta1	4°	12°	-
All Dimensions in mm			

Suggested Pad Layout

Please see AP02001 at <http://www.diodes.com/datasheets/ap02001.pdf> for the latest version.

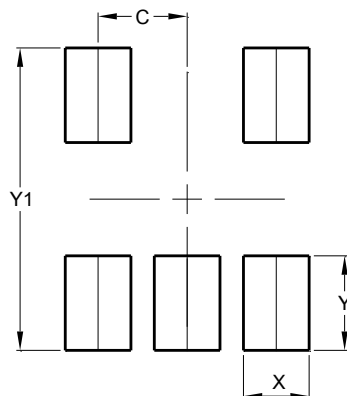

Dimensions	Value (in mm)
C	0.950
X	0.700
Y	1.000
Y1	3.199

IMPORTANT NOTICE

DIODES INCORPORATED MAKES NO WARRANTY OF ANY KIND, EXPRESS OR IMPLIED, WITH REGARDS TO THIS DOCUMENT, INCLUDING, BUT NOT LIMITED TO, THE IMPLIED WARRANTIES OF MERCHANTABILITY AND FITNESS FOR A PARTICULAR PURPOSE (AND THEIR EQUIVALENTS UNDER THE LAWS OF ANY JURISDICTION).

Diodes Incorporated and its subsidiaries reserve the right to make modifications, enhancements, improvements, corrections or other changes without further notice to this document and any product described herein. Diodes Incorporated does not assume any liability arising out of the application or use of this document or any product described herein; neither does Diodes Incorporated convey any license under its patent or trademark rights, nor the rights of others. Any Customer or user of this document or products described herein in such applications shall assume all risks of such use and will agree to hold Diodes Incorporated and all the companies whose products are represented on Diodes Incorporated website, harmless against all damages.

Diodes Incorporated does not warrant or accept any liability whatsoever in respect of any products purchased through unauthorized sales channel.

Should Customers purchase or use Diodes Incorporated products for any unintended or unauthorized application, Customers shall indemnify and hold Diodes Incorporated and its representatives harmless against all claims, damages, expenses, and attorney fees arising out of, directly or indirectly, any claim of personal injury or death associated with such unintended or unauthorized application.

Products described herein may be covered by one or more United States, international or foreign patents pending. Product names and markings noted herein may also be covered by one or more United States, international or foreign trademarks.

This document is written in English but may be translated into multiple languages for reference. Only the English version of this document is the final and determinative format released by Diodes Incorporated.

LIFE SUPPORT

Diodes Incorporated products are specifically not authorized for use as critical components in life support devices or systems without the express written approval of the Chief Executive Officer of Diodes Incorporated. As used herein:

A. Life support devices or systems are devices or systems which:

1. are intended to implant into the body, or
2. support or sustain life and whose failure to perform when properly used in accordance with instructions for use provided in the labeling can be reasonably expected to result in significant injury to the user.

B. A critical component is any component in a life support device or system whose failure to perform can be reasonably expected to cause the failure of the life support device or to affect its safety or effectiveness.

Customers represent that they have all necessary expertise in the safety and regulatory ramifications of their life support devices or systems, and acknowledge and agree that they are solely responsible for all legal, regulatory and safety-related requirements concerning their products and any use of Diodes Incorporated products in such safety-critical, life support devices or systems, notwithstanding any devices- or systems-related information or support that may be provided by Diodes Incorporated. Further, Customers must fully indemnify Diodes Incorporated and its representatives against any damages arising out of the use of Diodes Incorporated products in such safety-critical, life support devices or systems.

Copyright © 2014, Diodes Incorporated

www.diodes.com