

TPS65251-x 4.5-V to 18-V Input, High Current, Synchronous Step Down Three Buck Switchers With Integrated FET

1 Features

- Wide Input Supply Voltage Range (4.5 to 18 V)
- Output Range 0.8 V to $V_{IN} - 1$ V
- Continuous Loading: 3 A (Buck 1), 2 A (Buck 2 and 3)
- Maximum Current: 3.5 A (Buck 1), 2.5 A (Buck 2 and 3)
- Adjustable Switching Frequency 300 kHz to 2.2 MHz Set by External Resistor
- Dedicated Enable for Each Buck
- External Synchronization Pin for Oscillator
- Adjustable Current Limit Set by External Resistor
- Soft-Start Pins
- Current-Mode Control With Simple Compensation Circuit
- Power Good
- Automatic PFM/PWM Operation
- VQFN Package, 40-Pin 6-mm x 6-mm RHA

2 Applications

- Set Top Boxes
- Blu-ray™ DVD
- DVR
- DTV
- Car Audio/Video
- Security Camera

3 Description

The TPS65251-x features three synchronous wide-input range, high-efficiency buck converters. The converters are designed to simplify its application while giving the designer the option to optimize their usage according to the target application.

The converters can operate in 5-, 9-, 12- or 15-V systems and have integrated power transistors. The output voltage can be set externally using a resistor divider to any value between 0.8 V and close to the input supply. Each converter features an enable pin that allows a delayed start-up for sequencing purposes, soft-start pin that allows adjustable soft-start time by choosing the soft-start capacitor, and a current limit (RLIMx) pin that enables the designer to adjust current limit by selecting an external resistor and optimize the choice of inductor. The current mode control allows a simple RC compensation.

The switching frequency of the converters can either be set with an external resistor connected to ROsc pin or can be synchronized to an external clock connected to the SYNC pin if needed. The switching regulators are designed to operate from 300 kHz to 2.2 MHz. 180° out-of-phase operation between Buck 1 and Buck 2, 3 (Buck 2 and 3 run in phase) minimizes the input filter requirements.

TPS65251-x features a supervisor circuit that monitors each converter output. The PGOOD pin is asserted when sequencing is done, all PG signals are reported and a selectable end of reset time lapses. The polarity of the PGOOD signal is active high.

All converters feature an automatic low-power pulse PFM skipping mode, which improves efficiency during light loads and standby operation, while ensuring a very-low output ripple, allowing for a value of less than 2% at low output voltages.

Device Information⁽¹⁾

| PART NUMBER | PACKAGE | BODY SIZE (NOM) |
|-------------|-----------|-------------------|
| TPS65251-1 | VQFN (40) | 6.00 mm x 6.00 mm |
| TPS65251-2 | | |
| TPS65251-3 | | |

(1) For all available packages, see the orderable addendum at the end of the data sheet.

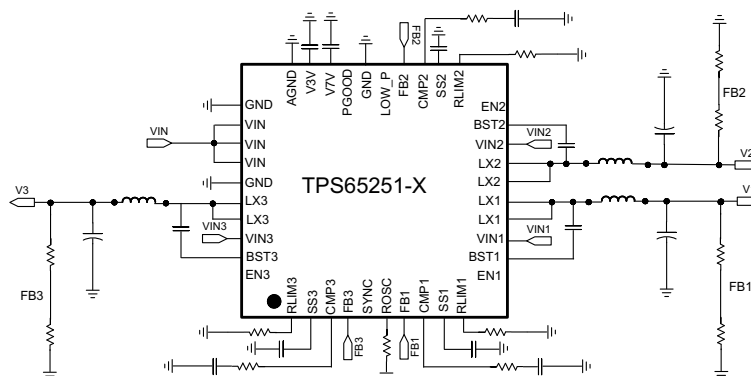

Table of Contents

| | | | |
|--|-----------|--|-----------|
| 1 Features | 1 | 7.2 Functional Block Diagram | 11 |
| 2 Applications | 1 | 7.3 Feature Description..... | 12 |
| 3 Description | 1 | 7.4 Device Functional Modes..... | 15 |
| 4 Revision History | 2 | 8 Application and Implementation | 16 |
| 5 Pin Configuration and Functions | 3 | 8.1 Application Information..... | 16 |
| 6 Specifications | 5 | 8.2 Typical Application | 16 |
| 6.1 Absolute Maximum Ratings | 5 | 9 Power Supply Recommendations | 29 |
| 6.2 ESD Ratings..... | 5 | 10 Layout | 29 |
| 6.3 Recommended Operating Conditions..... | 5 | 10.1 Layout Guidelines | 29 |
| 6.4 Thermal Information | 5 | 10.2 Layout Example | 30 |
| 6.5 Electrical Characteristics..... | 6 | 11 Device and Documentation Support | 31 |
| 6.6 Typical Characteristics for Buck 1..... | 8 | 11.1 Related Links | 31 |
| 6.7 Typical Characteristics for Buck 2..... | 9 | 11.2 Trademarks | 31 |
| 6.8 Typical Characteristics for Buck 3..... | 10 | 11.3 Electrostatic Discharge Caution..... | 31 |
| 7 Detailed Description | 11 | 11.4 Glossary | 31 |
| 7.1 Overview | 11 | 12 Mechanical, Packaging, and Orderable Information | 31 |

4 Revision History

Changes from Original (January 2015) to Revision A

Page

| | |
|--|----------|
| • Updated device status to production data | 1 |
|--|----------|

5 Pin Configuration and Functions

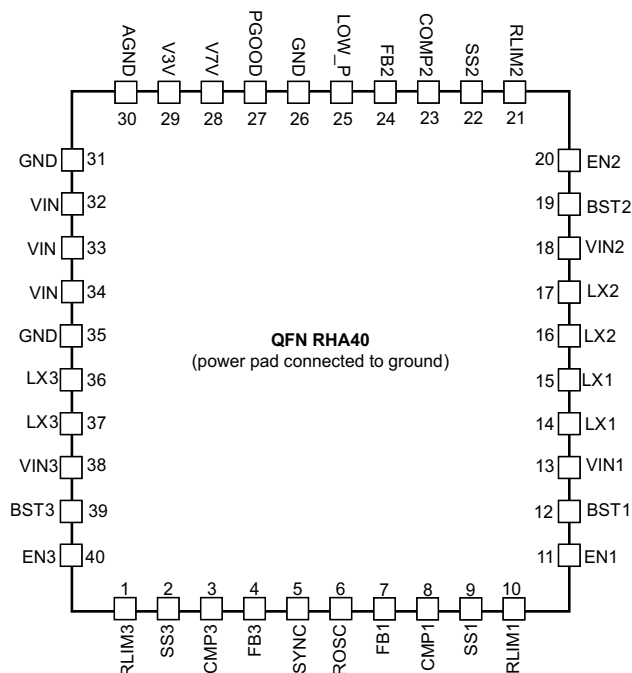

Pin Functions

| PIN | | I/O | DESCRIPTION |
|-------|-----|-----|--|
| NAME | NO. | | |
| RLIM3 | 1 | I | Current limit setting for Buck 3. Fit a resistor from this pin to ground to set the peak current limit on the output inductor. |
| SS3 | 2 | I | Soft-start pin for Buck 3. Fit a small ceramic capacitor to this pin to set the converter soft-start time. |
| COMP3 | 3 | O | Compensation for Buck 3. Fit a series RC circuit to this pin to complete the compensation circuit of this converter. |
| FB3 | 4 | I | Feedback input for Buck 3. Connect a divider set to 0.8 V from the output of the converter to ground. |
| SYNC | 5 | I | Synchronous clock input. If there is a sync clock in the system, connect to the pin. When not used, connect to GND. |
| ROSC | 6 | I | Oscillator set. This resistor sets the frequency of the internal autonomous clock. If external synchronization is used, the resistor should be fitted and set to about 70% of external clock frequency. |
| FB1 | 7 | I | Feedback pin for Buck 1. Connect a divider set to 0.8 V from the output of the converter to ground. |
| COMP1 | 8 | O | Compensation pin for Buck 1. Fit a series RC circuit to this pin to complete the compensation circuit of this converter. |
| SS1 | 9 | I | Soft-start pin for Buck 1. Fit a small ceramic capacitor to this pin to set the converter soft-start time. |
| RLIM1 | 10 | I | Current limit setting pin for Buck 1. Fit a resistor from this pin to ground to set the peak current limit on the output inductor. |
| EN1 | 11 | I | Enable pin for Buck 1. A low-level signal on this pin disables it. If pin is left open, a weak internal pull-up to V3V allows for automatic enable. For a delayed start-up, add a small ceramic capacitor from this pin to ground. |
| BST1 | 12 | I | Bootstrap capacitor for Buck 1. Fit a 47-nF ceramic capacitor from this pin to the switching node. |
| VIN1 | 13 | I | Input supply for Buck 1. Fit a 10- μ F ceramic capacitor close to this pin. |
| LX1 | 14 | O | Switching node for Buck 1 |
| | 15 | | |
| LX2 | 16 | O | Switching node for Buck 2 |
| | 17 | | |
| VIN2 | 18 | I | Input supply for Buck 2. Fit a 10- μ F ceramic capacitor close to this pin. |
| BST2 | 19 | I | Bootstrap capacitor for Buck 2. Fit a 47-nF ceramic capacitor from this pin to the switching node. |

Pin Functions (continued)

| PIN | | I/O | DESCRIPTION |
|-------|-----|-----|--|
| NAME | NO. | | |
| EN2 | 20 | I | Enable pin for Buck 2. A low-level signal on this pin disables it. If pin is left open, a weak internal pull-up to V3V allows for automatic enable. For a delayed start-up, add a small ceramic capacitor from this pin to ground. |
| RLIM2 | 21 | I | Current limit setting for Buck 2. Fit a resistor from this pin to ground to set the peak current limit on the output inductor. |
| SS2 | 22 | I | Soft-start pin for Buck 2. Fit a small ceramic capacitor to this pin to set the converter soft-start time. |
| COMP2 | 23 | O | Compensation pin for Buck 2. Fit a series RC circuit to this pin to complete the compensation circuit of this converter. |
| FB2 | 24 | I | Feedback input for Buck 2. Connect a divider set to 0.8 V from the output of the converter to ground. |
| LOW_P | 25 | I | Low-power operation mode (active-high) input for TPS65251 |
| GND | 26 | | Ground pin |
| PGOOD | 27 | O | Power good. Open-drain output asserted after all converters are sequenced and within regulation. Polarity is factory selectable (active-high default). |
| V7V | 28 | O | Internal supply. Connect a 10- μ F ceramic capacitor from this pin to ground. |
| V3V | 29 | O | Internal supply. Connect a 3.3- to 10- μ F ceramic capacitor from this pin to ground. |
| AGND | 30 | | Analog ground. Connect all GND pins and the power pad together. |
| GND | 31 | | Ground pin |
| VIN | 32 | I | Input supply |
| | 33 | | |
| | 34 | | |
| GND | 35 | | Ground pin |
| LX3 | 36 | O | Switching node for Buck 3 |
| | 37 | | |
| VIN3 | 38 | | Input supply for Buck 3. Fit a 10- μ F ceramic capacitor close to this pin. |
| BST3 | 39 | I | Bootstrap capacitor for Buck 3. Fit a 47-nF ceramic capacitor from this pin to the switching node. |
| EN3 | 40 | I | Enable pin for Buck 3. A low-level signal on this pin disables it. If pin is left open, a weak internal pull-up to V3V allows for automatic enable. For a delayed start-up, add a small ceramic capacitor from this pin to ground. |
| PAD | — | — | Power pad. Connect to ground. |

6 Specifications

6.1 Absolute Maximum Ratings ⁽¹⁾

over operating free-air temperature range (unless otherwise noted)

| | | MIN | MAX | UNIT |
|------------------|---|------|-----|------|
| Voltage | VIN1, VIN2, VIN3, LX1, LX2, LX3 | -0.3 | 18 | V |
| | LX1, LX2, LX3 (maximum withstand voltage transient <10 ns) | -1 | 18 | V |
| | BST1, BST2, BST3, referenced to Lx pin | -0.3 | 7 | V |
| | V7V | -0.3 | 7 | V |
| | V3V, RLIM1, RLIM2, RLIM3, EN1, EN2, EN3, SS1, SS2, SS3, FB1, FB2, FB3, PGOOD, SYNC, ROOSC, RST_IN, LOW_P, COMP1, COMP2, COMP3 | -0.3 | 3.6 | V |
| | AGND, GND | -0.3 | 0.3 | V |
| T _J | Operating virtual junction temperature | -40 | 125 | °C |
| T _{stg} | Storage temperature | -55 | 150 | °C |

- (1) Stresses beyond those listed under "absolute maximum ratings" may cause permanent damage to the device. These are stress ratings only, and functional operation of the device at these or any other conditions beyond those indicated under "recommended operating conditions" is not implied. Exposure to absolute-maximum-rated conditions for extended periods may affect device reliability.

6.2 ESD Ratings

| | | | VALUE | UNIT |
|--------------------|-------------------------|--|-------|------|
| V _(ESD) | Electrostatic discharge | Human body model (HBM), per ANSI/ESDA/JEDEC JS-001, all pins ⁽¹⁾ | ±2000 | V |
| | | Charged device model (CDM), per JEDEC specification JESD22-C101, all pins ⁽²⁾ | ±500 | |

- (1) JEDEC document JEP155 states that 500-V HBM allows safe manufacturing with a standard ESD control process.

- (2) JEDEC document JEP157 states that 250-V CDM allows safe manufacturing with a standard ESD control process.

6.3 Recommended Operating Conditions

over operating free-air temperature range (unless otherwise noted)

| | | MIN | NOM | MAX | UNIT |
|-----------------|-------------------------|-----|-----|-----|------|
| V _{IN} | Input operating voltage | 4.5 | | 18 | V |
| T _J | Junction temperature | -40 | | 125 | °C |

6.4 Thermal Information

| THERMAL METRIC ⁽¹⁾ | | TPS65251-x | UNIT |
|-------------------------------|--|------------|------|
| | | RHA | |
| | | 40 PINS | |
| R _{θJA} | Junction-to-ambient thermal resistance | 32.7 | °C/W |
| R _{θJC(top)} | Junction-to-case (top) thermal resistance | 21.4 | |
| R _{θJB} | Junction-to-board thermal resistance | 8.3 | |
| Ψ _{JT} | Junction-to-top characterization parameter | 0.2 | |
| Ψ _{JB} | Junction-to-board characterization parameter | N/A | |
| R _{θJC(bot)} | Junction-to-case (bottom) thermal resistance | 2 | |

- (1) For more information about traditional and new thermal metrics, see the *IC Package Thermal Metrics* application report, [SPRA953](#).

6.5 Electrical Characteristics

 $T_J = -40^{\circ}\text{C}$ to 125°C , $V_{IN} = 12\text{ V}$, $f_{SW} = 500\text{ Hz}$ (unless otherwise noted)

| PARAMETER | | TEST CONDITIONS | MIN | TYP | MAX | UNIT |
|--|-------------------------------------|--|-----------------------|------|------|---------------|
| INPUT SUPPLY UVLO AND INTERNAL SUPPLY VOLTAGE | | | | | | |
| V_{IN} | Input voltage range | | 4.5 | | 18 | V |
| IDD_{SDN} | Shutdown | EN pin = Low for all converters | | 175 | | μA |
| IDD_Q | Quiescent, low power disabled (Lo) | Converters enabled, no load Buck 1 = 3.3 V, Buck 2 = 2.5 V, Buck 3 = 7.5 V, $L = 4.7\ \mu\text{H}$, $f_{SW} = 800\text{ kHz}$ | | 20 | | mA |
| $IDD_{Q_LOW_P}$ | Quiescent, low power enabled (Hi) | Converters enabled, no load Buck 1 = 3.3 V, Buck 2 = 2.5 V, Buck 3 = 7.5 V, $L = 4.7\ \mu\text{H}$, $f_{SW} = 800\text{ kHz}$ | | 1 | | mA |
| $UVLO_{VIN}$ | V_{IN} undervoltage lockout | Rising V_{IN} | | 4.22 | | V |
| | | Falling V_{IN} | | 4.1 | | |
| $UVLO_{DEGLITCH}$ | | Both edges | | 110 | | μs |
| V_{3p3} | Internal biasing supply | | | 3.3 | | V |
| V_{7V} | Internal biasing supply | | | 6.25 | | V |
| $V7V_{UVLO}$ | UVLO for internal V7V rail | Rising V7V | | 3.8 | | V |
| | | Falling V7V | | 3.6 | | |
| $V7V_{UVLO_DEGLITCH}$ | | Falling edge | | 110 | | μs |
| BUCK CONVERTERS (ENABLE CIRCUIT, CURRENT LIMIT, SOFT START, SWITCHING FREQUENCY AND SYNC CIRCUIT, LOW POWER MODE) | | | | | | |
| V_{IH} | Enable threshold high | External GPIO mode, $V_{3p3} = 3.2$ to 3.4 V | $0.66 \times V_{3p3}$ | | | V |
| | Enable high level | $V_{3p3} = 3.2$ to 3.4 V , V_{ENX} rising | 1.55 | 1.67 | 1.82 | |
| V_{IL} | Enable threshold low | External GPIO mode, $V_{3p3} = 3.2$ to 3.4 V | $0.33 \times V_{3p3}$ | | | V |
| | Enable low level | $V_{3p3} = 3.2$ to 3.4 V , V_{ENX} falling | 0.98 | 1.10 | 1.24 | |
| R_{EN_DIS} | Enable discharge resistor | | -25% | 2.1 | 25% | k Ω |
| ICH_{EN} | Pullup current enable pin | | | 1.1 | | μA |
| t_D | Discharge time enable pins | Power-up | | 10 | | ms |
| I_{SS} | Soft-start pin current source | | | 5 | | μA |
| F_{SW_BK} | Converter switching frequency range | Set externally with resistor | 0.3 | | 2.2 | MHz |
| R_{FSW} | Frequency setting resistor | Depending on set frequency | 50 | | 600 | k Ω |
| f_{SW_TOL} | Internal oscillator accuracy | $f_{SW} = 800\text{ kHz}$ | -10% | | 10% | |
| V_{SYNCH} | External clock threshold high | $V_{3p3} = 3.3\text{ V}$ | | | 1.24 | V |
| V_{SYNCL} | External clock threshold low | $V_{3p3} = 3.3\text{ V}$ | 1.55 | | | V |
| $SYNC_{RANGE}$ | Synchronization range | | 0.2 | | 2.2 | MHz |
| $SYNC_{CLK_MIN}$ | Sync signal minimum duty cycle | | 40% | | | |
| $SYNC_{CLK_MAX}$ | Sync signal maximum duty cycle | | | | 60% | |
| $VI_{H_LOW_P}$ | Low power mode threshold high | $V_{3p3} = 3.3\text{ V}$, V_{ENX} rising | 1.55 | | | V |
| VIL_{LOW_P} | Low power mode threshold Low | $V_{3p3} = 3.3\text{ V}$, V_{ENX} falling | | | 1.24 | V |

Electrical Characteristics (continued)

 $T_J = -40^{\circ}\text{C}$ to 125°C , $V_{IN} = 12\text{ V}$, $f_{SW} = 500\text{ Hz}$ (unless otherwise noted)

| PARAMETER | | TEST CONDITIONS | MIN | TYP | MAX | UNIT |
|---|---|---|-----|------|-----|--------------------|
| FEEDBACK, REGULATION, OUTPUT STAGE | | | | | | |
| V_{FB} | Feedback voltage | $V_{IN} = 12\text{ V}$, $T_J = 25^{\circ}\text{C}$ | -1% | 0.8 | 1% | V |
| | | $V_{IN} = 4.5$ to 18 V | -2% | 0.8 | 2% | |
| I_{FB} | Feedback leakage current | | | | 50 | nA |
| t_{ON_MIN} | Minimum on-time (current sense blanking) to specify output regulation | | | 70 | 100 | ns |
| $RLIM_1$ | Limit resistance range | $V_{IN} = 12\text{ V}$, $f_{SW} = 500\text{ kHz}$ | 75 | | 300 | k Ω |
| $RLIM_{2,3}$ | Limit resistance range | $V_{IN} = 12\text{ V}$, $f_{SW} = 500\text{ kHz}$ | 1.1 | | 5.1 | A |
| $ILIM_1$ | Buck1 current limit range | $V_{IN} = 12\text{ V}$, $f_{SW} = 500\text{ kHz}$ | 100 | | 300 | k Ω |
| $ILIM_2$ | Buck2 current limit range | $V_{IN} = 12\text{ V}$, $f_{SW} = 500\text{ kHz}$ | 1.2 | | 4.1 | A |
| $ILIM_3$ | Buck3 current limit range | $V_{IN} = 12\text{ V}$, $f_{SW} = 500\text{ kHz}$ | 1.2 | | 4.1 | A |
| MOSFET (BUCK 1) | | | | | | |
| H.S. Switch | Turn-on resistance high-side FET on CH1 | BOOT = 6.5 V, $T_J = 25^{\circ}\text{C}$ | | 95 | | m Ω |
| L.S. Switch | Turn-on resistance low-side FET on CH1 | $V_{IN} = 12\text{ V}$, $T_J = 25^{\circ}\text{C}$ | | 50 | | m Ω |
| MOSFET (BUCK 2) | | | | | | |
| H.S. Switch | Turn-on resistance high-side FET on CH2 | BOOT = 6.5 V, $T_J = 25^{\circ}\text{C}$ | | 120 | | m Ω |
| L.S. Switch | Turn-on resistance low-side FET on CH2 | $V_{IN} = 12\text{ V}$, $T_J = 25^{\circ}\text{C}$ | | 80 | | m Ω |
| MOSFET (BUCK 3) | | | | | | |
| H.S. Switch | Turn-on resistance high-side FET on CH3 | BOOT = 6.5 V, $T_J = 25^{\circ}\text{C}$ | | 120 | | m Ω |
| L.S. Switch | Turn-on resistance low-side FET on CH3 | $V_{IN} = 12\text{ V}$, $T_J = 25^{\circ}\text{C}$ | | 80 | | m Ω |
| ERROR AMPLIFIER | | | | | | |
| g_M | Error amplifier transconductance | $-2\text{ }\mu\text{A} < I_{COMP} < 2\text{ }\mu\text{A}$ | | 130 | | μmhos |
| g_{mPS} | COMP to ILX g_M | ILX = 0.5 A | | 10 | | A/V |
| POWER GOOD RESET GENERATOR | | | | | | |
| V_{UV_BUCKX} | Threshold voltage for buck under voltage | Output falling | | 85% | | |
| | | Output rising (PG is asserted) | | 90% | | |
| $t_{UV_deglitch}$ | Deglintch time (both edges) | Each buck | | 11 | | ms |
| t_{ON_HICCUP} | Hiccup mode ON time | V_{UV_BUCKX} asserted | | 13 | | ms |
| t_{OFF_HICCUP} | Hiccup mode OFF time | All converters disabled. After t_{OFF_HICCUP} elapses, all converters go through sequencing again. | | 11 | | ms |
| VOV_BUCKX | Threshold voltage for buck over voltage | Output rising (high-side FET is forced off) | | 106% | | |
| | | Output falling (high-side FET is allowed to switch) | | 104% | | |
| t_{RP} | Minimum reset period | TPS65251-1 | | 1000 | | ms |
| | | TPS65251-2 | | 32 | | |
| | | TPS65251-3 | | 256 | | |
| THERMAL SHUTDOWN | | | | | | |
| T_{TRIP} | Thermal shutdown trip point | Rising temperature | | 160 | | $^{\circ}\text{C}$ |
| T_{HYST} | Thermal shutdown hysteresis | Device restarts | | 20 | | $^{\circ}\text{C}$ |
| $t_{TRIP_DEGLITCH}$ | Thermal shutdown deglitch | | 100 | | 120 | μs |

6.6 Typical Characteristics for Buck 1

$T_A = 25^\circ\text{C}$, $V_{IN} = 12\text{ V}$, $V_O = 1.2\text{ V}$, $L = 4.7\ \mu\text{H}$, $C_O = 68\ \mu\text{F}$, $f_{SW} = 500\text{ Hz}$ (unless otherwise noted)

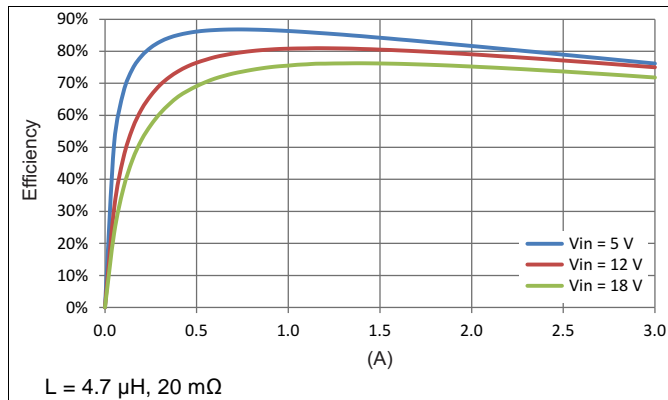

Figure 1. Efficiency, Forced PWM

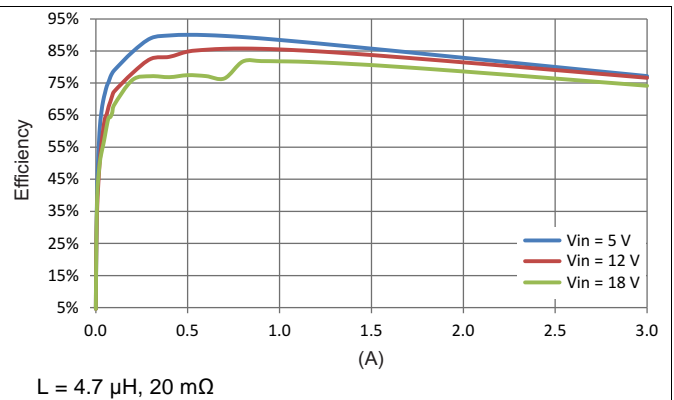

Figure 2. Efficiency, LOW_P Mode

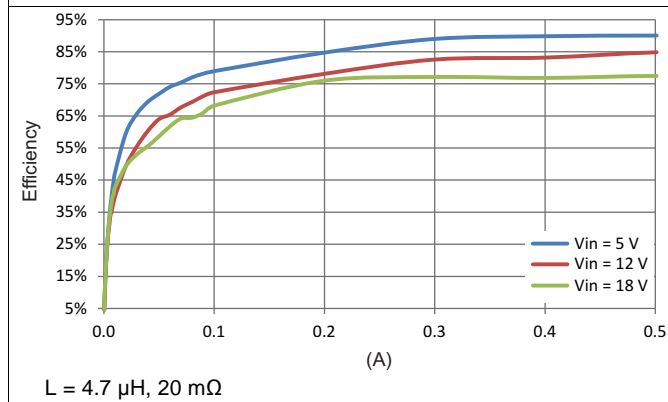

Figure 3. Efficiency, LOW_P Mode, 0 to 500 mA

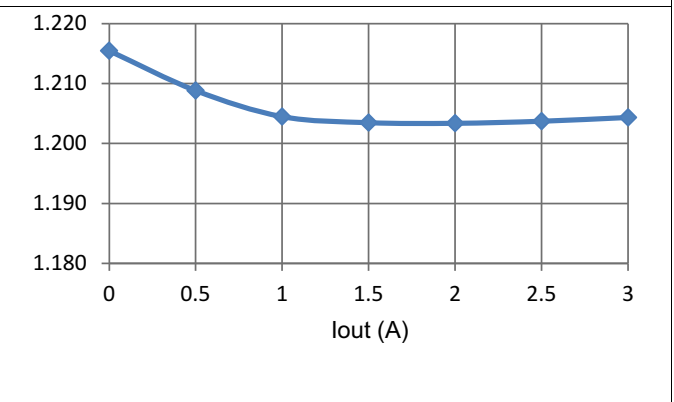

Figure 4. Load Regulation, 25°C, 1% 100-PPM Resistor

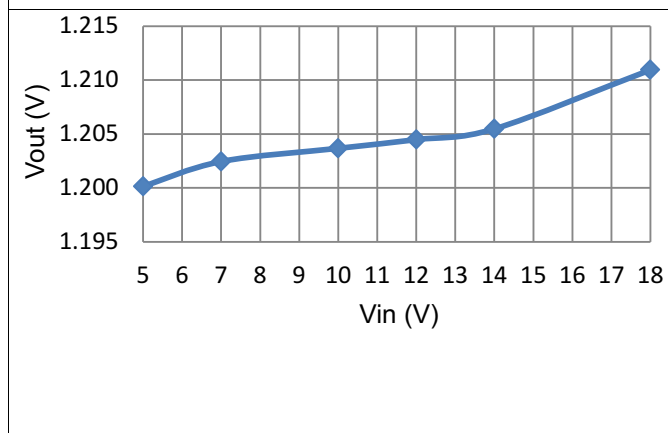

Figure 5. Line Regulation, Load = 1 A

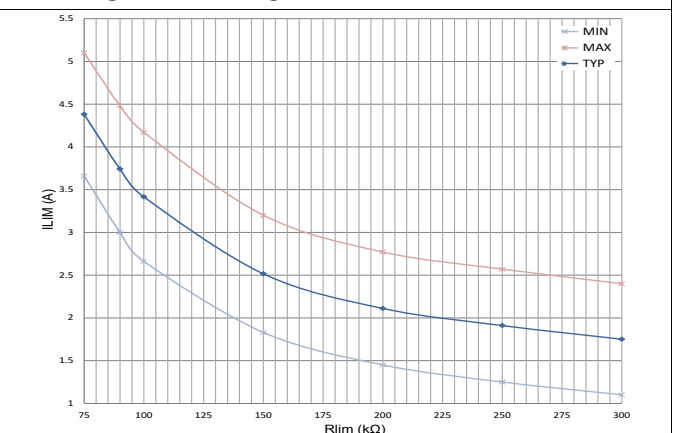

Figure 6. Current Limit $V_{IN} = 12\text{ V}$, $f_{SW} = 500\text{ KHz}$

6.7 Typical Characteristics for Buck 2

$T_A = 25^\circ\text{C}$, $V_{IN} = 12\text{ V}$, $V_O = 1.8\text{ V}$, $L = 4.7\ \mu\text{H}$, $C_O = 68\ \mu\text{F}$, $f_{SW} = 500\text{ Hz}$ (unless otherwise noted)

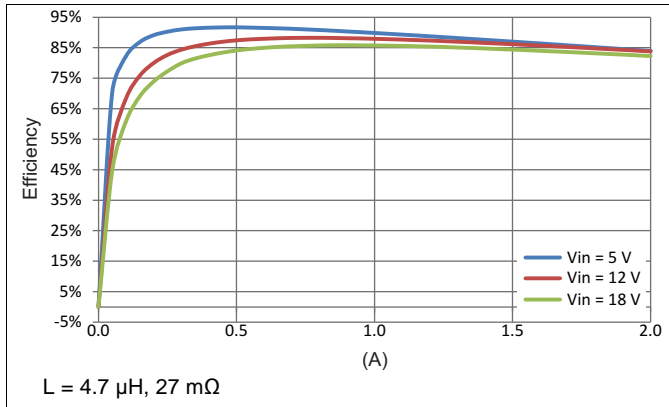

Figure 7. Efficiency, Forced PWM

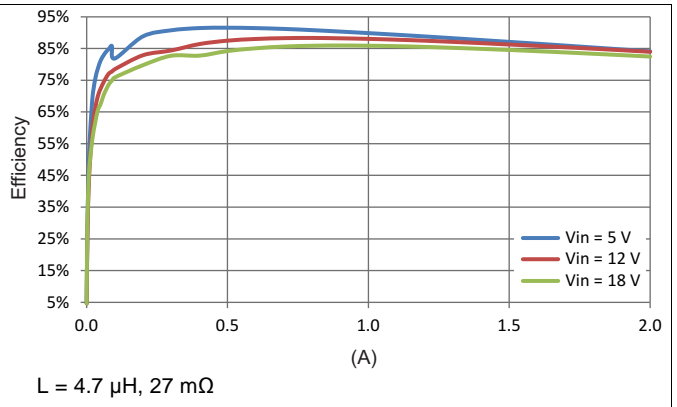

Figure 8. Efficiency, LOW_P Mode

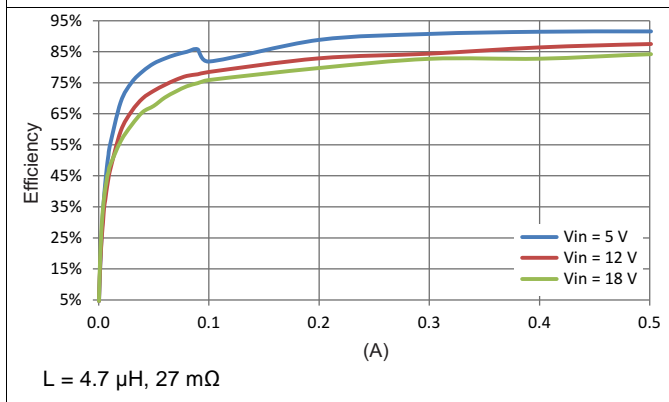

Figure 9. Efficiency, LOW_P Mode, 0 to 500 mA

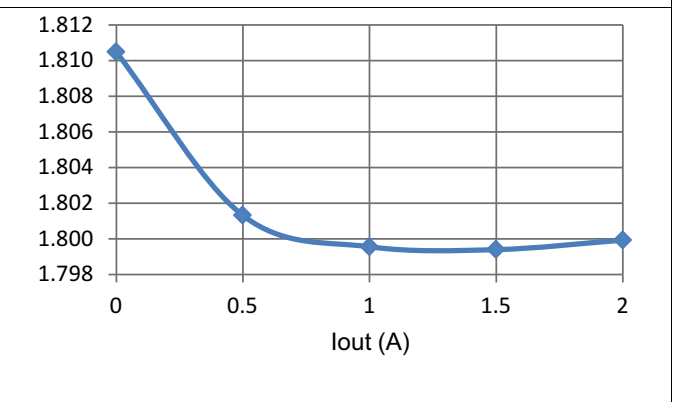

Figure 10. Load Regulation, 25°C, 1% 100-PPM Resistor

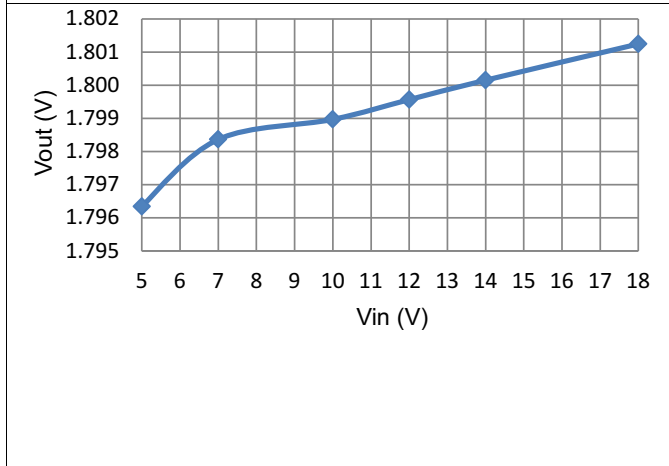

Figure 11. Line Regulation, Load = 1 A

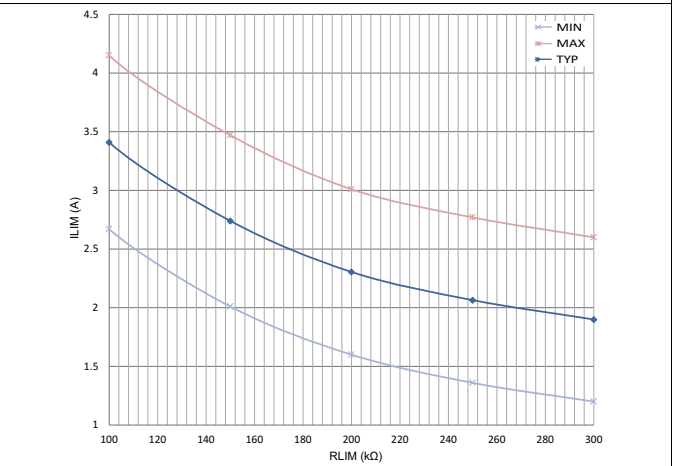

Figure 12. Current Limit $V_{IN} = 12\text{ V}$, $f_{SW} = 500\text{ kHz}$

6.8 Typical Characteristics for Buck 3

$T_A = 25^\circ\text{C}$, $V_{IN} = 12\text{ V}$, $V_O = 3.3\text{ V}$, $L = 4.7\ \mu\text{H}$, $C_O = 68\ \mu\text{F}$, $f_{SW} = 500\text{ Hz}$ (unless otherwise noted)

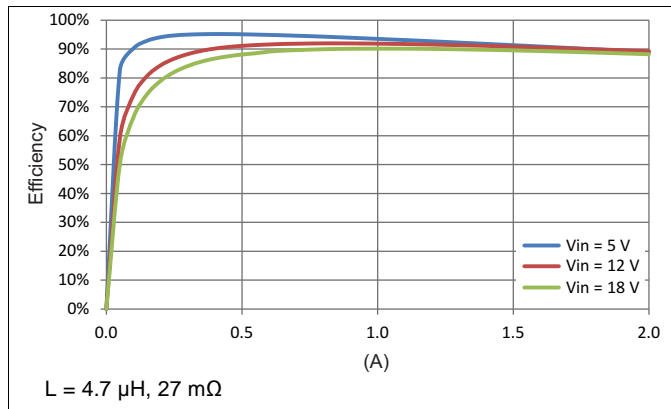

Figure 13. Efficiency, Forced PWM

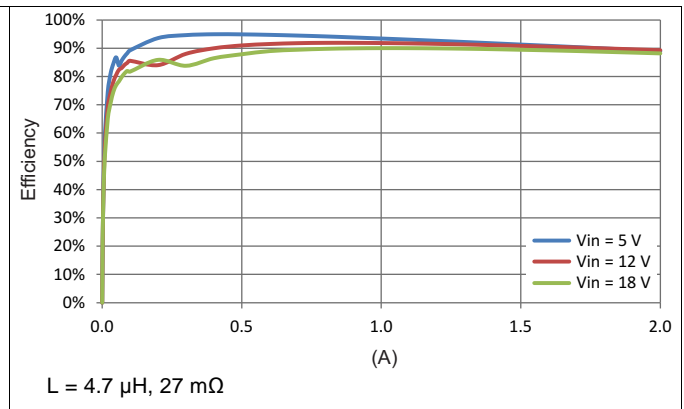

Figure 14. Efficiency, LOW_P Mode

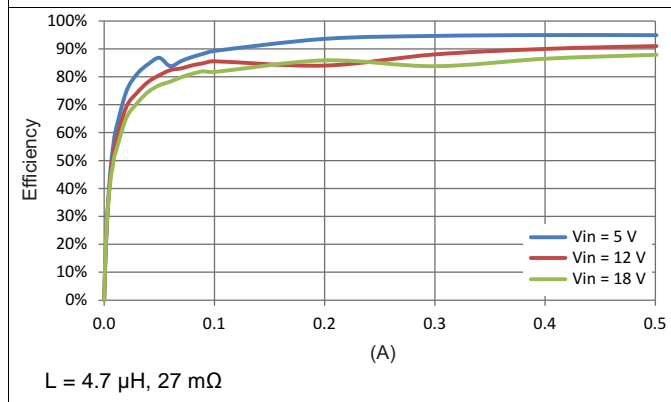

Figure 15. Efficiency, LOW_P Mode, 0 to 500 mA

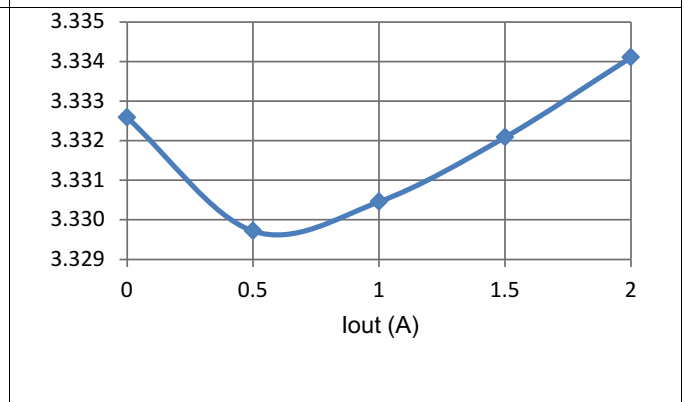

Figure 16. Load Regulation, 25°C , 1% 100-PPM Resistor

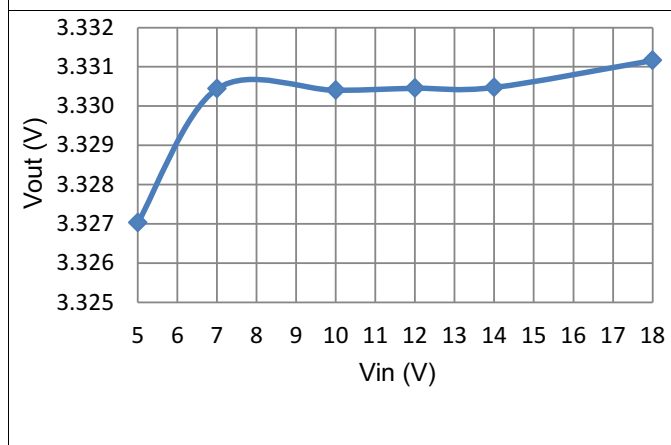

Figure 17. Line Regulation, Load = 1 A

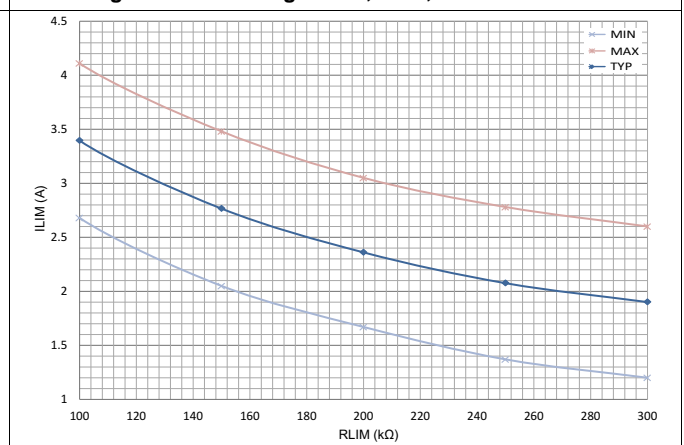

Figure 18. Current Limit $V_{IN} = 12\text{ V}$, $f_{SW} = 500\text{ KHz}$

7 Detailed Description

7.1 Overview

TPS65251-x is a power management IC with three step-down buck converters. Both high-side and low-side MOSFETs are integrated to provide fully synchronous conversion with higher efficiency. TPS65251-x can support 4.5- to 18-V input supply, high load current, 300-kHz to 2.2-MHz clocking. The buck converters have an optional PSM mode, which can improve power dissipation during light loads. Alternatively, the device implements a constant frequency mode by connecting the LOW_P pin to ground. The wide switching frequency of 300 kHz to 2.2 MHz allows for efficiency and size optimization. The switching frequency is adjustable by selecting a resistor to ground on the ROSC pin. The SYNC pin also provides a means to synchronize the power converter to an external signal. Input ripple is reduced by 180° out-of-phase operation between Buck 1 and Buck 2. Buck 3 operates in phase with Buck 2.

All three buck converters have peak current mode control which simplifies external frequency compensation. A traditional type II compensation network can stabilize the system and achieve fast transient response. Moreover, an optional capacitor in parallel with the upper resistor of the feedback divider provides one more zero and makes the crossover frequency over 100 kHz.

Each buck converter has an individual current limit, which can be set up by a resistor to ground from the RLIM pin. The adjustable current limiting enables high-efficiency design with smaller and less expensive inductors.

The device has two built-in LDO regulators. During a standby mode, the 3.3-V LDO and the 6.5-V LDO can be used to drive MCU and other active loads. By this, the system is able to turn off the three buck converters and improve the standby efficiency.

The device has a power-good comparator monitoring the output voltage. Each converter has its own soft-start and enable pins, which provide independent control and programmable soft-start.

7.2 Functional Block Diagram

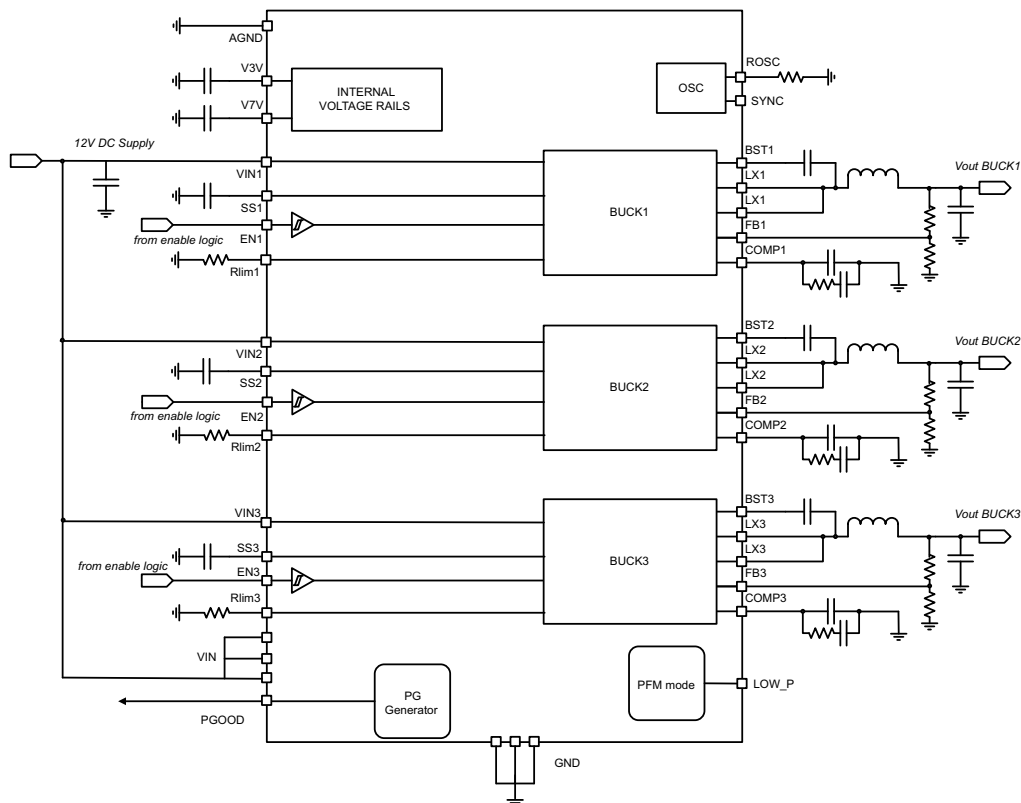

7.3 Feature Description

7.3.1 Adjustable Switching Frequency

To select the internal switching frequency, connect a resistor from ROSC to ground. [Figure 19](#) shows the required resistance for a given switching frequency.

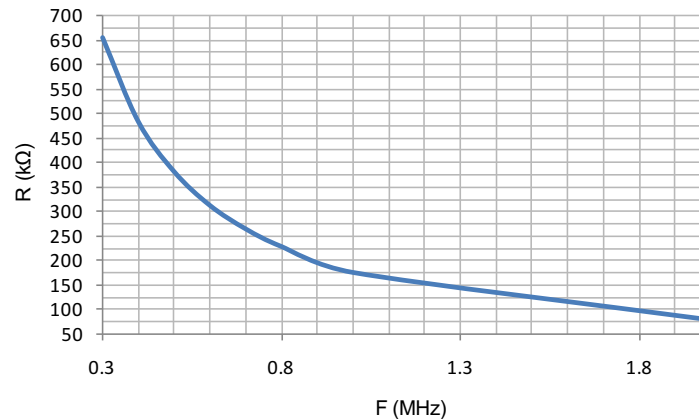

Figure 19. ROSC vs Switching Frequency

$$R_{\text{OSC}} (\text{k}\Omega) = 174 \times f (\text{MHz})^{-1.122} \quad (1)$$

For operation at 800 kHz, a 230-kΩ resistor is required.

7.3.2 Synchronization

The status of the SYNC pin is ignored during start-up and the TPS65251's control only synchronizes to an external signal after the PGOOD signal is asserted. The status of the SYNC pin is ignored during start-up and the TPS65251 only synchronizes to an external clock if the PGOOD signal is asserted. When synchronization is applied, the PWM oscillator frequency must be lower than the sync pulse frequency to allow the external signal trumping the oscillator pulse reliably. When synchronization is not applied, the SYNC pin should be connected to ground.

7.3.3 Out-of-Phase Operation

Buck 1 has a low conduction resistance compared to Buck 2 and 3. Normally Buck 1 is used to drive higher system loads. Buck 2 and 3 are used to drive some peripheral loads like I/O and line drivers. The combination of Buck 2's and Buck 3's loads may be on par with Buck 1's load. To reduce input ripple current, Buck 2 operates in phase with Buck 3; Buck 1 and Buck 2 operate 180° out-of-phase. This enables the system, having less input ripple, to lower component cost, save board space, and reduce EMI.

7.3.4 Delayed Start-Up

If a delayed start-up is required on any of the buck converters, fit a ceramic capacitor to the ENx pins. The delay added is approximately 1.67 ms per nF connected to the pin. Note that the EN pins have a weak 1-μA pull-up to the 3V3 rail.

7.3.5 Soft-Start Time

The device has an internal pullup current source of 5 μA that charges an external slow-start capacitor to implement a slow-start time. [Equation 2](#) shows how to select a slow-start capacitor based on an expected slow-start time. The voltage reference (V_{REF}) is 0.8 V and the slow-start charge current (I_{SS}) is 5 μA. The soft-start circuit requires 1 nF per 200 μs to be connected at the SS pin. A 1-ms soft-start time is implemented for all converters fitting 4.7 nF to the relevant pins.

$$t_{\text{SS}} (\text{ms}) = V_{\text{REF}} (\text{V}) \times \left(\frac{C_{\text{SS}} (\text{nF})}{I_{\text{SS}} (\mu\text{A})} \right) \quad (2)$$

Feature Description (continued)

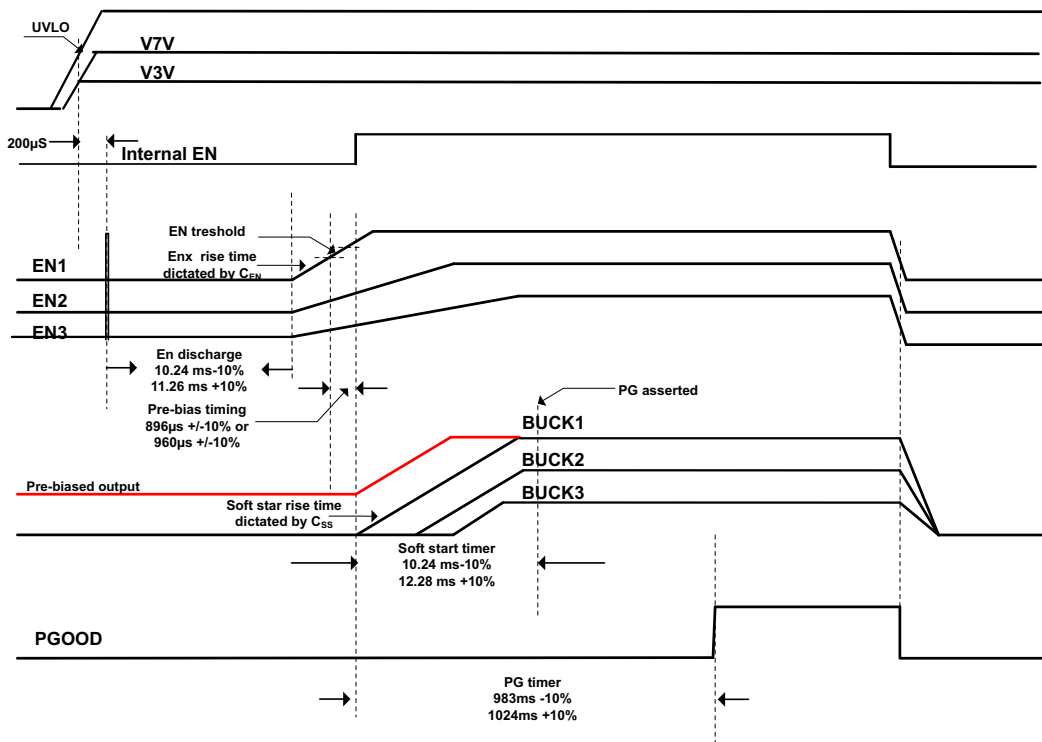

Figure 20. TPS65251-x Timing Diagram

7.3.6 Adjusting the Output Voltage

The output voltage is set with a resistor divider from the output node to the FB pin. TI recommends to use 1% tolerance or better divider resistors. To improve efficiency at light load, start with 40.2 kΩ for the R1 resistor and use Equation 3 to calculate R2.

$$R2 = R1 \times \left(\frac{0.8 \text{ V}}{V_O - 0.8 \text{ V}} \right) \quad (3)$$

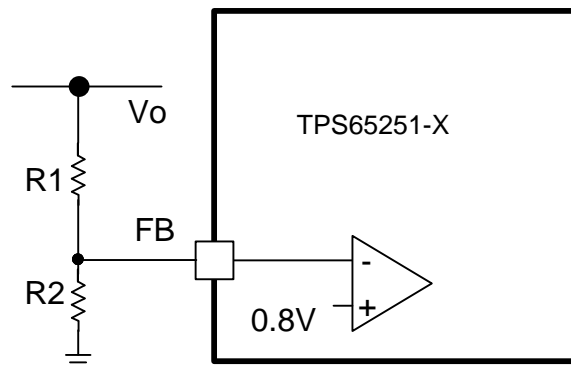

Figure 21. Voltage Divider Circuit

7.3.7 Input Capacitor

Use 10-μF X7R/X5R ceramic capacitors at the input of the converter inputs. Connect these capacitors as close as physically possible to the input pins of the converters.

Feature Description (continued)

7.3.8 Bootstrap Capacitor

The device has three integrated boot regulators and requires a small ceramic capacitor between the BST and LX pin to provide the gate drive voltage for the high-side MOSFET. The value of the ceramic capacitor should be 0.047 μ F. TI recommends a ceramic capacitor with an X7R or X5R grade dielectric because of the stable characteristics over temperature and voltage.

7.3.9 Error Amplifier

The device has a transconductance error amplifier. The frequency compensation network is connected between the COMP pin and ground.

7.3.10 Slope Compensation

The device has a built-in slope compensation ramp. The slope compensation can prevent subharmonic oscillations in peak current mode control.

7.3.11 Power Good

The PGOOD pin is an open-drain output. The PGOOD pin is pulled low when any buck converter is pulled below 85% of the nominal output voltage. TI recommends to use a pullup resistor from the PGOOD to the output of Buck 1. The PGOOD is pulled up when all three buck converters' outputs are more than 90% of its nominal output voltage.

The reset time of the PGOOD pin varies according to the part:

- TPS65251-1 is 1 s.
- TPS65251-2 is 32 ms.
- TPS65251-3 is 256 ms.

The polarity of the PGOOD pin is active high.

7.3.12 3.3-V and 6.5-V LDO Regulators

The following ceramic capacitor (X7R/X5R) should be connected as close as possible to the described pins:

- 10 μ F for V7V pin 28
- 3.3 μ F for V3V pin 29

7.3.13 Current Limit Protection

All converters operate in hiccup mode: After an overcurrent event lasting more than 10 ms is sensed in any of the converters, all the converters shut down for 10 ms, then the start-up sequencing is retried. If the overload has been removed, the converter ramps up and operates normally. If this is not the case, the converter senses another overcurrent event and shuts down again, repeating the cycle (hiccup) until the failure is cleared.

If an overload condition lasts for <10 ms, only the relevant affected converter goes into and out of under voltage and no global hiccup mode occurs. The converter is protected by the cycle-by-cycle current limit during that time.

7.3.14 Overvoltage Transient Protection (OVP)

The device incorporates an OVP circuit to minimize voltage overshoot. The OVP feature minimizes the output overshoot by implementing a circuit to compare the FB pin voltage to OVP threshold, which is 109% of the internal voltage reference. If the FB pin voltage is greater than the OVP threshold, the high-side MOSFET is disabled preventing current from flowing to the output and minimizing output overshoot. When the FB voltage drops below the lower OVP threshold, which is 107%, the high-side MOSFET is allowed to turn on the next clock cycle.

7.3.15 Thermal Shutdown

The device implements an internal thermal shutdown to protect itself if the junction temperature exceeds 160°C. The thermal shutdown forces the device to stop switching when the junction temperature exceeds thermal trip threshold. After the die temperature decreases below 140°C, the device reinitiates the power-up sequence. The thermal shutdown hysteresis is 20°C.

7.4 Device Functional Modes

7.4.1 Low-Power/Pulse Skipping Operation

When a synchronous buck converter operates at light load or standby conditions, the switching losses are the dominant source of power losses. Under these load conditions, TPS65251-x uses a pulse skipping modulation technique to reduce the switching losses by keeping the power transistors in the off-state for several switching cycles, while maintaining a regulated output voltage. Figure 22 shows the output voltage and load plus the inductor current.

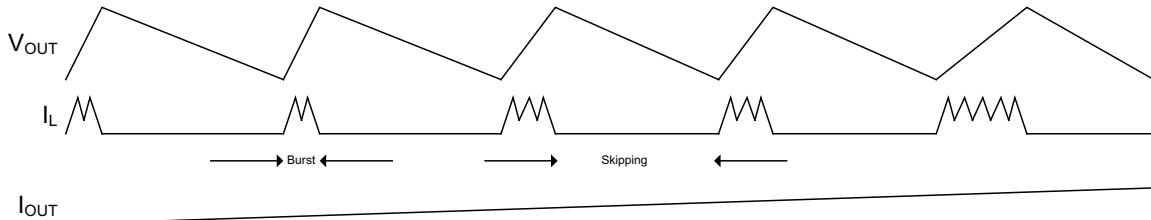

Figure 22. Low Power/Pulse Skipping

During the burst mode, the converter continuously charges up the output capacitor until the output voltage reaches a certain limit threshold. The operation of the converter in this interval is equivalent to the peak inductor current mode control. In each switch period, the main switch is turned on until the inductor current reaches the peak current limit threshold. As the load increases, the number of pulses increases to make sure that the output voltage stays within regulation limits. When the load is very light, the low-power controller has a zero crossing detector to allow the low-side MOSFET to operate even in light load conditions. The transistor is not disabled at light loads. A zero crossing detection circuit disables it when inductor current reverses. During the whole process, the body diode does not conduct, but is used as blocking diode only.

During the skipping interval, the upper and lower transistors are turned off and the converter stays in idle mode. The output capacitors are discharged by the load current until the moment when the output voltage drops to a low threshold.

The choice of output filter influences the performance of the low-power circuit. The maximum ripple during low-power mode can be calculated as:

$$V_{\text{OUT_RIPPLE}} = \frac{K_{\text{RIP}} T_{\text{S}}}{C_{\text{OUT}}}$$

where

- K_{RIP} is 1.4 for Buck 1.
- K_{RIP} is 0.7 for Buck 2 and Buck 3.

(4)

T_{S} can be calculated as:

$$T_{\text{S}} = \frac{0.35}{\left[\left(\frac{V_{\text{IN}} - V_{\text{OUT}}}{L} \right) \frac{V_{\text{OUT}}}{V_{\text{IN}}} \right]}$$

(5)

8 Application and Implementation

NOTE

Information in the following applications sections is not part of the TI component specification, and TI does not warrant its accuracy or completeness. TI's customers are responsible for determining suitability of components for their purposes. Customers should validate and test their design implementation to confirm system functionality.

8.1 Application Information

The device is triple synchronous step down dc/dc converter. It is typically used to convert a higher dc voltage to lower dc voltages with continuous available output current of 3 A/2 A/2 A. The following design procedure can be used to select component values for the TPS65251-x.

8.2 Typical Application

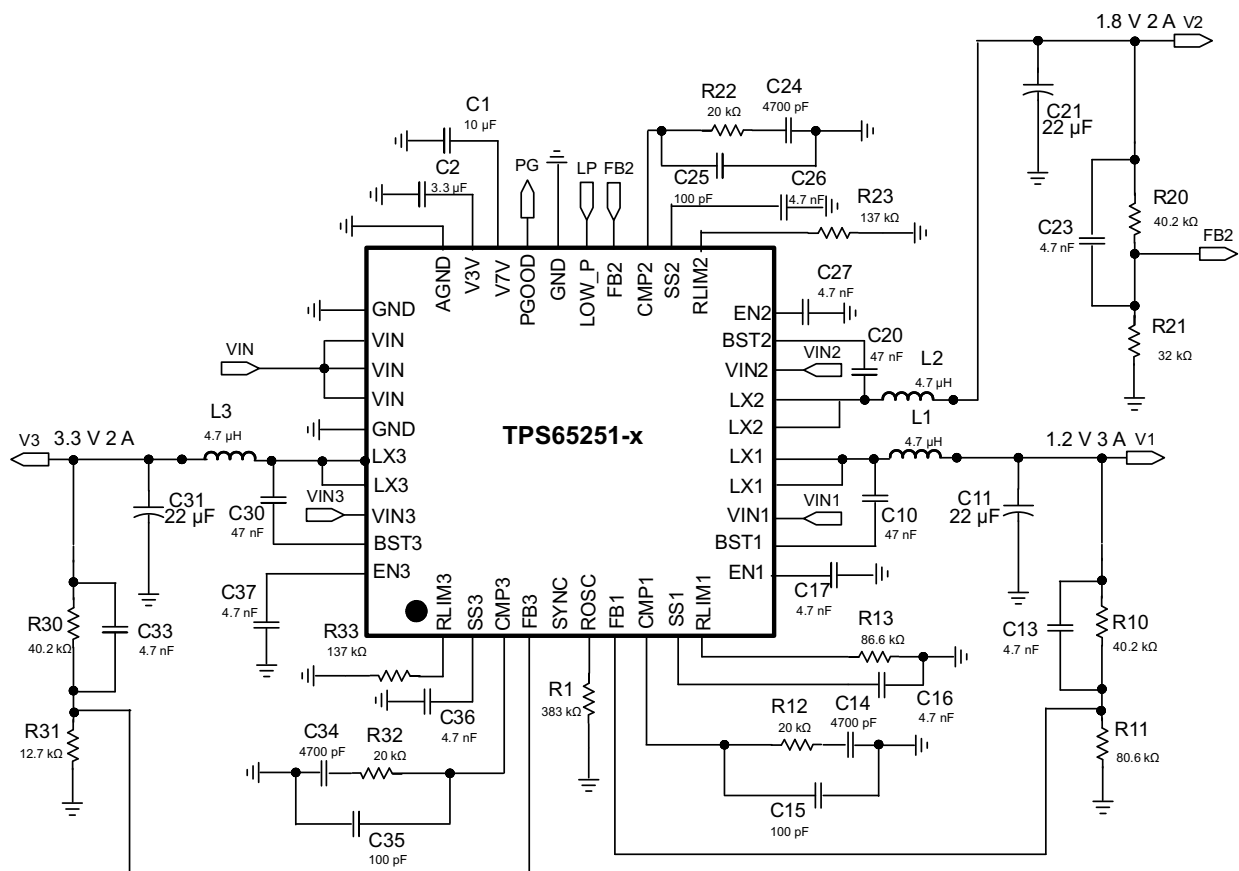

A. VIN pins require local decoupling capacitors.

Figure 23. Typical Application Circuit

8.2.1 Design Requirements

| DESIGN PARAMETERS | VALUE |
|---|-------------------------|
| Output voltage | 1.2 V |
| Transient response 0.5-A to 2-A load step | 120 mV |
| Maximum output current | 3 A |
| Input voltage | 12 V nom, 9.6 to 14.4 V |

| DESIGN PARAMETERS | VALUE |
|-----------------------|------------|
| Output voltage ripple | <30 mV p-p |
| Switching frequency | 500 kHz |

8.2.2 Detailed Design Procedure

8.2.2.1 Loop Compensation Circuit

A typical compensation circuit could be type II (R_c and C_c) to have a phase margin between 60° and 90° , or type III (R_c , C_c and C_{roll}) to improve the converter transient response. C_{roll} adds a high frequency pole to attenuate high-frequency noise when needed. It may also prevent noise coupling from other rails if there is possibility of cross coupling in between rails when layout is very compact.

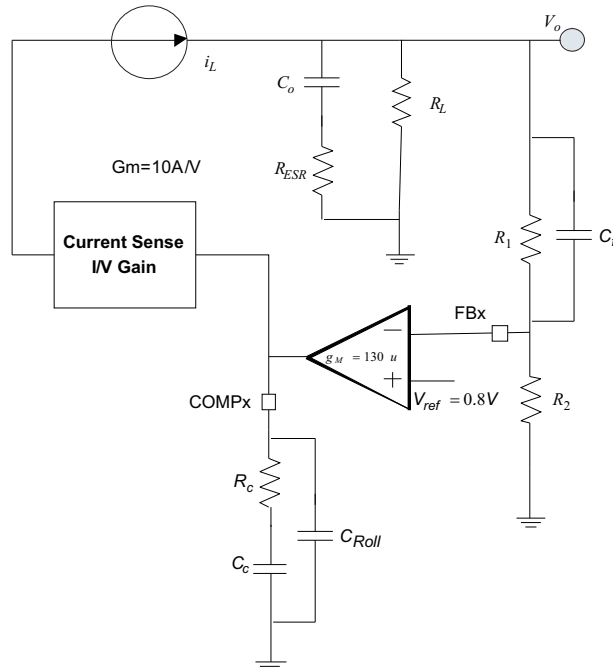

Figure 24. Loop Compensation

To calculate the external compensation components use [Table 1](#):

Table 1. Design Guideline for the Loop Compensation

| | TYPE II CIRCUIT | TYPE III CIRCUIT |
|---|--|---|
| Select switching frequency that is appropriate for application depending on L, C sizes, output ripple, EMI concerns and etc. Switching frequencies between 500 kHz and 1 MHz give best trade off between performance and cost. When using smaller L and Cs, switching frequency can be increased. To optimize efficiency, switching frequency can be lowered. | | Type III circuit recommended for switching frequencies higher than 500 kHz. |
| Select cross over frequency (f_c) to be less than 1/5 to 1/10 of switching frequency. | Suggested $f_c = f_s/10$ | Suggested $f_c = f_s/10$ |
| Set and calculate R_c . | $R_c = \frac{2\pi \times f_c \times V_o \times C_o}{g_m \times V_{ref} \times g_{m_{ps}}} \quad (6)$ | $R_c = \frac{2\pi \times f_c \times C_o}{g_m \times g_{m_{ps}}} \quad (7)$ |
| Calculate C_c by placing a compensation zero at or before the converter dominant pole $f_p = \frac{1}{C_o \times R_L \times 2\pi} \quad (8)$ | $C_c = \frac{R_L \times C_o}{R_c} \quad (9)$ | $C_c = \frac{R_L \times C_o}{R_c} \quad (10)$ |

Table 1. Design Guideline for the Loop Compensation (continued)

| | TYPE II CIRCUIT | TYPE III CIRCUIT |
|--|--|---|
| Add C_{Roll} if needed to remove large signal coupling to high impedance COMP node. Make sure that $f_{p_{Roll}} = \frac{1}{2 \times \pi \times R_C \times C_{Roll}} \quad (11)$ is at least twice the cross over frequency. | $C_{Roll} = \frac{Re_{sr} \times C_O}{R_C} \quad (12)$ | $C_{Roll} = \frac{Re_{sr} \times C_O}{R_C} \quad (13)$ |
| Calculate C_{ff} compensation zero at low frequency to boost the phase margin at the crossover frequency. Make sure that the zero frequency ($f_{z_{ff}}$ is smaller than soft-start equivalent frequency ($1/T_{ss}$). | NA | $C_{ff} = \frac{1}{2 \times \pi \times f_{z_{ff}} \times R_1} \quad (14)$ |

8.2.2.2 Selecting the Switching Frequency

The first step is to decide on a switching frequency for the regulator. Typically, you will want to choose the highest switching frequency possible since this will produce the smallest solution size. The high switching frequency allows for lower valued inductors and smaller output capacitors compared to a power supply that switches at a lower frequency. However, the highest switching frequency causes extra switching losses, which hurt the converter's performance. The converter is capable of running from 300 kHz to 2.2 MHz. Unless a small solution size is an ultimate goal, a moderate switching frequency of 500 kHz is selected to achieve both a small solution size and a high efficiency operation. Using [Figure 19](#), R_1 is determined to be 383 k Ω .

8.2.2.3 Output Inductor Selection

To calculate the value of the output inductor, use [Equation 15](#). $KIND$ is a coefficient that represents the amount of inductor ripple current relative to the maximum output current. In general, $KIND$ is normally from 0.1 to 0.3 for the majority of applications.

For this design example, use $KIND = 0.2$ and the inductor value is calculated to be 3.6 μ H. For this design, a nearest standard value was chosen: 4.7 μ H. For the output filter inductor, it is important that the RMS current and saturation current ratings not be exceeded. The RMS and peak inductor current can be found from [Equation 16](#) and [Equation 17](#).

$$L_o = \frac{V_{in} - V_{out}}{I_o \times K_{ind}} \times \frac{V_{out}}{V_{in} \times f_{sw}} \quad (15)$$

$$I_{ripple} = \frac{V_{in} - V_{out}}{L_o} \times \frac{V_{out}}{V_{in} \times f_{sw}} \quad (16)$$

$$I_{Lrms} = \sqrt{I_o^2 + \frac{1}{12} \times \left(\frac{V_o \times (V_{inmax} - V_o)}{V_{inmax} \times L_o \times f_{sw}} \right)^2} \quad (17)$$

$$I_{Lpeak} = I_{out} + \frac{I_{ripple}}{2} \quad (18)$$

8.2.2.4 Output Capacitor

There are two primary considerations for selecting the value of the output capacitor. The output capacitors are selected to meet load transient and output ripple's requirements.

[Equation 19](#) gives the minimum output capacitance to meet the transient specification. For this example, $L_o = 4.7 \mu$ H, $\Delta I_{OUT} = 1.5 \text{ A} - 0.75 \text{ A} = 0.75 \text{ A}$ and $\Delta V_{OUT} = 120 \text{ mV}$. Using these numbers gives a minimum capacitance of 18 μ F. A standard 22- μ F ceramic capacitor is chose in the design.

$$C_o > \frac{\Delta I_{OUT}^2 \times L_o}{V_{out} \times \Delta V_{out}} \quad (19)$$

Equation 20 calculates the minimum output capacitance needed to meet the output voltage ripple specification. Where f_{sw} is the switching frequency, V_{RIPPLE} is the maximum allowable output voltage ripple, and I_{RIPPLE} is the inductor ripple current. In this case, the maximum output voltage ripple is 30 mV. From **Equation 16**, the output current ripple is 0.46 A. From **Equation 20**, the minimum output capacitance meeting the output voltage ripple requirement is 1.74 μ F.

$$C_o > \frac{1}{8 \times f_{sw}} \times \frac{1}{\frac{V_{ripple}}{I_{ripple}}} \quad (20)$$

Additional capacitance de-rating for aging, temperature and DC bias should influence this minimum value. For this example, one 22- μ F, 6.3-V X7R ceramic capacitor with 3 m Ω of ESR will be used.

8.2.2.5 Input Capacitor

A minimum 10- μ F X7R/X5R ceramic input capacitor is recommended to be added between VIN and GND. These capacitors should be connected as close as physically possible to the input pins of the converters as they handle the RMS ripple current shown in **Equation 21**. For this example, $I_{OUT} = 3$ A, $V_{OUT} = 1.2$ V, $V_{INmin} = 9.6$ V, from **Equation 21**, the input capacitors must support a ripple current of 0.99 A RMS.

$$I_{cirms} = I_{out} \times \sqrt{\frac{V_{out}}{V_{inmin}} \times \frac{(V_{inmin} - V_{out})}{V_{inmin}}} \quad (21)$$

The input capacitance value determines the input ripple voltage of the regulator. The input voltage ripple can be calculated using **Equation 22**. Using the design example values, $I_{OUTmax} = 3$ A, $C_{IN} = 10$ μ F, $f_{SW} = 500$ kHz, yields an input voltage ripple of 150 mV.

$$\Delta V_{in} = \frac{I_{outmax} \times 0.25}{C_{in} \times f_{sw}} \quad (22)$$

8.2.2.6 Soft-Start Capacitor

The soft-start capacitor determines the minimum amount of time it will take for the output voltage to reach its nominal programmed value during power-up. This is useful if the output capacitance is very large and would require large amounts of current to quickly charge the capacitor to the output voltage level.

The soft-start capacitor value can be calculated using **Equation 23**. In this example, the converter's soft-start time is 0.8 ms. In TPS65251-x, I_{ss} is 5 μ A and V_{ref} is 0.8 V. From **Equation 23**, the soft-start capacitance is 5 nF. A standard 4.7-nF ceramic capacitor is chosen in this design. In this example, C16 is 4.7 nF

$$C_{ss}(nF) = \frac{T_{ss}(ms) \times I_{ss}(\mu A)}{V_{ref}(V)} \quad (23)$$

8.2.2.7 Bootstrap Capacitor Selection

A 0.047- μ F ceramic capacitor must be connected between the BST to LX pin for proper operation. It is recommended to use a ceramic capacitor with X5R or better grade dielectric. The capacitor should have 10-V or higher voltage rating.

8.2.2.8 Adjustable Current Limiting Resistor Selection

The converter uses the voltage drop on the high-side MOSFET to measure the inductor current. The overcurrent protection threshold can be optimized by changing the trip resistor. **Figure 6** governs the threshold of overcurrent protection for Buck 1. When selecting a resistor, do not exceed the graph limits. In this example, the over current threshold is 3.2 A. In order to prevent a premature limit trip, the minimum line is used and the resistor is 86.6 k Ω .

When setting high-side current limit to large current values, ensure that the additional load immediately prior to an overcurrent condition will not cause the switching node voltage to exceed 20 V. Additionally, ensure during worst case operation, with all bucks loaded immediately prior to current limit, the maximum virtual junction temperature of the device does not exceed 125°C.

8.2.2.9 Output Voltage and Feedback Resistors Selection

For the example design, 40.2 kΩ was selected for R10. Vout is 1.2 V, Vref = 0.8 V. Using Equation 24, R11 is calculated as 80.4 kΩ. A standard 80.6-kΩ resistor is chose in this design.

$$R11 = \frac{V_{out} - V_{ref}}{V_{ref}} \times R10 \tag{24}$$

8.2.2.10 Compensation

A type-II compensation circuit is adequate for the converter to have a phase margin between 60 and 90 degrees. The following equations show the procedure of designing a peak current mode control dc/dc converter.

The compensation design takes the following steps:

1. Set up the anticipated cross-over frequency. In this example, the anticipated cross-over frequency (fc) is 65 kHz. The power stage gain (gm_{PS}) is 10 A/V and the GM amplifier gain (g_M) is 130 μA/V.

$$R12 = \frac{2\pi \times f_c \times V_o \times C_o}{g_M \times V_{ref} \times g_{m_{ps}}} \tag{25}$$

2. Place compensation zero at low frequency to boost the phase margin at the crossover frequency. From the procedures above, the compensation network includes a 20-kΩ resistor (R12) and a 4700-pF capacitor (C1).
3. An additional pole can be added to attenuate high frequency noise.

From the procedures above, the compensation network includes a 20-kΩ resistor (R12) and a 4700-pF capacitor (C14).

8.2.2.11 3.3-V and 6.5-V LDO Regulators

The following ceramic capacitor (X7R/X5R) should be connected as close as possible to the described pins:

- 10 μF for V7V pin 28
- 3.3 μF to 10 μF for V3V pin 29

8.2.3 Application Curves

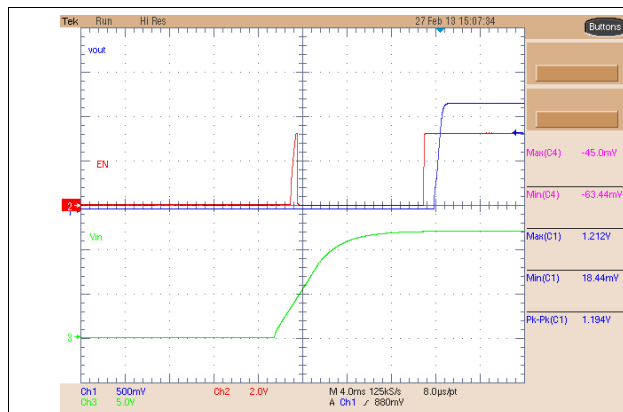

Figure 25. Buck 1 Start-Up (Ch3 = V_{IN})

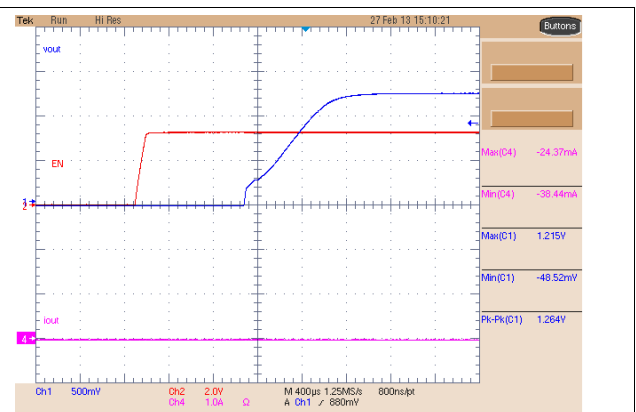

Figure 26. Buck 1 Soft-Start

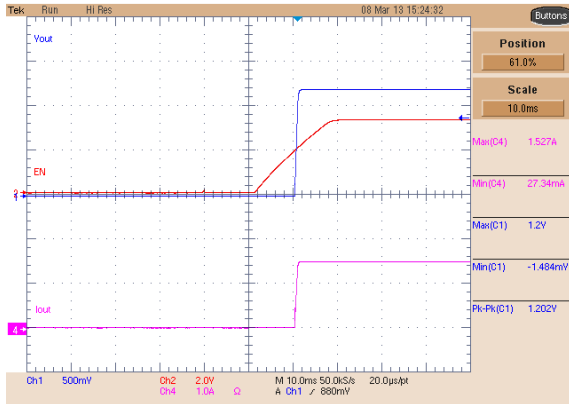

Figure 27. Buck 1 Start-Up 1.5-A Resistive

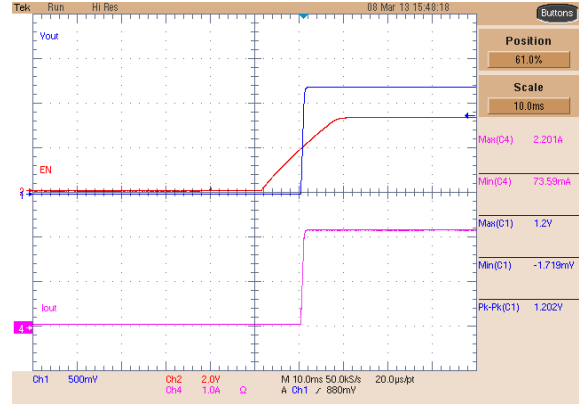

Figure 28. Buck 1 Soft-Start 2-A Load

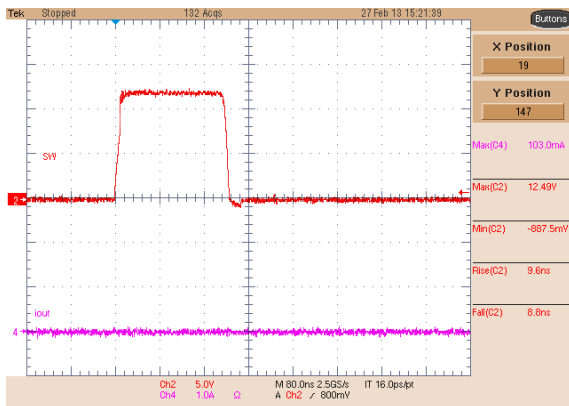

Figure 29. Buck 1 Switching Node, No Load

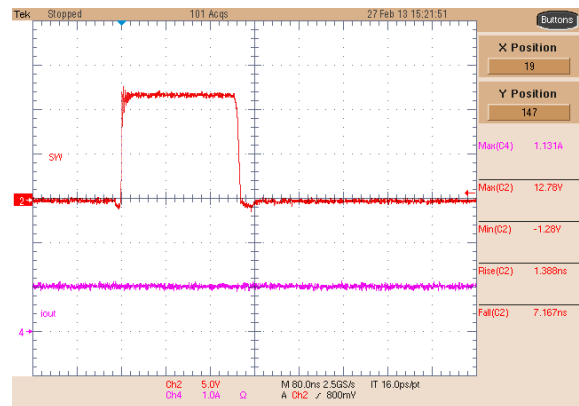

Figure 30. Buck 1 Switching Node, 1-A Load

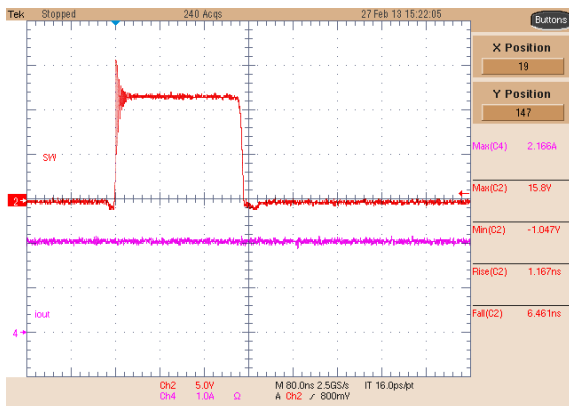

Figure 31. Buck 1 Switching Node, 2-A Load

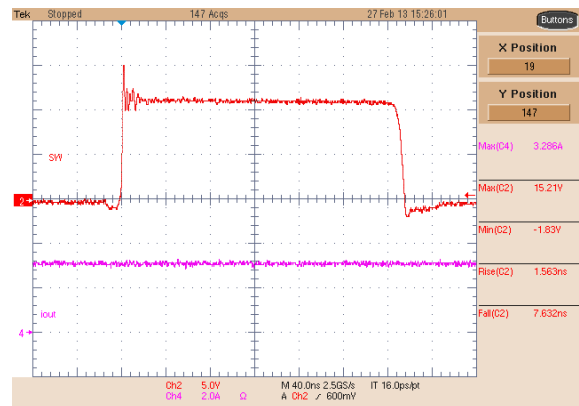

Figure 32. Buck 1 Switching Node, 3-A Load

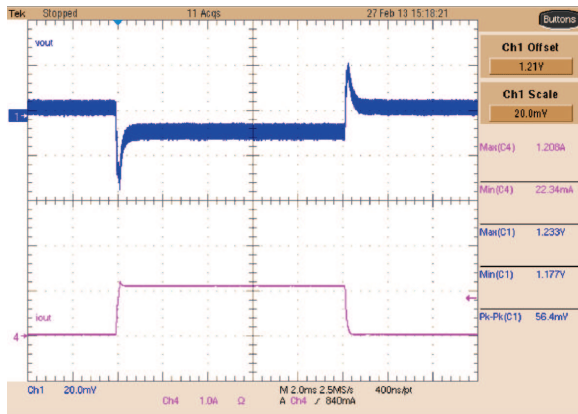

Figure 33. Buck 1 Dynamic Response, 0- to 1-A Step

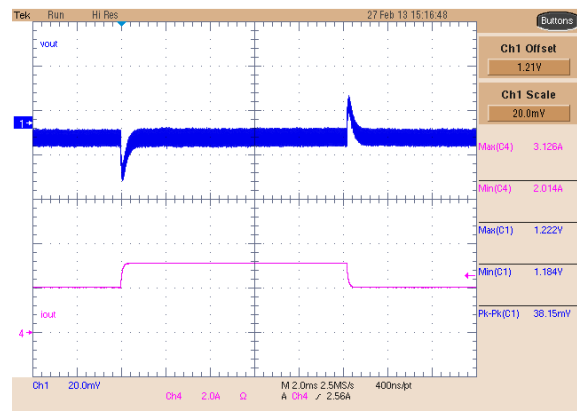

Figure 34. Buck 1 Dynamic Response, 2-A to 3-A Step

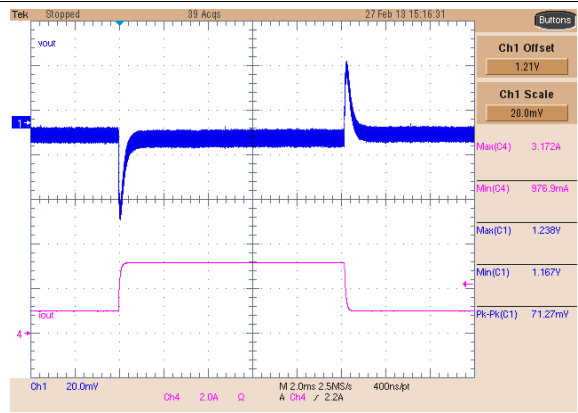

Figure 35. Buck 1 Dynamic Response, 1-A to 3-A Step

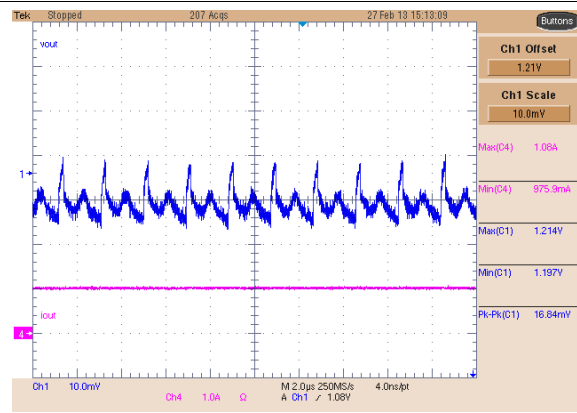

Figure 36. Buck 1 Ripple, 1-A Load

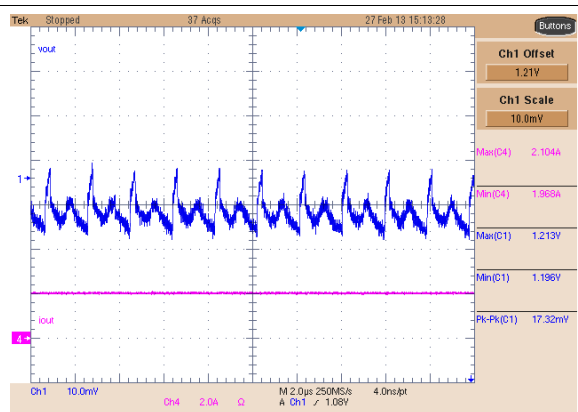

Figure 37. Buck 1 Ripple, 2-A Load

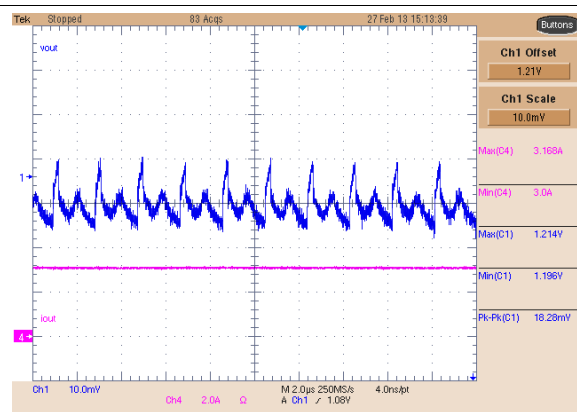
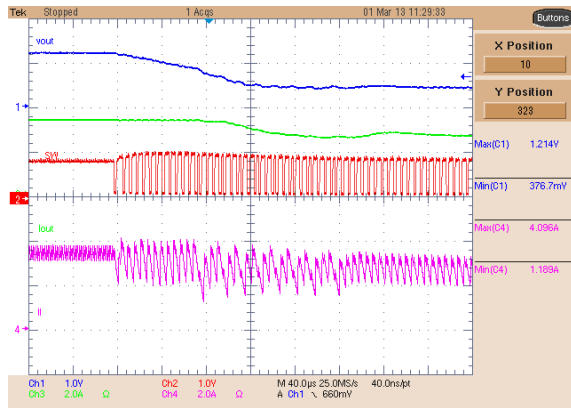
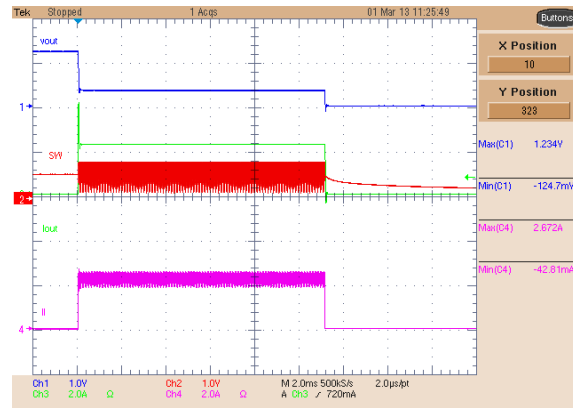

Figure 38. Buck 1 Ripple, 3-A Load



Ch1 = V_{OUT} Ch2 = COMP1 Ch3 = I_{OUT}
Ch4 = Inductor

Figure 39. Buck 1 Current Limit Operation With Slow Rising Output Current, Trip at 4 A



Ch1 = V_{OUT} Ch2 = COMP1 Ch3 = I_{OUT}
Ch4 = Inductor

Figure 40. Buck 1 Current Limit Operation, Hiccup

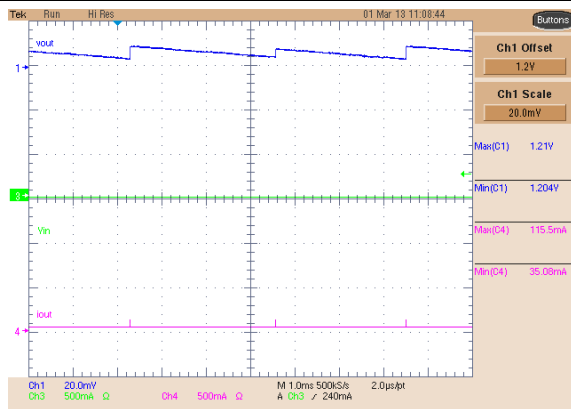

Figure 41. Buck 1 Low-Power Output, No Load

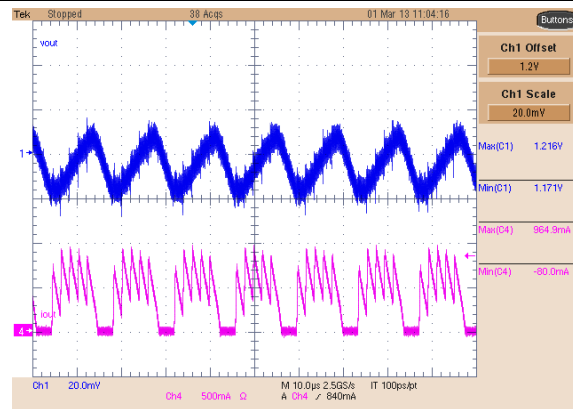
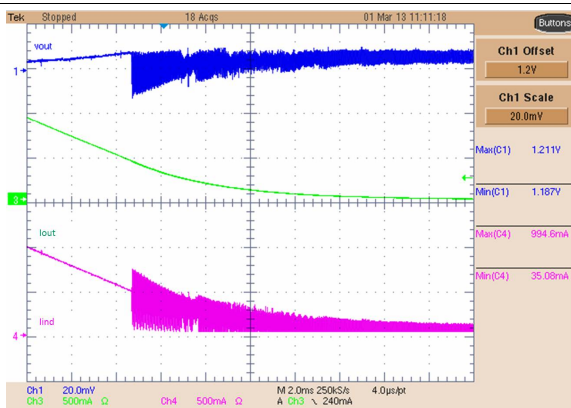
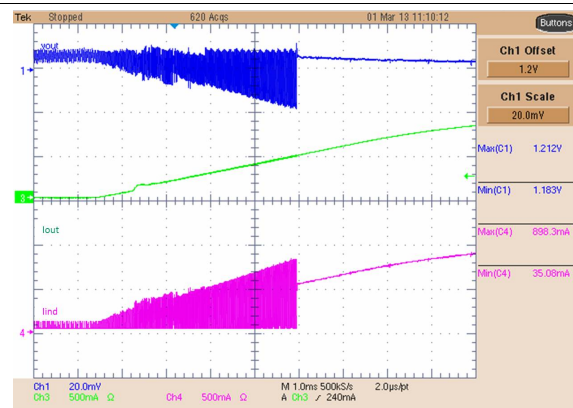

Figure 42. Buck 1 Low-Power Operation



Ch1 = V_{OUT} Ch3 = I_{OUT} Ch4 = Inductor

Figure 43. Buck 1 PFM to PWM Transition



Ch1 = V_{OUT} Ch3 = I_{OUT} Ch4 = Inductor

Figure 44. Buck 1 PWM to PFM Transition

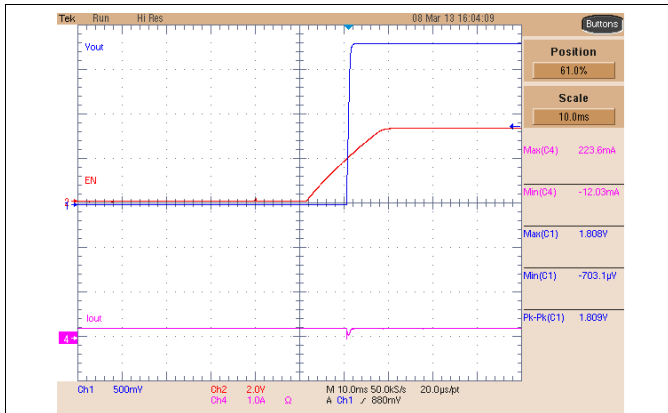

Ch3 = V_{IN}

Figure 45. Buck 2 Start-Up, No Load

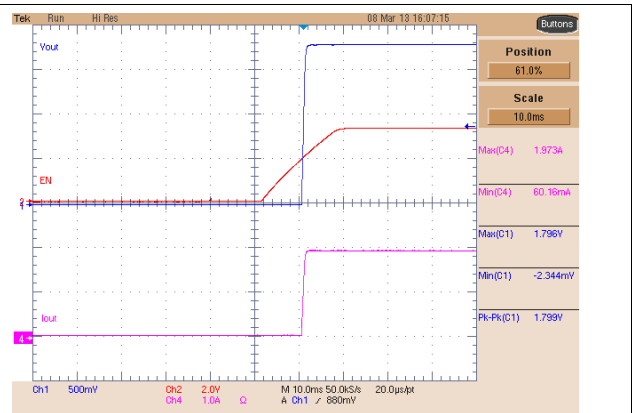

Figure 46. Buck 2 Start-Up, 2-A Load

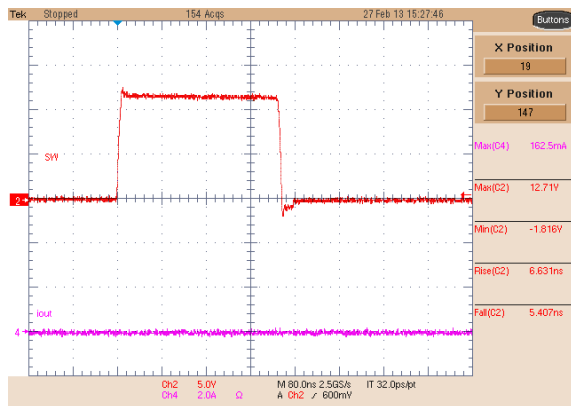

Figure 47. Buck 2 Switching Node, No Load

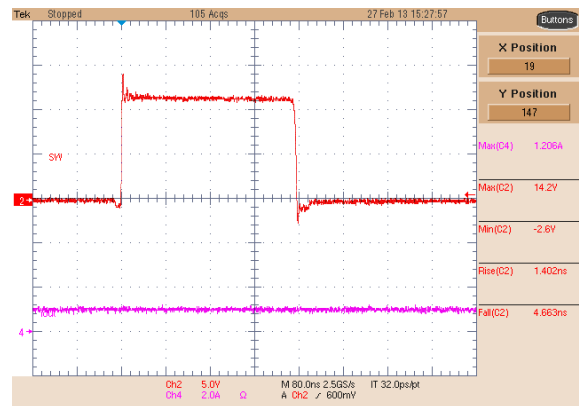

Figure 48. Buck 2 Switching Node, 1-A Load

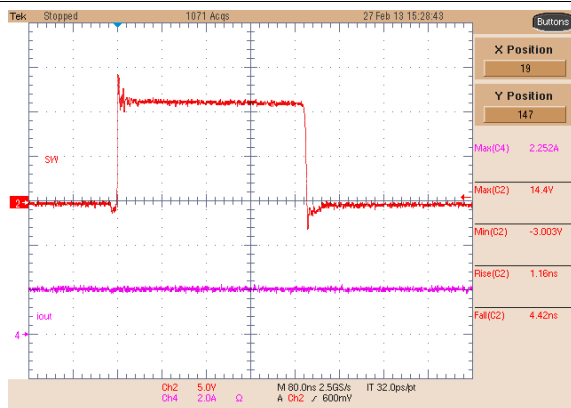

Figure 49. Buck 2 Switching Node, 2-A Load

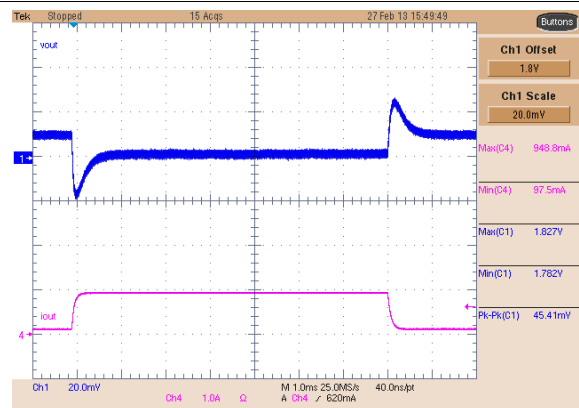

Figure 50. Buck 2 Dynamic Response, 0-A to 1-A Step

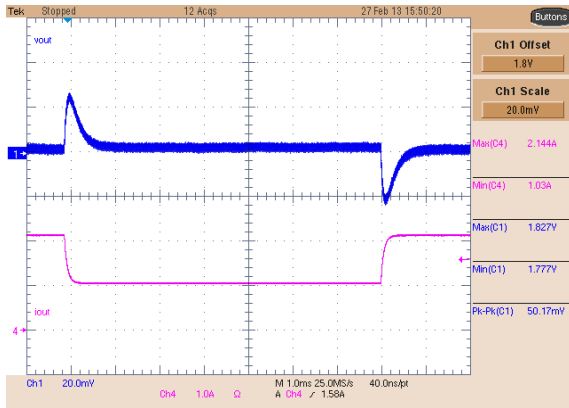

Figure 51. Buck 2 Dynamic Response, 1-A to 2-A Step

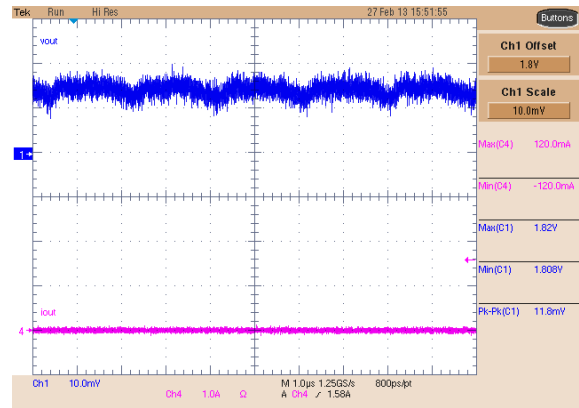

Figure 52. Buck 2 Ripple, No Load

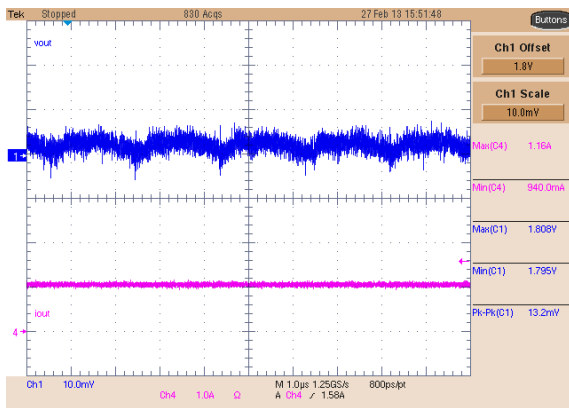

Figure 53. Buck 2 Ripple, 1-A Load

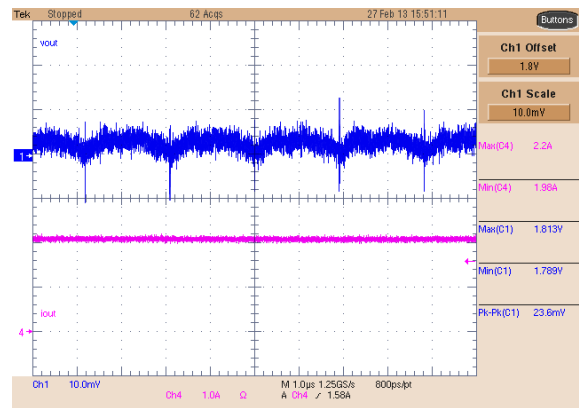

Figure 54. Buck 2 Ripple, 3-A Load

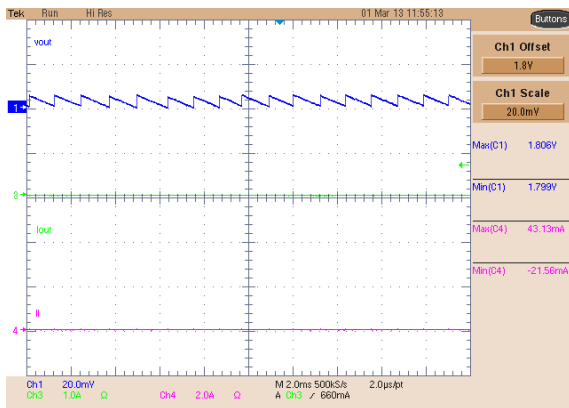
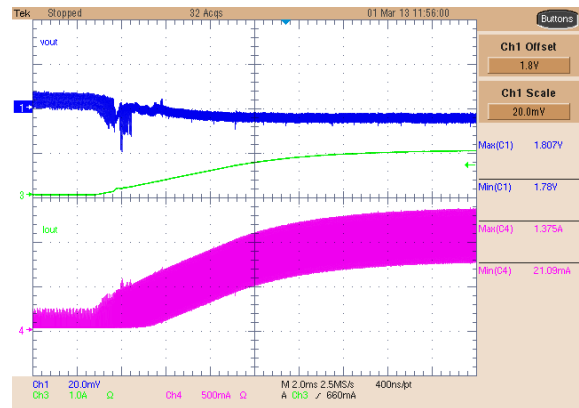
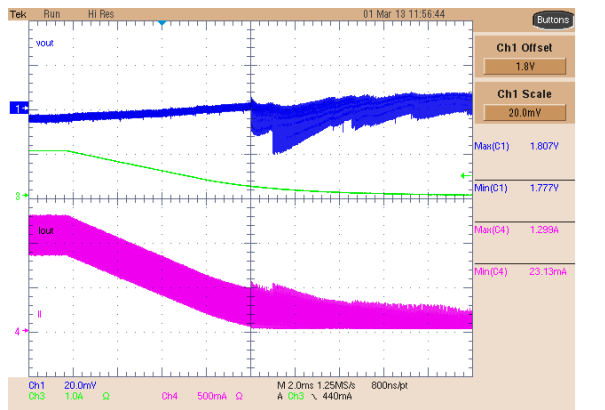

Figure 55. Buck 2 Low-Power Output, No Load



Ch1 = V_{OUT} Ch3 = I_{OUT} Ch4 = Inductor

Figure 56. Buck 2 PFM to PWM Transition



Ch1 = V_{OUT} Ch3 = I_{OUT} Ch4 = Inductor

Figure 57. Buck 2 PWM to PFM Transition

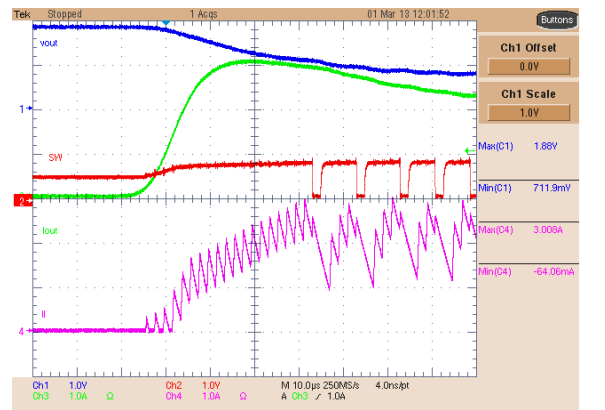

Ch1 = V_{OUT} Ch2 = COMP1
 Ch3 = I_{OUT} Ch4 = Inductor

Figure 58. Buck 2 Current Limit Operation

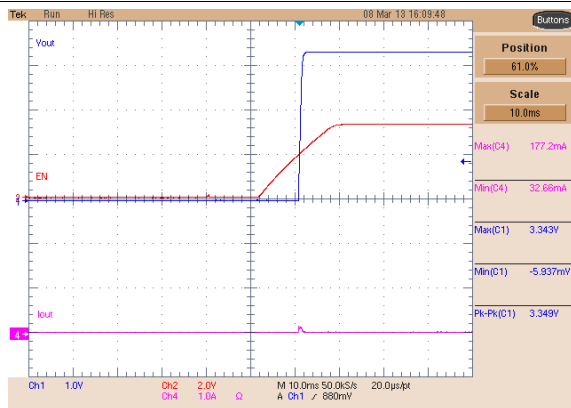

Ch3 = V_{IN}

Figure 59. Buck 3 Start-Up

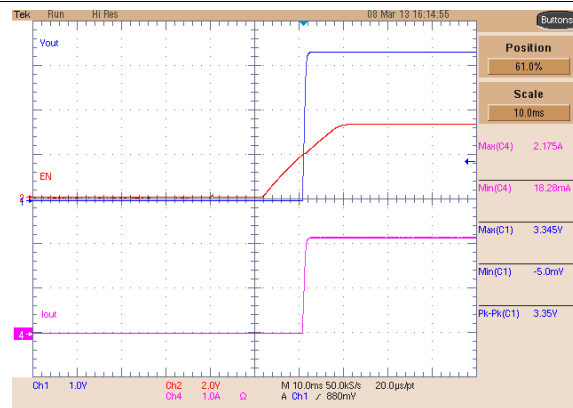

Figure 60. Buck 3 Soft-Start

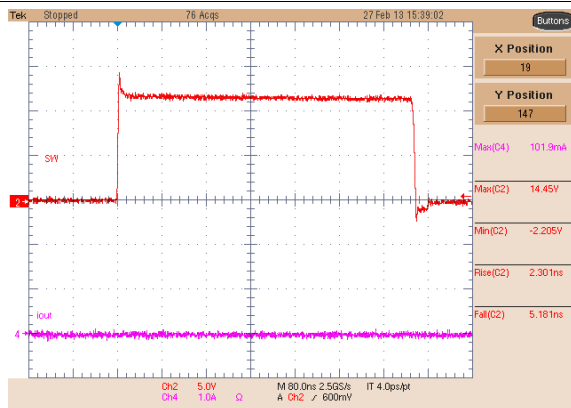

Figure 61. Buck 3 Switching Node, No Load

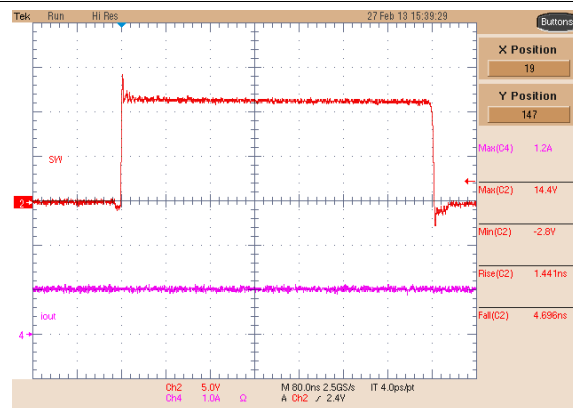

Figure 62. Buck 3 Switching Node, 1-A Load

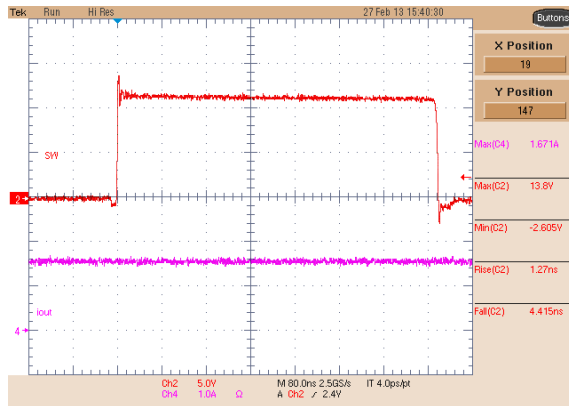

Figure 63. Buck 3 Switching Node, 1.5-A Load

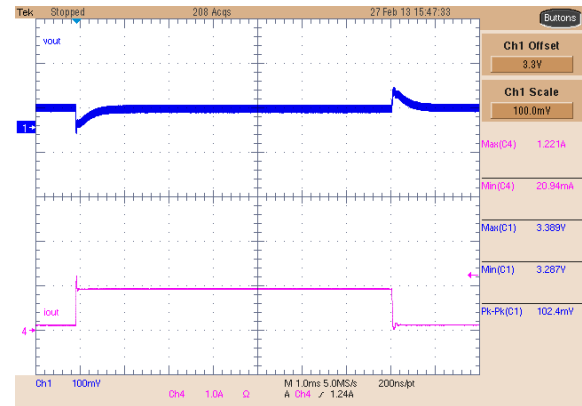

Figure 64. Buck 3 Dynamic Response, 0-A to 1-A Step

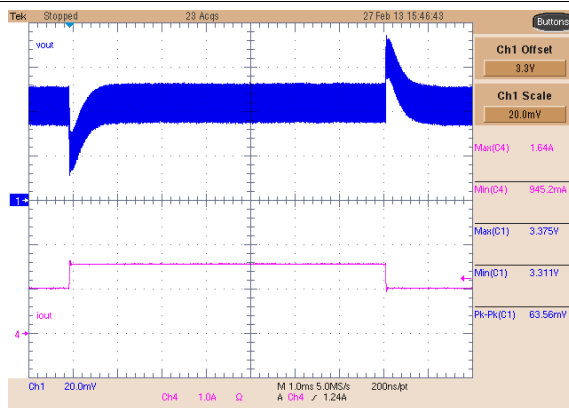

Figure 65. Buck 3 Dynamic Response, 1-A to 1.5-A Step

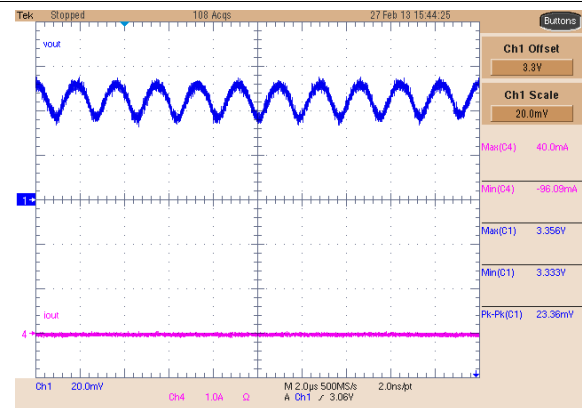

Figure 66. Buck 3 Ripple, No Load

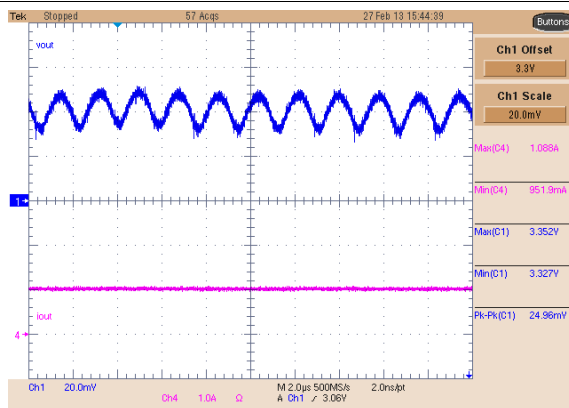

Figure 67. Buck 3 Ripple, 1-A Load

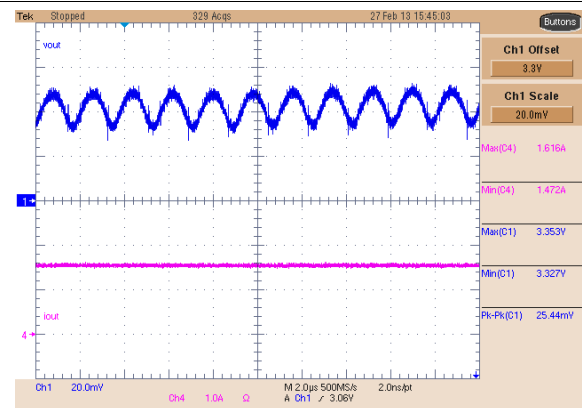

Figure 68. Buck 3 Ripple, 3-A Load

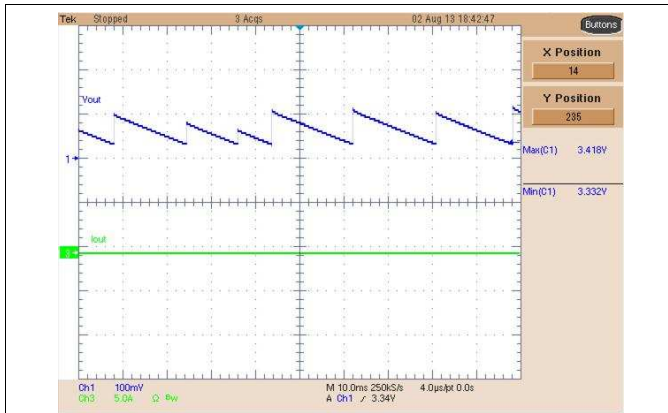
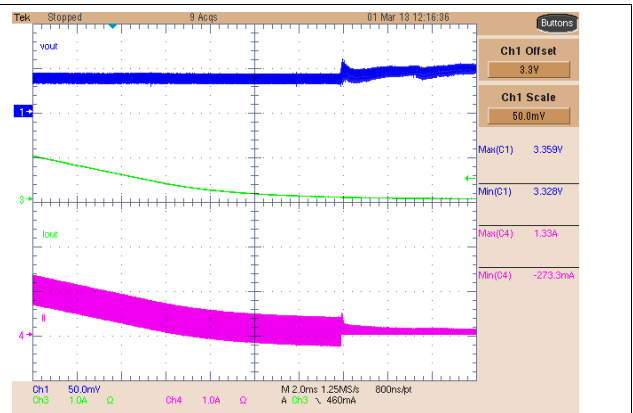
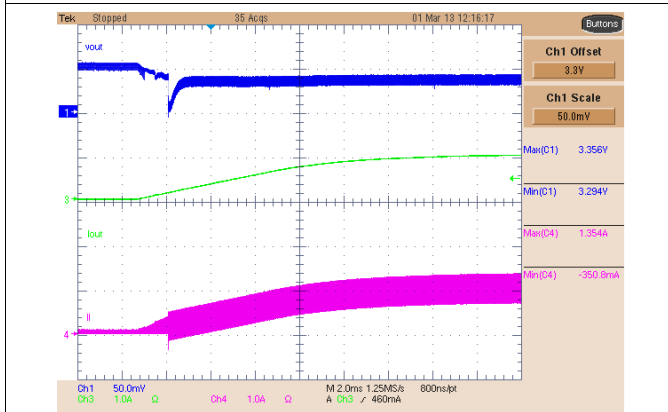

Figure 69. Buck 3 Low-Power Output, No Load



Ch1 = V_{OUT} Ch3 = I_{OUT} Ch4 = Inductor

Figure 70. Buck 3 PFM to PWM Transition



Ch1 = V_{OUT} Ch3 = I_{OUT} Ch4 = Inductor

Figure 71. Buck 3 PWM to PFM Transition

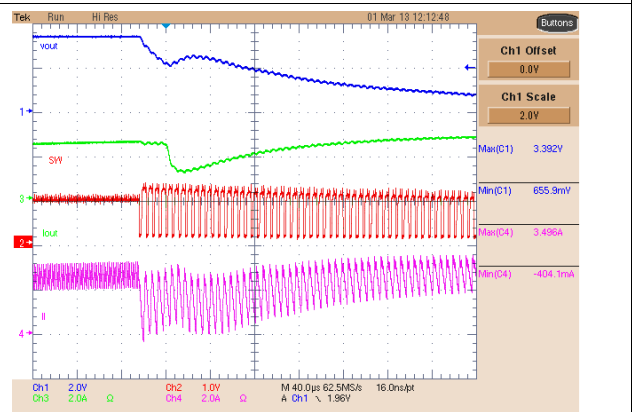

Ch1 = V_{OUT} Ch2 = COMP1 Ch3 = I_{OUT}
Ch4 = Inductor

Figure 72. Buck 3 Current Limit Operation

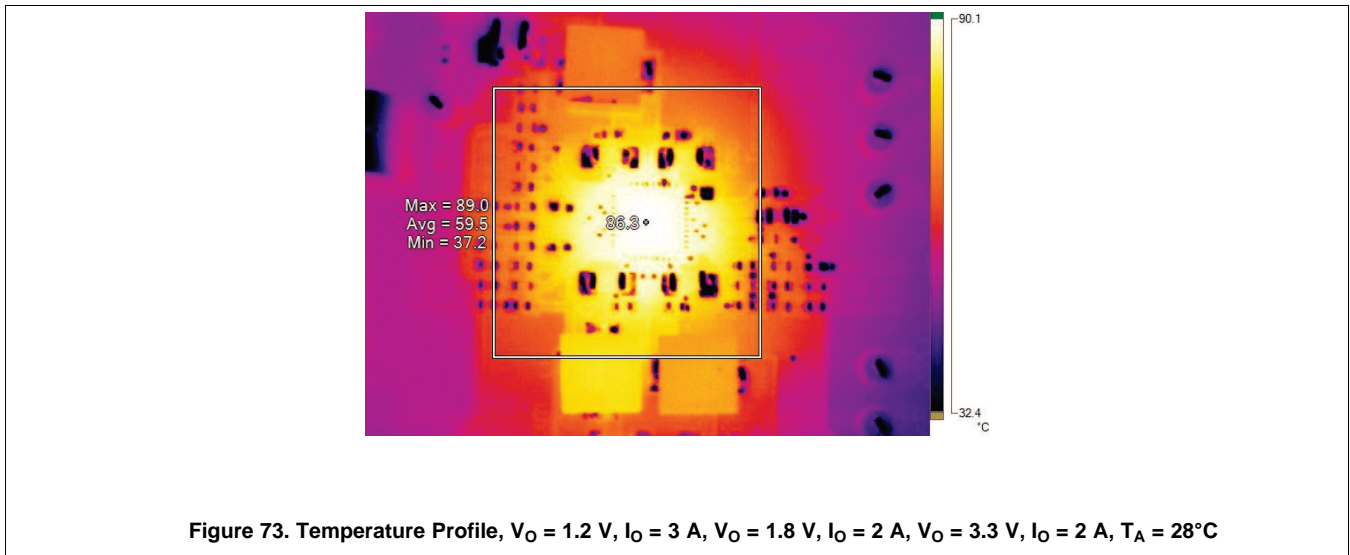

Figure 73. Temperature Profile, $V_O = 1.2\text{ V}$, $I_O = 3\text{ A}$, $V_O = 1.8\text{ V}$, $I_O = 2\text{ A}$, $V_O = 3.3\text{ V}$, $I_O = 2\text{ A}$, $T_A = 28^\circ\text{C}$

9 Power Supply Recommendations

The device is designed to operate from an input voltage supply range between 4.5 V and 18 V. This input power supply should be well regulated. If the input supply is located more than a few inches from the TPS65251-x converter, additional bulk capacitance may be required in addition to the ceramic bypass capacitors. An electrolytic capacitor with a value of 47 μ F is a typical choice.

10 Layout

10.1 Layout Guidelines

Layout is a critical portion of PMIC designs.

- Place VOUT, and LX on the top layer and an inner power plane for VIN.
- Fit also on the top layer connections for the remaining pins of the PMIC and a large top side area filled with ground.
- The top layer ground area should be connected to the internal ground layer(s) using vias at the input bypass capacitor, the output filter capacitor and directly under the TPS65251-x device to provide a thermal path from the Powerpad land to ground.
- The AGND pin should be tied directly to the power pad under the IC and the power pad.
- For operation at full rated load, the top side ground area together with the internal ground plane, must provide adequate heat dissipating area.
- There are several signals paths that conduct fast changing currents or voltages that can interact with stray inductance or parasitic capacitance to generate noise or degrade the power supplies performance. To help eliminate these problems, the VIN pin should be bypassed to ground with a low ESR ceramic bypass capacitor with X5R or X7R dielectric. Care should be taken to minimize the loop area formed by the bypass capacitor connections, the VIN pins, and the ground connections. Since the LX connection is the switching node, the output inductor should be located close to the LX pins, and the area of the PCB conductor minimized to prevent excessive capacitive coupling.
- The output filter capacitor ground should use the same power ground trace as the VIN input bypass capacitor. Try to minimize this conductor length while maintaining adequate width.
- The compensation should be as close as possible to the COMP pins. The COMP and OSC pins are sensitive to noise so the components associated to these pins should be located as close as possible to the IC and routed with minimal lengths of trace.

10.2 Layout Example

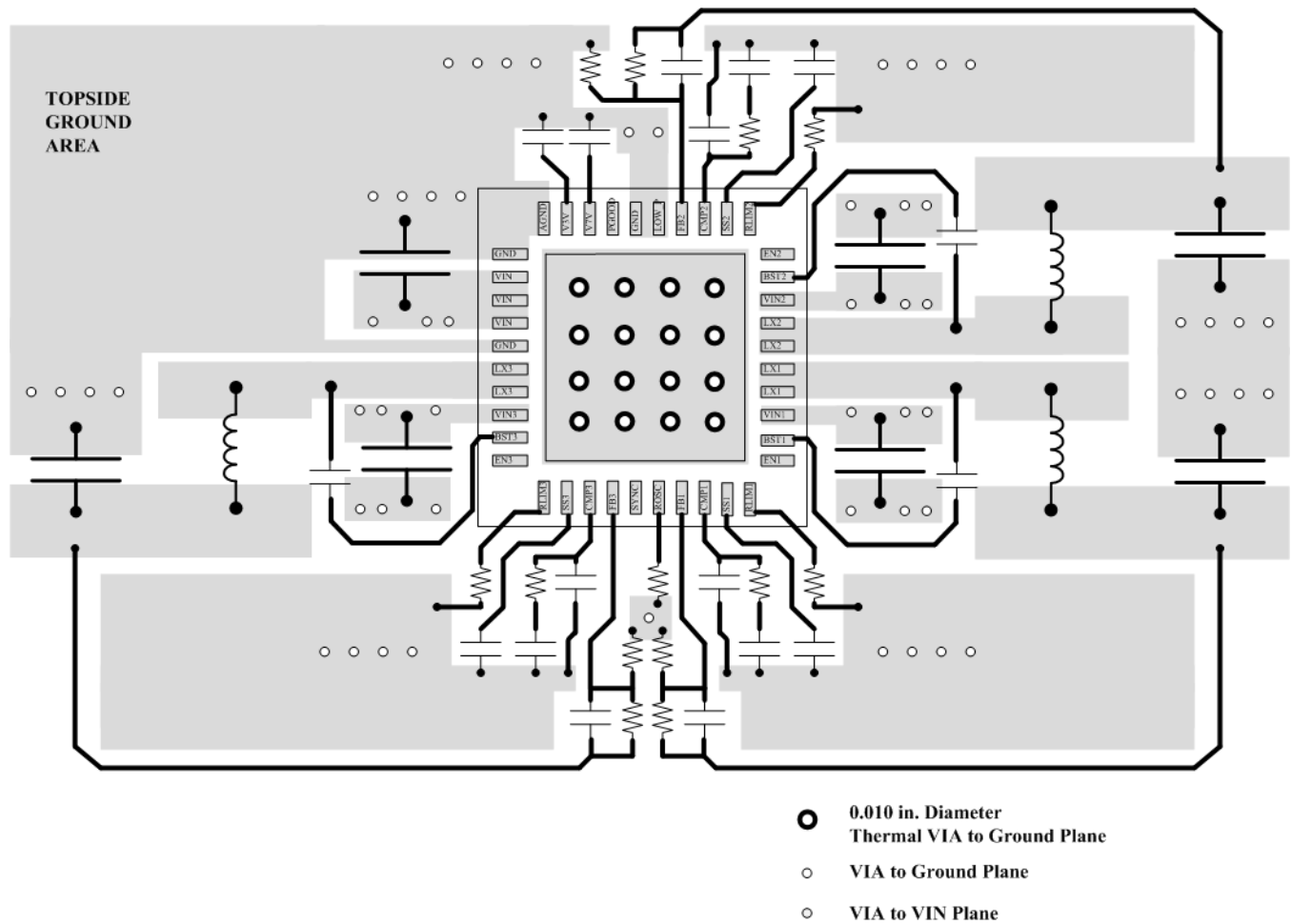

Figure 74. Layout Schematic

11 Device and Documentation Support

11.1 Related Links

The table below lists quick access links. Categories include technical documents, support and community resources, tools and software, and quick access to sample or buy.

Table 2. Related Links

| PARTS | PRODUCT FOLDER | SAMPLE & BUY | TECHNICAL DOCUMENTS | TOOLS & SOFTWARE | SUPPORT & COMMUNITY |
|------------|----------------------------|----------------------------|----------------------------|----------------------------|----------------------------|
| TPS65251-1 | Click here | Click here | Click here | Click here | Click here |
| TPS65251-2 | Click here | Click here | Click here | Click here | Click here |
| TPS65251-3 | Click here | Click here | Click here | Click here | Click here |

11.2 Trademarks

Blu-ray is a trademark of Blu-ray Disc Association.
All other trademarks are the property of their respective owners.

11.3 Electrostatic Discharge Caution



This integrated circuit can be damaged by ESD. Texas Instruments recommends that all integrated circuits be handled with appropriate precautions. Failure to observe proper handling and installation procedures can cause damage.

ESD damage can range from subtle performance degradation to complete device failure. Precision integrated circuits may be more susceptible to damage because very small parametric changes could cause the device not to meet its published specifications.

11.4 Glossary

[SLYZ022](#) — *TI Glossary*.

This glossary lists and explains terms, acronyms, and definitions.

12 Mechanical, Packaging, and Orderable Information

The following pages include mechanical, packaging, and orderable information. This information is the most current data available for the designated devices. This data is subject to change without notice and revision of this document. For browser-based versions of this data sheet, refer to the left-hand navigation.

PACKAGING INFORMATION

| Orderable Device | Status (1) | Package Type | Package Drawing | Pins | Package Qty | Eco Plan (2) | Lead/Ball Finish (6) | MSL Peak Temp (3) | Op Temp (°C) | Device Marking (4/5) | Samples |
|------------------|---------------|--------------|-----------------|------|-------------|-------------------------|-------------------------|----------------------|--------------|-------------------------|-------------------------|
| TPS65251-1RHAR | ACTIVE | VQFN | RHA | 40 | 2500 | Green (RoHS & no Sb/Br) | CU NIPDAU | Level-3-260C-168 HR | -40 to 125 | TPS 65251-1 | Samples |
| TPS65251-1RHAT | ACTIVE | VQFN | RHA | 40 | 250 | Green (RoHS & no Sb/Br) | CU NIPDAU | Level-3-260C-168 HR | -40 to 125 | TPS 65251-1 | Samples |
| TPS65251-2RHAR | ACTIVE | VQFN | RHA | 40 | 2500 | Green (RoHS & no Sb/Br) | CU NIPDAU | Level-3-260C-168 HR | -40 to 125 | TPS 65251-2 | Samples |
| TPS65251-2RHAT | ACTIVE | VQFN | RHA | 40 | 250 | Green (RoHS & no Sb/Br) | CU NIPDAU | Level-3-260C-168 HR | -40 to 125 | TPS 65251-2 | Samples |
| TPS65251-3RHAR | ACTIVE | VQFN | RHA | 40 | 2500 | Green (RoHS & no Sb/Br) | CU NIPDAU | Level-3-260C-168 HR | -40 to 125 | TPS 65251-3 | Samples |
| TPS65251-3RHAT | ACTIVE | VQFN | RHA | 40 | 250 | Green (RoHS & no Sb/Br) | CU NIPDAU | Level-3-260C-168 HR | -40 to 125 | TPS 65251-3 | Samples |

(1) The marketing status values are defined as follows:

ACTIVE: Product device recommended for new designs.

LIFEBUY: TI has announced that the device will be discontinued, and a lifetime-buy period is in effect.

NRND: Not recommended for new designs. Device is in production to support existing customers, but TI does not recommend using this part in a new design.

PREVIEW: Device has been announced but is not in production. Samples may or may not be available.

OBSOLETE: TI has discontinued the production of the device.

(2) Eco Plan - The planned eco-friendly classification: Pb-Free (RoHS), Pb-Free (RoHS Exempt), or Green (RoHS & no Sb/Br) - please check <http://www.ti.com/productcontent> for the latest availability information and additional product content details.

TBD: The Pb-Free/Green conversion plan has not been defined.

Pb-Free (RoHS): TI's terms "Lead-Free" or "Pb-Free" mean semiconductor products that are compatible with the current RoHS requirements for all 6 substances, including the requirement that lead not exceed 0.1% by weight in homogeneous materials. Where designed to be soldered at high temperatures, TI Pb-Free products are suitable for use in specified lead-free processes.

Pb-Free (RoHS Exempt): This component has a RoHS exemption for either 1) lead-based flip-chip solder bumps used between the die and package, or 2) lead-based die adhesive used between the die and leadframe. The component is otherwise considered Pb-Free (RoHS compatible) as defined above.

Green (RoHS & no Sb/Br): TI defines "Green" to mean Pb-Free (RoHS compatible), and free of Bromine (Br) and Antimony (Sb) based flame retardants (Br or Sb do not exceed 0.1% by weight in homogeneous material)

(3) MSL, Peak Temp. - The Moisture Sensitivity Level rating according to the JEDEC industry standard classifications, and peak solder temperature.

(4) There may be additional marking, which relates to the logo, the lot trace code information, or the environmental category on the device.

(5) Multiple Device Markings will be inside parentheses. Only one Device Marking contained in parentheses and separated by a "~" will appear on a device. If a line is indented then it is a continuation of the previous line and the two combined represent the entire Device Marking for that device.

⁽⁶⁾ Lead/Ball Finish - Orderable Devices may have multiple material finish options. Finish options are separated by a vertical ruled line. Lead/Ball Finish values may wrap to two lines if the finish value exceeds the maximum column width.

Important Information and Disclaimer: The information provided on this page represents TI's knowledge and belief as of the date that it is provided. TI bases its knowledge and belief on information provided by third parties, and makes no representation or warranty as to the accuracy of such information. Efforts are underway to better integrate information from third parties. TI has taken and continues to take reasonable steps to provide representative and accurate information but may not have conducted destructive testing or chemical analysis on incoming materials and chemicals. TI and TI suppliers consider certain information to be proprietary, and thus CAS numbers and other limited information may not be available for release.

In no event shall TI's liability arising out of such information exceed the total purchase price of the TI part(s) at issue in this document sold by TI to Customer on an annual basis.

TAPE AND REEL INFORMATION

QUADRANT ASSIGNMENTS FOR PIN 1 ORIENTATION IN TAPE

*All dimensions are nominal

| Device | Package Type | Package Drawing | Pins | SPQ | Reel Diameter (mm) | Reel Width W1 (mm) | A0 (mm) | B0 (mm) | K0 (mm) | P1 (mm) | W (mm) | Pin1 Quadrant |
|----------------|--------------|-----------------|------|------|--------------------|--------------------|---------|---------|---------|---------|--------|---------------|
| TPS65251-1RHAR | VQFN | RHA | 40 | 2500 | 330.0 | 16.4 | 6.3 | 6.3 | 1.1 | 12.0 | 16.0 | Q2 |
| TPS65251-1RHAT | VQFN | RHA | 40 | 250 | 180.0 | 16.4 | 6.3 | 6.3 | 1.1 | 12.0 | 16.0 | Q2 |
| TPS65251-2RHAR | VQFN | RHA | 40 | 2500 | 330.0 | 16.4 | 6.3 | 6.3 | 1.1 | 12.0 | 16.0 | Q2 |
| TPS65251-2RHAT | VQFN | RHA | 40 | 250 | 180.0 | 16.4 | 6.3 | 6.3 | 1.1 | 12.0 | 16.0 | Q2 |
| TPS65251-3RHAR | VQFN | RHA | 40 | 2500 | 330.0 | 16.4 | 6.3 | 6.3 | 1.1 | 12.0 | 16.0 | Q2 |
| TPS65251-3RHAT | VQFN | RHA | 40 | 250 | 180.0 | 16.4 | 6.3 | 6.3 | 1.1 | 12.0 | 16.0 | Q2 |

TAPE AND REEL BOX DIMENSIONS

*All dimensions are nominal

| Device | Package Type | Package Drawing | Pins | SPQ | Length (mm) | Width (mm) | Height (mm) |
|----------------|--------------|-----------------|------|------|-------------|------------|-------------|
| TPS65251-1RHAR | VQFN | RHA | 40 | 2500 | 367.0 | 367.0 | 38.0 |
| TPS65251-1RHAT | VQFN | RHA | 40 | 250 | 210.0 | 185.0 | 35.0 |
| TPS65251-2RHAR | VQFN | RHA | 40 | 2500 | 367.0 | 367.0 | 38.0 |
| TPS65251-2RHAT | VQFN | RHA | 40 | 250 | 210.0 | 185.0 | 35.0 |
| TPS65251-3RHAR | VQFN | RHA | 40 | 2500 | 367.0 | 367.0 | 38.0 |
| TPS65251-3RHAT | VQFN | RHA | 40 | 250 | 210.0 | 185.0 | 35.0 |

RHA (S-PVQFN-N40)

PLASTIC QUAD FLATPACK NO-LEAD

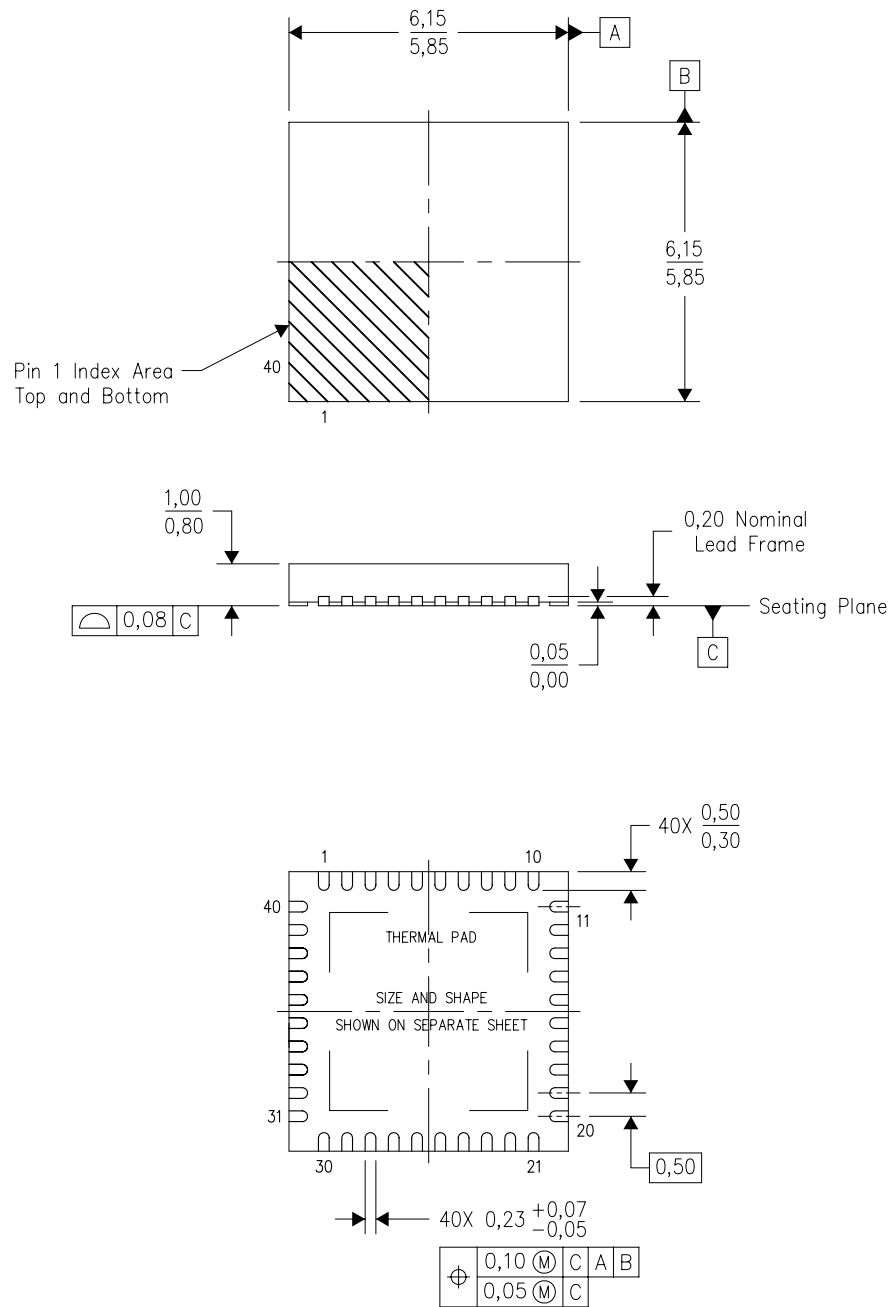

Bottom View

4204276/E 06/11

- NOTES:
- All linear dimensions are in millimeters. Dimensioning and tolerancing per ASME Y14.5M-1994.
 - This drawing is subject to change without notice.
 - QFN (Quad Flatpack No-Lead) Package configuration.
 - The package thermal pad must be soldered to the board for thermal and mechanical performance.
 - See the additional figure in the Product Data Sheet for details regarding the exposed thermal pad features and dimensions.
 - Package complies to JEDEC MO-220 variation VJJD-2.

THERMAL PAD MECHANICAL DATA

RHA (S-PVQFN-N40)

PLASTIC QUAD FLATPACK NO-LEAD

THERMAL INFORMATION

This package incorporates an exposed thermal pad that is designed to be attached directly to an external heatsink. The thermal pad must be soldered directly to the printed circuit board (PCB). After soldering, the PCB can be used as a heatsink. In addition, through the use of thermal vias, the thermal pad can be attached directly to the appropriate copper plane shown in the electrical schematic for the device, or alternatively, can be attached to a special heatsink structure designed into the PCB. This design optimizes the heat transfer from the integrated circuit (IC).

For information on the Quad Flatpack No-Lead (QFN) package and its advantages, refer to Application Report, QFN/SON PCB Attachment, Texas Instruments Literature No. SLUA271. This document is available at www.ti.com.

The exposed thermal pad dimensions for this package are shown in the following illustration.

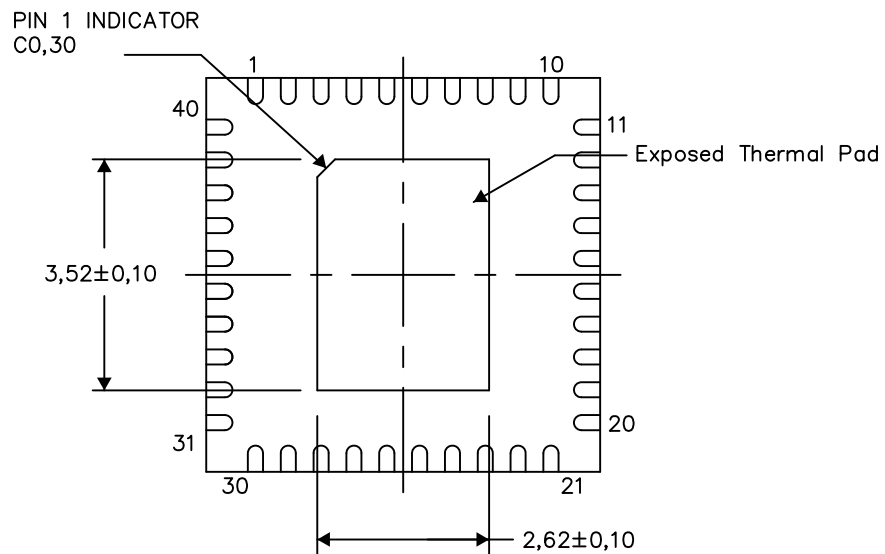

Bottom View

Exposed Thermal Pad Dimensions

4206355-9/X 08/14

NOTES: A. All linear dimensions are in millimeters

RHA (S-PVQFN-N40)

PLASTIC QUAD FLATPACK NO-LEAD

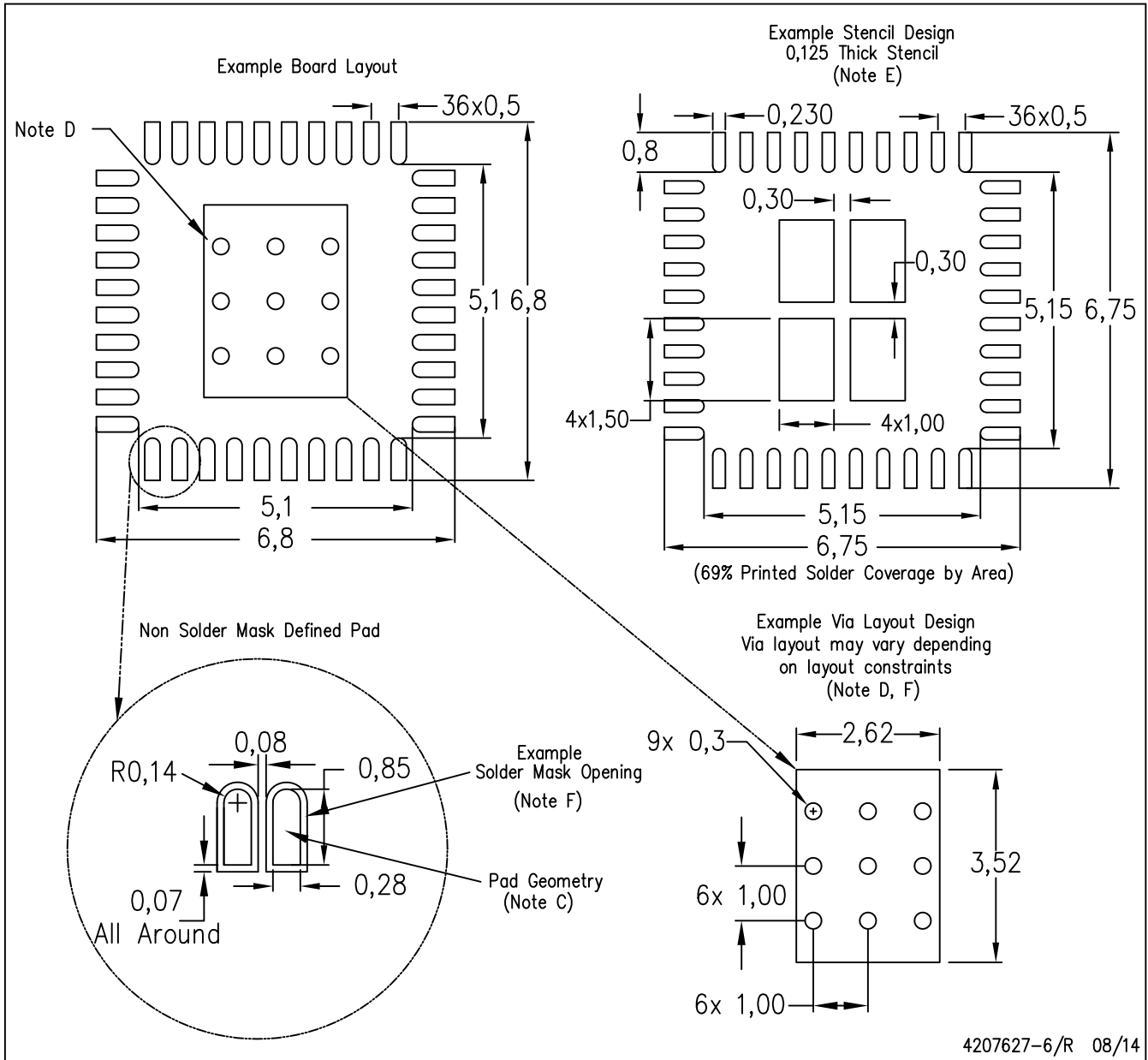

4207627-6/R 08/14

- NOTES:
- A. All linear dimensions are in millimeters.
 - B. This drawing is subject to change without notice.
 - C. Publication IPC-7351 is recommended for alternate designs.
 - D. This package is designed to be soldered to a thermal pad on the board. Refer to Application Note, Quad Flat-Pack Packages, Texas Instruments Literature No. SLUA271, and also the Product Data Sheets for specific thermal information, via requirements, and recommended board layout. These documents are available at www.ti.com <<http://www.ti.com>>.
 - E. Laser cutting apertures with trapezoidal walls and also rounding corners will offer better paste release. Customers should contact their board assembly site for stencil design recommendations. Refer to IPC 7525 for stencil design considerations.
 - F. Customers should contact their board fabrication site for recommended solder mask tolerances and via tenting recommendations for vias placed in the thermal pad.

IMPORTANT NOTICE

Texas Instruments Incorporated and its subsidiaries (TI) reserve the right to make corrections, enhancements, improvements and other changes to its semiconductor products and services per JESD46, latest issue, and to discontinue any product or service per JESD48, latest issue. Buyers should obtain the latest relevant information before placing orders and should verify that such information is current and complete. All semiconductor products (also referred to herein as "components") are sold subject to TI's terms and conditions of sale supplied at the time of order acknowledgment.

TI warrants performance of its components to the specifications applicable at the time of sale, in accordance with the warranty in TI's terms and conditions of sale of semiconductor products. Testing and other quality control techniques are used to the extent TI deems necessary to support this warranty. Except where mandated by applicable law, testing of all parameters of each component is not necessarily performed.

TI assumes no liability for applications assistance or the design of Buyers' products. Buyers are responsible for their products and applications using TI components. To minimize the risks associated with Buyers' products and applications, Buyers should provide adequate design and operating safeguards.

TI does not warrant or represent that any license, either express or implied, is granted under any patent right, copyright, mask work right, or other intellectual property right relating to any combination, machine, or process in which TI components or services are used. Information published by TI regarding third-party products or services does not constitute a license to use such products or services or a warranty or endorsement thereof. Use of such information may require a license from a third party under the patents or other intellectual property of the third party, or a license from TI under the patents or other intellectual property of TI.

Reproduction of significant portions of TI information in TI data books or data sheets is permissible only if reproduction is without alteration and is accompanied by all associated warranties, conditions, limitations, and notices. TI is not responsible or liable for such altered documentation. Information of third parties may be subject to additional restrictions.

Resale of TI components or services with statements different from or beyond the parameters stated by TI for that component or service voids all express and any implied warranties for the associated TI component or service and is an unfair and deceptive business practice. TI is not responsible or liable for any such statements.

Buyer acknowledges and agrees that it is solely responsible for compliance with all legal, regulatory and safety-related requirements concerning its products, and any use of TI components in its applications, notwithstanding any applications-related information or support that may be provided by TI. Buyer represents and agrees that it has all the necessary expertise to create and implement safeguards which anticipate dangerous consequences of failures, monitor failures and their consequences, lessen the likelihood of failures that might cause harm and take appropriate remedial actions. Buyer will fully indemnify TI and its representatives against any damages arising out of the use of any TI components in safety-critical applications.

In some cases, TI components may be promoted specifically to facilitate safety-related applications. With such components, TI's goal is to help enable customers to design and create their own end-product solutions that meet applicable functional safety standards and requirements. Nonetheless, such components are subject to these terms.

No TI components are authorized for use in FDA Class III (or similar life-critical medical equipment) unless authorized officers of the parties have executed a special agreement specifically governing such use.

Only those TI components which TI has specifically designated as military grade or "enhanced plastic" are designed and intended for use in military/aerospace applications or environments. Buyer acknowledges and agrees that any military or aerospace use of TI components which have **not** been so designated is solely at the Buyer's risk, and that Buyer is solely responsible for compliance with all legal and regulatory requirements in connection with such use.

TI has specifically designated certain components as meeting ISO/TS16949 requirements, mainly for automotive use. In any case of use of non-designated products, TI will not be responsible for any failure to meet ISO/TS16949.

Products

| | |
|------------------------------|--|
| Audio | www.ti.com/audio |
| Amplifiers | amplifier.ti.com |
| Data Converters | dataconverter.ti.com |
| DLP® Products | www.dlp.com |
| DSP | dsp.ti.com |
| Clocks and Timers | www.ti.com/clocks |
| Interface | interface.ti.com |
| Logic | logic.ti.com |
| Power Mgmt | power.ti.com |
| Microcontrollers | microcontroller.ti.com |
| RFID | www.ti-rfid.com |
| OMAP Applications Processors | www.ti.com/omap |
| Wireless Connectivity | www.ti.com/wirelessconnectivity |

Applications

| | |
|-------------------------------|--|
| Automotive and Transportation | www.ti.com/automotive |
| Communications and Telecom | www.ti.com/communications |
| Computers and Peripherals | www.ti.com/computers |
| Consumer Electronics | www.ti.com/consumer-apps |
| Energy and Lighting | www.ti.com/energy |
| Industrial | www.ti.com/industrial |
| Medical | www.ti.com/medical |
| Security | www.ti.com/security |
| Space, Avionics and Defense | www.ti.com/space-avionics-defense |
| Video and Imaging | www.ti.com/video |

TI E2E Community

e2e.ti.com