

TPS62840 1.8-V to 6.5-V, 750-mA, 60-nA I_Q Step-Down Converter

1 Features

- 60-nA operating quiescent current
- 100% duty-cycle mode with 120-nA I_Q
- Input voltage range V_{IN} from 1.8 V to 6.5 V
- Output current up to 750 mA
- RF friendly DCS-Control™
- 80% efficiency at 1 μA I_{OUT} (3.6 V_{IN} to 1.8 V_{OUT})
- 16 selectable output voltages via VSET pin
- Auto transition PFM/PWM or forced-PWM mode
- Selectable forced PWM and STOP modes
- Output discharge function
- 25-nA shutdown current
- SON-8, WCSP-6 and thermally enhanced HVSSOP-8 packages

2 Applications

- [Smart meters, smart thermostats](#)
- [Asset tracking devices](#)
- [Wearable electronics](#)
- [Medical sensor patches and patient monitors](#)
- [Industrial IoT \(smart sensors\) / NB-IoT](#)
- [Test and measurement](#)
- ATEX / intrinsic safety

3 Description

The TPS62840 is a high-efficiency step-down converter with ultra-low operating quiescent current of typically 60 nA. The device contains special circuitry to achieve just 120 nA I_Q in 100% mode to further extend battery life near the end of discharge.

The device uses DCS-Control to cleanly power radios and operates with a typical switching frequency of 1.8 MHz. In Power-Save Mode, the device extends the light load efficiency down to a load current range of 1 μA and below.

16 predefined output voltages can be selected by connecting a resistor to pin VSET, making the device flexible for various applications with a minimum amount of external components.

The STOP pin of the device immediately eliminates any switching noise in order to take a noise-free measurement in test and measurement systems.

The TPS62840 provides an output current of up to 750 mA. With an input voltage of 1.8 V to 6.5 V, the device supports multiple power sources such as 2S to 4S Alkaline, 1S to 2S Li-MnO₂, or 1S Li-Ion/Li-SOCl₂.

Device Information⁽¹⁾

PART NUMBER	PACKAGE	BODY SIZE (NOM)
TPS6284x	8 pin DLC (SON)	1.5 mm x 2 mm
	6 pin YBG (WCSP)	0.97 mm x 1.47 mm
	8 pin DGR (HVSSOP)	3 mm x 5 mm

(1) For all available packages, see the orderable addendum at the end of the datasheet.

Typical Application

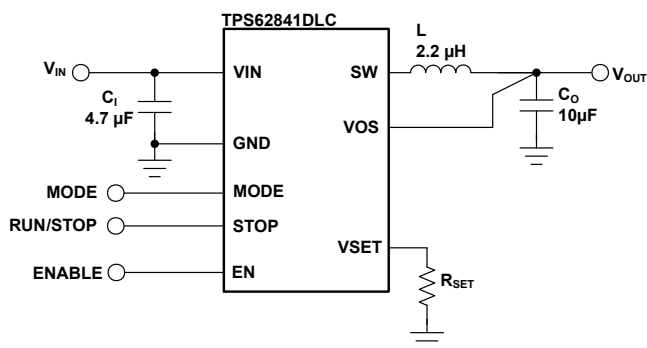

Efficiency versus Load Current (V_{OUT} = 1.8 V)

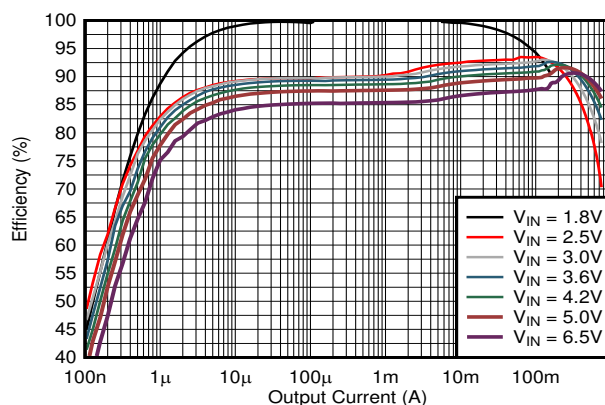

D002



Table of Contents

1 Features	1	8.4 Device Functional Modes.....	15
2 Applications	1	9 Application and Implementation	16
3 Description	1	9.1 Application Information.....	16
4 Revision History	2	9.2 Typical Application	16
5 Device Comparison Table	3	9.3 System Example	27
6 Pin Configuration and Functions	4	10 Power Supply Recommendations	28
7 Specifications	6	11 Layout	28
7.1 Absolute Maximum Ratings	6	11.1 Layout Guidelines	28
7.2 ESD Ratings.....	6	11.2 Layout Example	28
7.3 Recommended Operating Conditions.....	6	12 Device and Documentation Support	30
7.4 Thermal Information	6	12.1 Device Support.....	30
7.5 Electrical Characteristics.....	7	12.2 Support Resources	30
7.6 Typical Characteristics	9	12.3 Trademarks	30
8 Detailed Description	11	12.4 Electrostatic Discharge Caution.....	30
8.1 Overview	11	12.5 Glossary	30
8.2 Functional Block Diagram	11	13 Mechanical, Packaging, and Orderable Information	30
8.3 Feature Description.....	12		

4 Revision History

NOTE: Page numbers for previous revisions may differ from page numbers in the current version.

Changes from Revision C (November 2019) to Revision D	Page
• Updated the Device Comparison Table	3
• Added efficiency graphs to the Application Curves	20

Changes from Revision B (August 2019) to Revision C	Page
• Added SON-8, WCSP-6, and thermally enhanced HVSSOP-8 to <i>Features</i>	1
• Added ATEX / Intrinsic safety to <i>Applications</i>	1
• Updated Typical Application image to show TPS62842DGR device	1
• Added orderable part number TPS62841DGR to <i>Device Comparison Table</i>	3
• Added orderable part number TPS62842DGR to <i>Device Comparison Table</i>	3
• Updated <i>Thermal Information</i> values to support TPS62842DGR	6
• Added low-side MOSFET switch current limit to <i>Electrical Characteristics</i>	8
• Added TPS62841DGR to <i>Output Voltage Selection</i>	13
• Updated Efficiency Power Save graphs in <i>Application Curves</i>	20
• Updated Load Transient waveform in <i>Application Curves</i>	24
• Added PCB layout for DGR package	29

Changes from Revision A (July 2019) to Revision B	Page
• Changed Advance Information marketing status to Production Data	1

5 Device Comparison Table

ORDERABLE PART NUMBER	OUTPUT VOLTAGE	OUTPUT CURRENT	OUTPUT DISCHARGE	MODE PIN	STOP PIN	PACKAGE	PACKAGE MARKING
TPS62840DLC	1.8 V to 3.3 V in 100-mV steps	750 mA	yes	yes	yes	SON-8 (DLC)	E5
TPS62840YBG				no	no	WCSP-6 (YBG)	62840
TPS62841DLC	0.8 V to 1.55 V in 50-mV steps	750 mA	yes	yes	yes	SON-8 (DLC)	E9
TPS62841YBG				no	no	WCSP-6 (YBG)	62841
TPS62841DGR				yes	no	HVSSOP-8 (DGR)	62841
TPS62842DGR	1.8 V, 2.0 V, 2.2 V, 2.4 V to 3.6 V in 100-mV steps	750 mA	yes	yes	no	HVSSOP-8 (DGR)	62842
TPS62849DLC	3.4-V fixed output voltage				yes	SON-8 (DLC)	FF

6 Pin Configuration and Functions

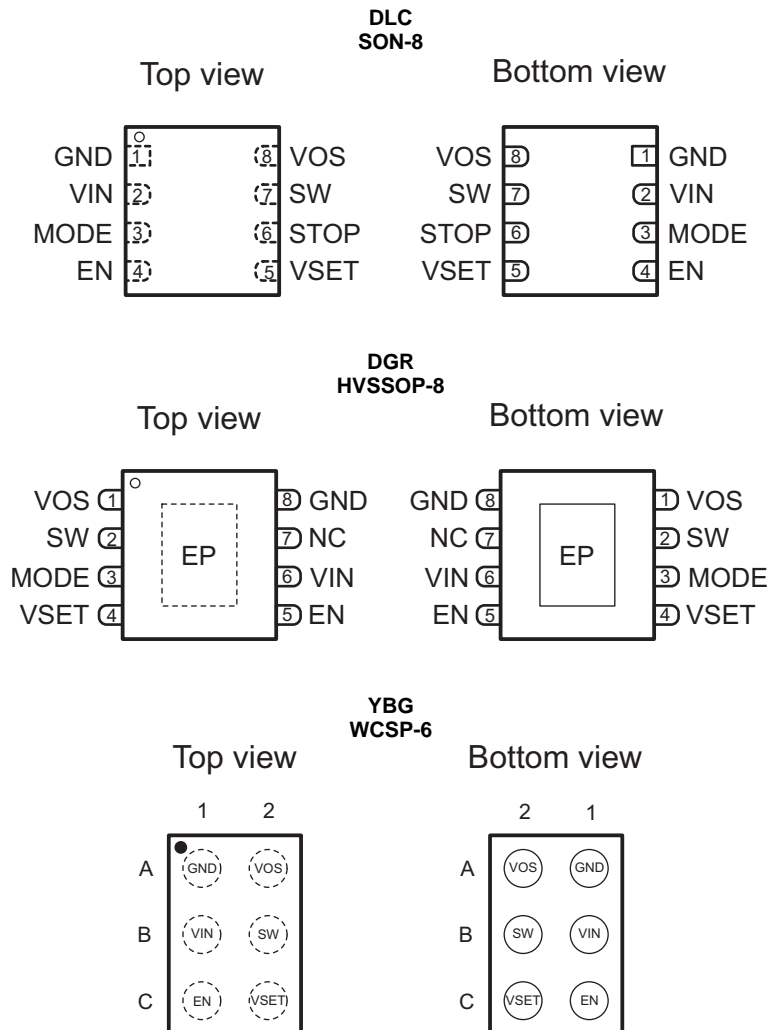

Pin Functions

NAME	PIN			I/O	DESCRIPTION
	DLC (SON-8)	DGR (HVSSOP-8)	YBG (WCSP-6)		
VIN	2	6	B1	PWR	V _{IN} power supply pin. Connect the input capacitor close to this pin for best noise and voltage spike suppression. A 4.7-μF ceramic capacitor is required.
SW	7	2	B2	PWR	The switch pin is connected to the internal MOSFET switches. Connect the inductor to this terminal.
GND	1	8	A1	PWR	GND supply pin. Connect this pin close to the GND terminal of the input and output capacitors.
VSET	5	4	C2	IN	Connecting a resistor to GND sets the output voltage when the converter is enabled. For the TPS62849, connect this pin to GND.
VOS	8	1	A2	IN	Output voltage sense pin for the internal feedback divider network and regulation loop. When the converter is disabled, this pin discharges V _{OUT} by an internal MOSFET. Connect this pin directly to the output capacitor with a short trace.
EN	4	5	C1	IN	Enable pin. A high level enables the device and a low level turns the device off. The pin features an internal pulldown resistor, which is disabled once the device has started up and the output voltage is regulated. The pulldown resistor is activated again, once a low level has been detected.
STOP	6	n/a	n/a	IN	STOP Switching pin. When this pin is logic high, the converter stops switching in order to provide a quiet supply rail. The output is powered from the charge available in the output capacitor. When this pin is logic low, the device immediately resumes operation. The pin features an internal pulldown resistor, which is disabled once a high level is detected at the input. The pulldown resistor is activated again, once a low level has been detected.
MODE	3	3	n/a	IN	MODE pin. A low level enables Power-Save Mode operation with an automatic transition between PFM and PWM modes. A high level forces the converter to operated in PWM mode. This pin can be toggled during operation. It must be terminated.
NC	n/a	7	n/a		This pin is not connected internally. Do not connect this pin.
EP	n/a	9	n/a	PWR	Exposed thermal pad ⁽¹⁾ . The PowerPAD must be connected to GND.

(1) For more information about the PowerPAD, see the [PowerPAD™ Thermally Enhanced Package](#) application report.

7 Specifications

7.1 Absolute Maximum Ratings⁽¹⁾

		MIN	MAX	UNIT
Pin voltage ⁽²⁾	V _{IN}	-0.3	7	V
	SW (DC)	-0.3	V _{IN} + 0.3	V
	SW (AC), less than 10ns ⁽³⁾	-2.0	8.5	V
	EN, MODE, STOP	-0.3	6.5	V
	VSET	-0.3	V _{IN} + 0.3 < 3.6	V
	VOS	-0.3	3.7	V
Operating junction temperature, T _J		-40	150	°C
Storage temperature, T _{stg}		-65	150	°C

- (1) Stresses beyond those listed under *absolute maximum ratings* may cause permanent damage to the device. These are stress ratings only and functional operation of the device at these or any other conditions beyond those indicated under *recommended operating conditions* is not implied. Exposure to absolute–maximum–rated conditions for extended periods may affect device reliability.
- (2) All voltage values are with respect to network ground terminal GND.
- (3) While switching.

7.2 ESD Ratings

			VALUE	UNIT
V _(ESD)	Electrostatic discharge	Human body model (HBM), per ANSI/ESDA/JEDEC JS-001, all pins ⁽¹⁾	±2000	V
		Charged device model (CDM), per JEDEC specification JESD22-C101, all pins ⁽²⁾	±500	

- (1) JEDEC document JEP155 states that 500-V HBM allows safe manufacturing with a standard ESD control process. The human body model is a 100-pF capacitor discharged through a 1.5-kΩ resistor into each pin.
- (2) JEDEC document JEP157 states that 250-V CDM allows safe manufacturing with a standard ESD control process.

7.3 Recommended Operating Conditions

		MIN	NOM	MAX	UNIT
V _{IN}	Supply voltage V _{IN}	1.8		6.5	V
L	Effective inductance	1.51	2.2	2.9	μH
C _{OUT}	Effective output capacitance	3	10	40	μF
C _{IN}	Effective input capacitance	1	4.7		μF
C _{VSET}	External parasitic capacitance at VSET pin			100	pF
R _{SET}	Nominal resistance range for external voltage selection resistor (E96 resistor series)	0.909		267	kΩ
	External voltage selection resistor tolerance			1%	
	External voltage selection resistor temperature coefficient			±200	ppm/°C
T _J	Operating junction temperature range	-40		125	°C

7.4 Thermal Information

THERMAL METRIC ⁽¹⁾		8 Pins DLC Package	6 Pins YBG Package	8 Pins DGR Package	DGR EVM	UNIT
		JEDEC PCB 51-7		JEDEC PCB 51-5	TPS62841-2EVM123	
R _{θJA}	Junction-to-ambient thermal resistance	105.6	133.4	54.4	46.9	°C/W
R _{θJC(top)}	Junction-to-case (top) thermal resistance	75.7	0.4	58.1	N/A	°C/W
R _{θJB}	Junction-to-board thermal resistance	31.9	39.4	25.9	N/A	°C/W
ψ _{JT}	Junction-to-top characterization parameter	2.3	0.1	1.2	0.9	°C/W
ψ _{JB}	Junction-to-board characterization parameter	31.5	39.4	25.9	17.4	°C/W
R _{θJC(bot)}	Junction-to-case (bottom) thermal resistance	n/a	n/a	11.7	N/A	°C/W

- (1) For more information about traditional and new thermal metrics, see the [Semiconductor and IC Package Thermal Metrics](#) application report.

7.5 Electrical Characteristics

 $V_{IN} = 3.6\text{ V}$, $T_J = -40^\circ\text{C}$ to 125°C , STOP = GND, MODE = GND, typical values are at $T_J = 25^\circ\text{C}$ (unless otherwise noted)

PARAMETER		TEST CONDITIONS	MIN	TYP	MAX	UNIT
SUPPLY						
$I_{Q_NO_LOAD}$	No load operating input current	EN = V_{IN} , $I_{OUT} = 0\mu\text{A}$, $V_{OUT} = 1.8\text{V}$ device switching		60		nA
$I_{Q_NO_LOAD}$	No load operating input current	EN = V_{IN} , $I_{OUT} = 0\mu\text{A}$, $V_{OUT} = 1.2\text{V}$ device switching		80		nA
$I_{Q_NO_LOAD}$	No load operating input current (PWM Mode)	EN = V_{IN} , $I_{OUT} = 0\mu\text{A}$, $V_{OUT} = 1.8\text{V}$, MODE = V_{IN} device switching		3		mA
I_{Q_VIN}	Operating quiescent current into pin VIN	EN = V_{IN} , $I_{OUT} = 0\mu\text{A}$, $V_{OUT} = 1.55\text{V}$ or $V_{OUT} = 1.8\text{V}$ device not switching, $T_J = 25^\circ\text{C}$ (DLC package option)		36	100	nA
I_{Q_VOS}	Operating quiescent current into pin VOS	EN = V_{IN} , $I_{OUT} = 0\mu\text{A}$, $V_{OUT} = 1.55\text{V}$ or $V_{OUT} = 1.8\text{V}$ device not switching, $T_J = 25^\circ\text{C}$ (DLC package option)		56	120	nA
I_{Q_VIN}	Operating quiescent current into pin VIN	EN = V_{IN} , $I_{OUT} = 0\mu\text{A}$, $V_{OUT} = 1.55\text{V}$ or $V_{OUT} = 1.8\text{V}$ device not switching, $T_J = -40^\circ\text{C}$ to 85°C		36	360	nA
I_{Q_VOS}	Operating quiescent current into pin VOS	EN = V_{IN} , $I_{OUT} = 0\mu\text{A}$, $V_{OUT} = 1.55\text{V}$ or $V_{OUT} = 1.8\text{V}$ device not switching, $T_J = -40^\circ\text{C}$ to 85°C		56	170	nA
I_{Q_VOS}	Operating quiescent current into VOS pin	EN = V_{IN} , $V_{OUT} = 3.3\text{V}$ device not switching		70		nA
		EN = V_{IN} , $V_{OUT} < 1.5\text{V}$ device not switching		5		nA
		EN, STOP = V_{IN} , $3\text{V} < V_{OUT} < 3.3\text{V}$ $T_J = -40^\circ\text{C}$ to 85°C		5	100	nA
$I_{Q_100\%_MODE}$	Operating quiescent current 100% Mode	$V_{IN} = V_{OUT} = 3.3\text{V}$, $T_J = -40^\circ\text{C}$ to 85°C		120		nA
$I_{Q_VIN_STOP}$	Operating quiescent current into pin VIN	STOP = High, $V_{OUT} = 1.8\text{V}$, $T_J = -40^\circ\text{C}$ to 85°C		70	175	μA
I_{SD}	Shutdown current	EN = GND, shutdown current into V_{IN} VSET = GND, $T_J = -40^\circ\text{C}$ to 85°C		25	300	nA
V_{TH_UVLO+}	Undervoltage lockout threshold	Rising V_{IN}		1.72	1.8	V
V_{TH_UVLO-}		Falling V_{IN}		1.45	1.75	V
EN, MODE, STOP INPUTS						
V_{IH_TH}	High level input voltage		1.1			V
V_{IL_TH}	Low level input voltage				0.4	V
I_{IN}	Input bias current	MODE input, $T_J = -40^\circ\text{C}$ to 85°C		1	25	nA
R_{PD}	Internal pull-down resistance	EN, STOP inputs	200	450		k Ω

Electrical Characteristics (continued)

 $V_{IN} = 3.6\text{ V}$, $T_J = -40^\circ\text{C}$ to 125°C , STOP = GND, MODE = GND, typical values are at $T_J = 25^\circ\text{C}$ (unless otherwise noted)

PARAMETER		TEST CONDITIONS	MIN	TYP	MAX	UNIT
POWER SWITCHES						
$R_{DS(ON)}$	High-side MOSFET on-resistance (DLC, YBG package)	$V_{IN} = 3.6\text{ V}$, $I = 200\text{ mA}$, $T_J = -40^\circ\text{C}$ to 85°C		430	600	$m\Omega$
		$V_{IN} = 5\text{ V}$, $I = 200\text{ mA}$, $T_J = -40^\circ\text{C}$ to 85°C		340	465	
	Low-side MOSFET on-resistance (DLC, YBG package)	$V_{IN} = 3.6\text{ V}$, $I = 200\text{ mA}$, $T_J = -40^\circ\text{C}$ to 85°C		170	240	$m\Omega$
		$V_{IN} = 5\text{ V}$, $I = 200\text{ mA}$, $T_J = -40^\circ\text{C}$ to 85°C		135	180	
	High-side MOSFET on-resistance (DGR package)	$V_{IN} = 3.6\text{ V}$, $I = 200\text{ mA}$, $T_J = -40^\circ\text{C}$ to 85°C		460	630	$m\Omega$
		$V_{IN} = 5\text{ V}$, $I = 200\text{ mA}$, $T_J = -40^\circ\text{C}$ to 85°C		370	495	
Low-side MOSFET on-resistance (DGR package)	$V_{IN} = 3.6\text{ V}$, $I = 200\text{ mA}$, $T_J = -40^\circ\text{C}$ to 85°C		200	270	$m\Omega$	
	$V_{IN} = 5\text{ V}$, $I = 200\text{ mA}$, $T_J = -40^\circ\text{C}$ to 85°C		165	210		
I_{LIMF_SS}	Soft-start switch current limit ⁽¹⁾		0.15	0.225	0.3	A
I_{LIMF}	High-side MOSFET switch current limit ⁽¹⁾		1.0	1.2	1.4	A
	Low-side MOSFET switch current limit			1.0		A
I_{LIMN}	Negative current limit			533		mA
t_{LIM_DELAY}	Current limit propagation delay			50		ns
I_{LKG_SW}	Leakage current into SW pin	$V_{SW} = 1.8\text{ V}$, $T_J = -40^\circ\text{C}$ to 85°C		10		nA
OUTPUT VOLTAGE DISCHARGE						
$I_{DISCHARGE_VOS}$	Output discharge current	EN = GND, sink current into VOS pin, over VIN range $V_{OUT} = 1.8\text{ V}$, $T_J = -40^\circ\text{C}$ to 85°C	16	35	44	mA
THERMAL PROTECTION						
T_{SD}	Thermal shutdown temperature	Rising junction temperature, PWM Mode		160		$^\circ\text{C}$
	Thermal shutdown hysteresis			5		$^\circ\text{C}$
OUTPUT						
V_{OUT}	Output voltage accuracy	PWM Mode, $I_{OUT} = 0\text{ mA}$, $V_{OUT} \geq 1.8\text{ V}$	-1.5	0	1.5	%
		PWM Mode, $I_{OUT} = 0\text{ mA}$, $V_{OUT} \leq 1.55\text{ V}$	-2	0	2	%
V_{OUT}	DC output voltage load regulation	PWM Mode		0		%/mA
	DC output voltage line regulation	PWM Mode $V_{OUT} = 1.8\text{ V}$, $I_{OUT} = 200\text{ mA}$, over VIN range		0		%/V
f_{SW}	Switching frequency	$V_{IN} = 3.6\text{ V}$, $V_{OUT} = 1.8\text{ V}$, MODE = V_{IN} $I_{OUT} = 0\text{ mA}$		1.8		MHz
$t_{STARTUP_DELAY}$	Regulator start up delay time	$V_{IN} = 3.6\text{ V}$, from EN = low to high until device starts switching			200	μs
$t_{STARTUP_DELAY}$	Regulator start up delay time	EN ramps with VIN, VIN 0 to 3.6V (< 100us), until device starts switching		10		ms
t_{SS}	Soft-start time	$I_{OUT} = 0\text{ mA}$		120		μs
t_{SS_ILIMF}	Reduced current limit soft-start timeout			700	1200	μs

(1) This is the static current limit. It can be temporarily higher in applications due to internal propagation delay (see [Switch Current Limit / Short Circuit Protection](#) section).

7.6 Typical Characteristics

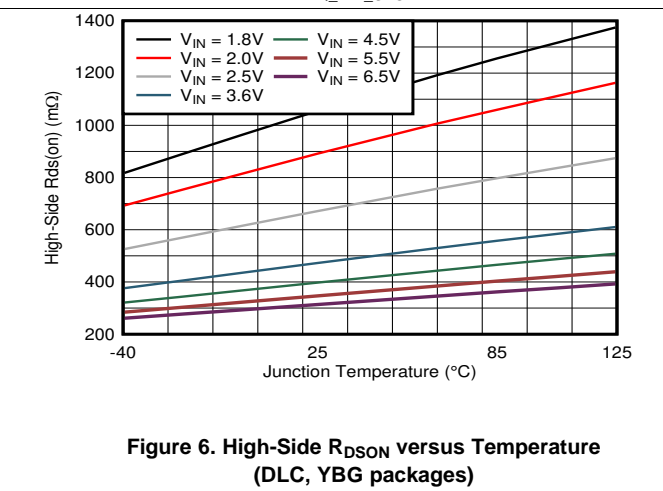
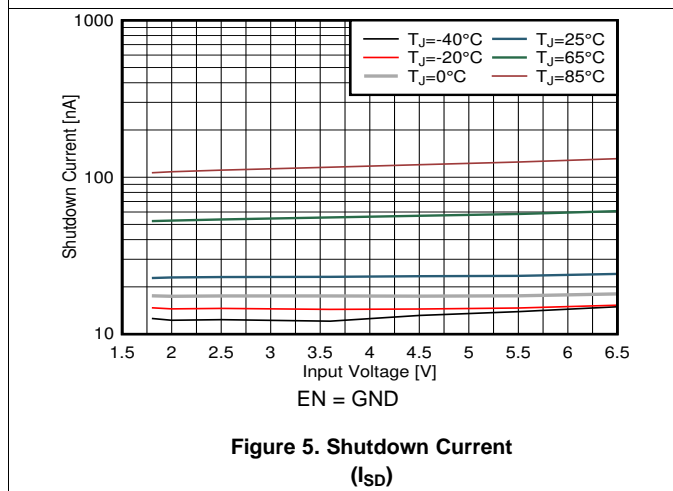
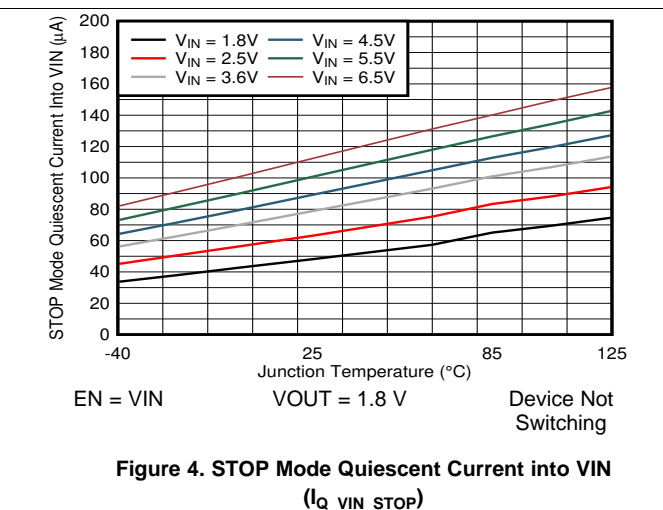
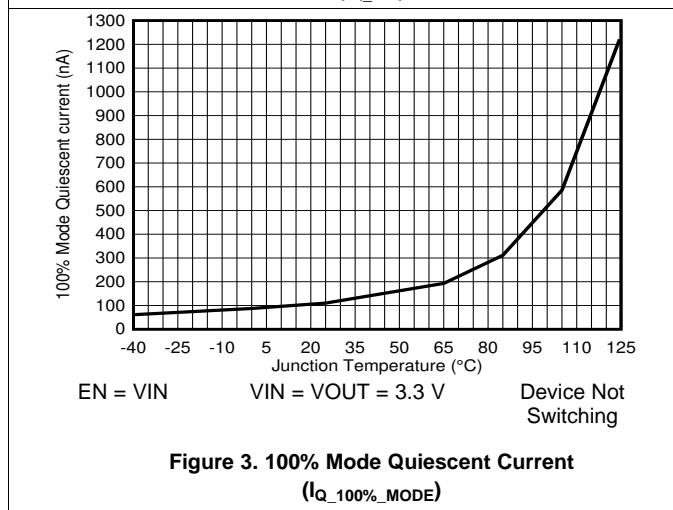
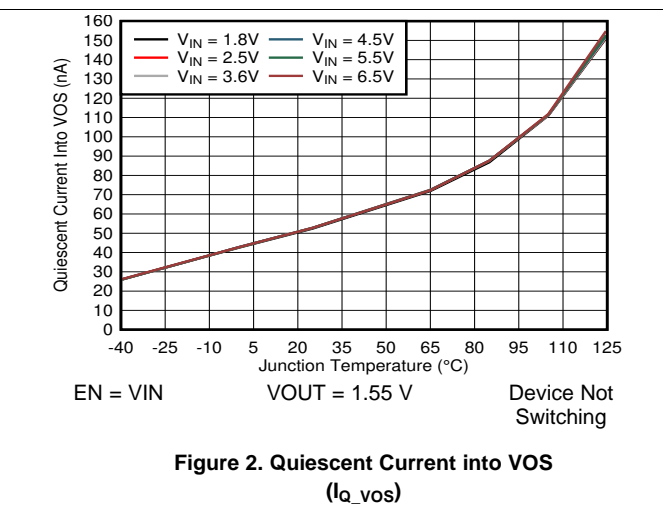
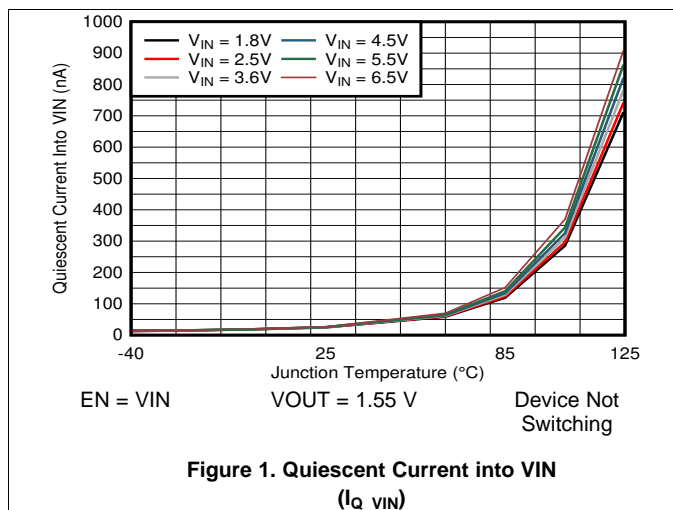

Typical Characteristics (continued)

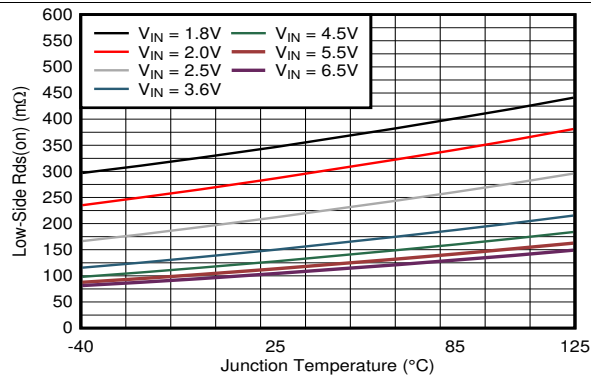

Figure 7. Low-Side $R_{DS(on)}$ versus Temperature (DLC, YBG packages)

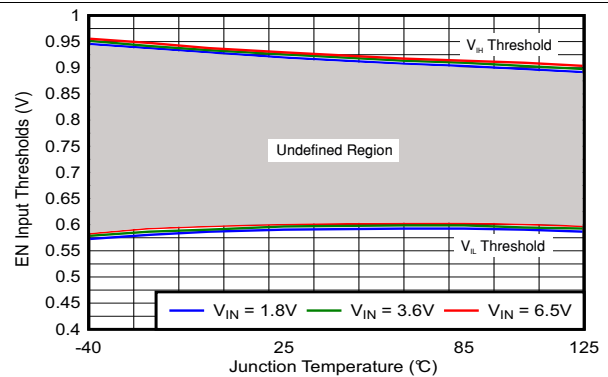

Figure 8. EN Input Thresholds versus Temperature

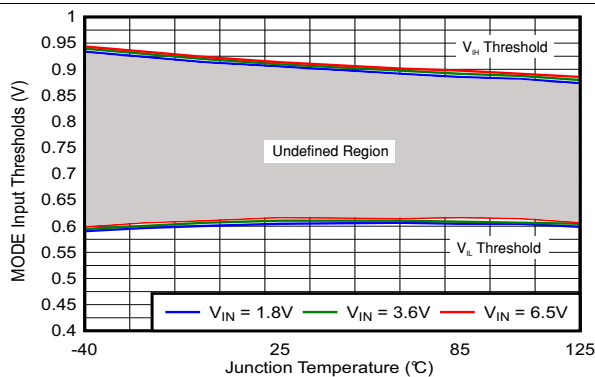

Figure 9. MODE Input Thresholds versus Temperature

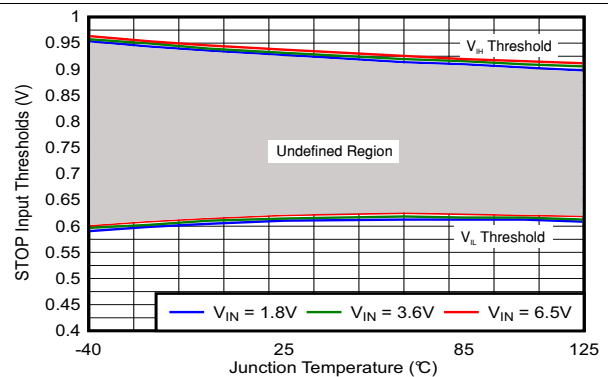

Figure 10. STOP Input Thresholds versus Temperature

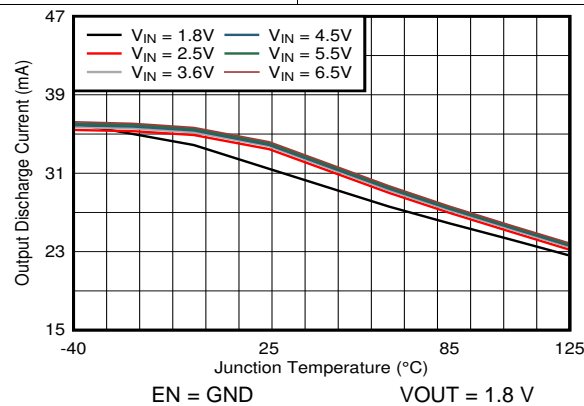

Figure 11. Output Discharge Current versus Temperature

8 Detailed Description

8.1 Overview

The TPS6284x is a synchronous step-down converter with ultra-low quiescent current consumption. Using TI's DCS-Control topology, the device extends the high efficiency operation area down to micro amperes of load current during Power-Save Mode Operation. Depending on the output voltage, the device consumes quiescent current from both the input and output to reduce the overall input current consumption to 60 nA typical.

DCS-Control™ (Direct Control with Seamless Transition into Power-Save Mode) is an advanced regulation topology that combines the advantages of hysteretic and voltage mode controls. Characteristics of DCS-Control are excellent AC load regulation and transient response, low output ripple voltage, and a seamless transition between PFM and PWM modes. It includes a AC loop which senses the output voltage (VOS pin) and directly feeds this information into a fast comparator stage.

The device operates with a nominal switching frequency of 1.8 MHz. An additional voltage feedback loop is used to achieve accurate DC load regulation. The internally compensated regulation network achieves fast and stable operation with small external components and low ESR capacitors.

In Power-Save Mode, the switching frequency varies linearly with the load current. Since DCS-Control supports both operating modes, the transition from PWM to PFM is seamless with minimum output voltage ripple. The TPS6284x offers both, excellent DC voltage and superior load transient regulation, combined with low output voltage ripple thereby minimizing interferences with Radio Frequency circuits.

8.2 Functional Block Diagram

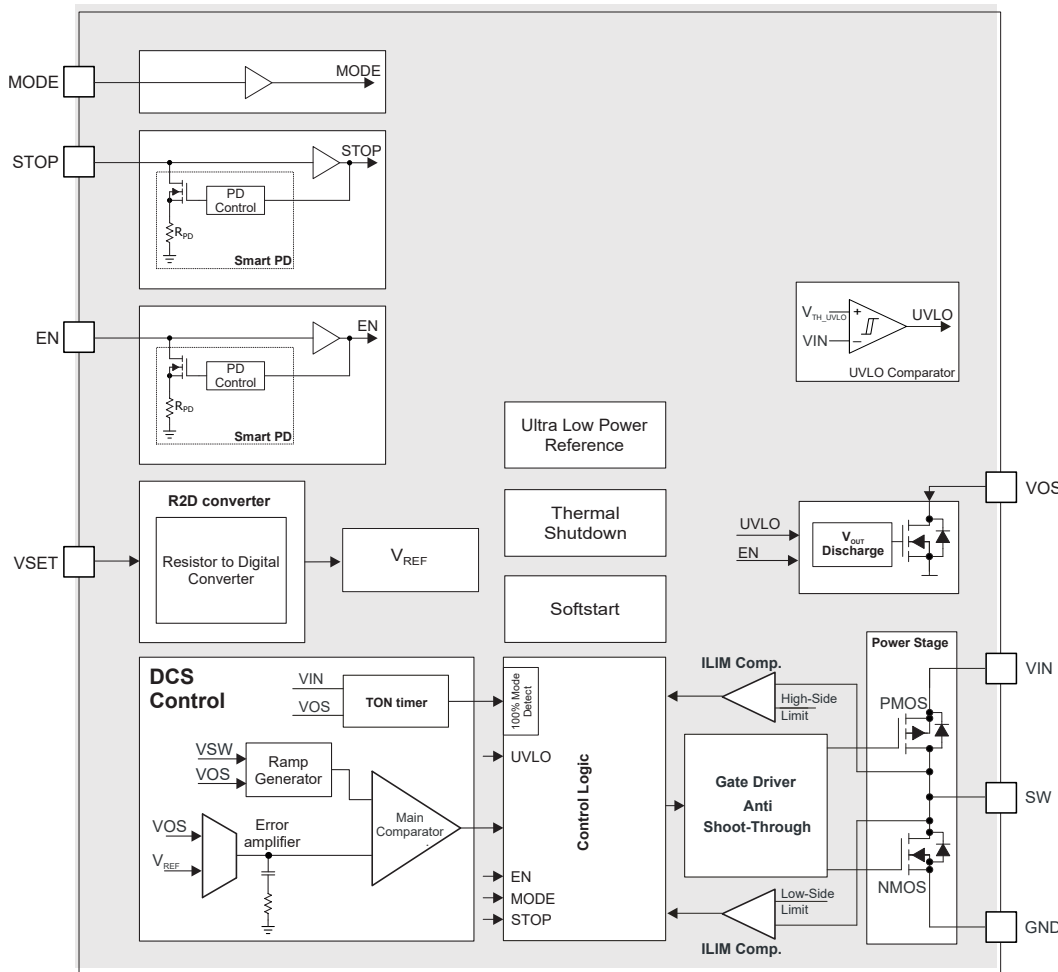

8.3 Feature Description

8.3.1 Smart Enable and Shutdown

To avoid a floating input, an internal 450-k Ω resistor pulls the EN pin to GND. This prevents an uncontrolled start-up of the device in case the EN pin cannot be driven low safely. The device is in shutdown mode when the EN input is logic low.

The device turns on with a logic high EN signal. An internal control circuit disconnects the EN pin pulldown resistor once the device has finished soft start and the output voltage is in regulation. With the EN pin set low, the device enters shutdown mode and the pulldown resistor is activated again.

8.3.2 Soft Start

To protect the battery and system from excessive inrush current, the device features a soft start of the output voltage.

Once the device has been enabled, it initializes and powers up its internal circuits. This occurs during the regulator start-up delay time ($t_{\text{STARTUP_DELAY}}$). Once this delay expires, the device enters soft start, starts switching, and ramps up the output voltage.

The device operates with a reduced switch current limit ($I_{\text{LIMF_SS}}$) throughout the entire soft-start phase (t_{SS}). The switch current limit is increased to its nominal value (I_{LIMF}) once the output voltage has reached its nominal value or the reduced current limit soft-start time ($t_{\text{SS_ILIMF}}$) has expired, whichever occurs first. The soft-start phase (t_{SS}) can last up to approximately 700 μs . [Figure 12](#) shows the start-up procedure.

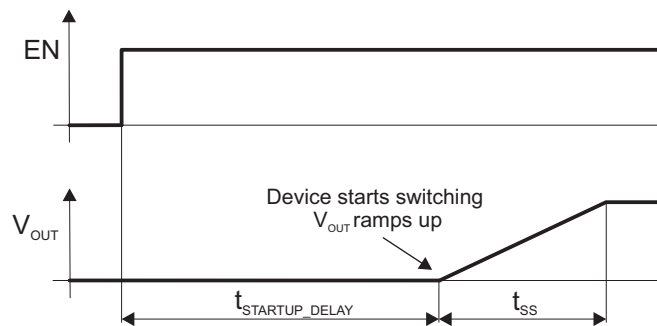

Figure 12. Device Start-up

8.3.3 Mode Selection: Power-Save Mode (PFM/PWM) or Forced PWM Operation (FPWM)

Connecting the MODE input to GND enables the automatic PWM and power-save mode operation. The converter operates in PWM mode at moderate to heavy loads and in the PFM mode during light loads, which maintains high efficiency over a wide load current range.

Pulling the MODE pin high forces the converter to operate in PWM mode even at light load currents, allowing lower ripple compared to PFM mode switching. In this mode, the efficiency is lower compared to the power-save mode during light loads. For additional flexibility, it is possible to switch from power-save mode to forced PWM mode during operation. This allows efficient power management by adjusting the operation of the converter to the specific system requirements. The MODE pin must be terminated.

This pin is not available in the YBG package, where the device automatically transitions between power-save and PWM modes.

8.3.4 Output Voltage Selection (VSET)

The output voltage is set with a single external resistor connected between the VSET pin and GND. Once the device has been enabled and the control logic as well as the reference system are powered up, an R2D (resistor to digital) conversion is started to detect the value of the external R_{SET} resistor. A pre-defined fixed output voltage is set based on the R_{SET} value. The output voltage is set once during the start-up delay phase of the device.

Feature Description (continued)

Once the output voltage is set, the R2D converter is turned off to avoid current flowing through R_{SET} . Care must be taken that no parasitic current, capacitance, or both greater than 100 pF is present between the VSET and GND pins. This can cause false R_{SET} readings and a faulty output voltage to be set. The R2D converter is designed to operate with resistor values out of E96 series. [Table 1](#) shows the allowed R_{SET} values.

Table 1. Output Voltage Setting, R_{SET} Resistor

OUTPUT VOLTAGE SETTING V_{OUT} [V]			VSET RESISTANCE TO GND - E96 VALUES [Ω]		
TPS62841YBG	TPS62840YBG	TPS62842DGR	MIN	NOM	MAX
TPS62841DLC	TPS62840DLC				
TPS62841DGR					
0.8	1.8	1.8	0	GND	0.01 k
0.85	1.9	2.0	0.87 k	0.909 k	0.95 k
0.9	2.0	2.2	1.67 k	1.74 k	1.81 k
0.95	2.1	2.4	2.76 k	2.87 k	2.98 k
1.0	2.2	2.5	4.15 k	4.32 k	4.49 k
1.05	2.3	2.6	5.80 k	6.04 k	6.28 k
1.1	2.4	2.7	8.11 k	8.45 k	8.79 k
1.15	2.5	2.8	11.04 k	11.5 k	11.96 k
1.2	2.6	2.9	15.17 k	15.8 k	16.43 k
1.25	2.7	3.0	20.64 k	21.5 k	22.36 k
1.3	2.8	3.1	27.55 k	28.7 k	29.85 k
1.35	2.9	3.2	36.77 k	38.3 k	39.83 k
1.4	3.0	3.3	50.21 k	52.3 k	54.39 k
1.45	3.1	3.4	68.64 k	71.5 k	74.36 k
1.5	3.2	3.49	97.92 k	102 k	106.08 k
1.55	3.3	3.6	256.32 k	267 k	277.68 k

The output voltage of the TPS62849 is internally set to 3.4 V. Connect VSET directly to GND for this device.

8.3.5 Undervoltage Lockout UVLO

To avoid mis-operation of the device at low input voltages, an undervoltage lockout (UVLO) comparator monitors the supply voltage. The UVLO comparator shuts down the device at an input below the threshold V_{TH_UVLO-} with falling V_{IN} . The device starts at an input voltage higher than the threshold V_{TH_UVLO+} with rising V_{IN} .

When the device resumes operation from an undervoltage lockout condition, it behaves like being enabled. This means the internal control logic is powered up, the external R_{SET} resistor is read out and a soft-start sequence is initiated.

8.3.6 Switch Current Limit / Short Circuit Protection

The TPS6284x integrates a current limit on the high-side as well as on the low-side MOSFETs to protect the device against overload or short circuit conditions. The current in the switches is monitored cycle-by-cycle. If the high-side MOSFET current limit (I_{LIMF}) trips, the high-side MOSFET is turned off and the low-side MOSFET is turned on to ramp the inductor current down. Once the inductor current decreases below the low-side current limit (I_{LIMF}), the low-side MOSFET turns off and the high-side MOSFET turns on again.

During soft start, the current limit is reduced to I_{LIMF_SS} . After soft start has finished, the current limit value increases to the normal value I_{LIMF} .

Due to internal propagation delay, the actual inductor current can exceed the static current limit during that time. The dynamic current limit can be calculated as follows:

$$I_{peak(typ)} = I_{LIMF} + \frac{V_L}{L} \cdot t_{L_LIM_DELAY}$$

where

- I_{LIMF} is the static current limit, specified in [Electrical Characteristics](#)
- L is the inductance
- V_L is the voltage across the inductor ($V_{IN} - V_{OUT}$)
- $t_{L_LIM_DELAY}$ is the internal propagation delay (1)

In forced PWM mode, a negative current limit (I_{LIMN}) is enabled to prevent excessive current flowing backwards to the input. When the inductor current reaches I_{LIMN} , the low-side MOSFET turns off and the high-side MOSFET turns on and kept on until TON time expires.

8.3.7 Output Voltage Discharge

The purpose of the output discharge function is to ensure a defined ramp-down of the output voltage when the device is disabled.

The internal discharge resistor is connected to the VOS pin. The discharge function is enabled as soon as the device is disabled or if UVLO is entered. It is not active during Thermal Shutdown. The discharge circuit remains active as long as the input voltage is above 0.7 V.

8.3.8 Thermal Shutdown

The junction temperature (T_J) of the device is monitored by an internal temperature sensor. The device enters thermal shutdown when the junction temperature exceeds the thermal shutdown threshold (T_{SD}) of 160°C (typ.). Both the high-side and low-side MOSFETs are turned off. The device resumes its operation when the junction temperature falls below typically 155°C again and begins with a soft-start cycle without reading R_{SET} again. In Power-Save Mode, the thermal shutdown feature is disabled.

8.3.9 STOP Mode

The TPS6284x includes the STOP input pin, allowing the user to temporarily stop the switching of the regulator. The STOP pin function does not depend on the setting of the MODE pin. The STOP pin is only present on the DLC package.

When a logic high level is applied to the STOP pin, the regulator is forced to stop switching after the current switching cycle. The application is powered by the charge available in the output capacitor. No switching noise is generated, which can be beneficial in noise-sensitive sampled applications.

An MCU controlling this pin needs to take care to turn the device back on before the output voltage reaches a system critical level. Should this not happen, the output voltage is clamped to about 0.5 V below the set output voltage. In STOP mode, the device consumes typically 70 μ A operating quiescent current from the input supply.

When a logic low level is applied to the STOP pin, the regulator immediately resumes switching operation without a start-up delay or soft start. To avoid a floating input, an internal 450-k Ω resistor pulls the STOP pin to GND. A control circuit disconnects the pull-down resistor at the STOP pin once a high level has been detected (similar to the EN pin).

8.4 Device Functional Modes

8.4.1 Power-Save Mode Operation

The DCS-Control topology supports Power-Save Mode operation. At light loads, the device operates in PFM (Pulse Frequency Modulation) mode that generates a single switching pulse to ramp up the inductor current and recharge the output capacitor, followed by a sleep period where most of the internal circuits are shutdown to achieve lowest operating quiescent current. During this time, the load current is supported by the output capacitor. The duration of the sleep period depends on the load current and the inductor peak current. During the sleep periods, the current consumption is reduced to typically 60 nA. This low quiescent current consumption is achieved by an ultra-low power reference, an integrated high-impedance feedback divider network, and an optimized Power-Save Mode operation. To achieve a stable switching frequency in steady state operation, the on-time is calculated as in [Equation 2](#).

$$T_{ON} = \frac{V_{OUT}}{V_{IN}} \cdot 556\text{ns} \quad (2)$$

In PFM Mode, the switching frequency varies linearly with the load current and is calculated in [Equation 3](#). At medium and high load conditions, the device enters automatically PWM (Pulse Width Modulation) mode and operates in continuous conduction mode with a nominal switching frequency (f_{sw}). The switching frequency in PWM mode is controlled and depends on V_{IN} and V_{OUT} . The boundary between PWM and PFM mode is when the inductor current becomes discontinuous.

$$f_{PFM} = \frac{2 \cdot I_{OUT}}{T_{ON}^2 \cdot \frac{V_{IN}}{V_{OUT}} \left[\frac{V_{IN} - V_{OUT}}{L} \right]} \quad (3)$$

If the load current decreases, the converter seamlessly enters PFM mode to maintain high efficiency down to ultra-light loads. Since DCS-Control supports both operation modes within one single building block, the transition from PWM to PFM modes is seamless with minimum output voltage ripple.

8.4.2 Forced PWM Mode Operation

With a high level on the MODE input, the device enters forced PWM Mode and operates with a high switching frequency over the entire load range, even at very light loads. This reduces or eliminates interference with RF and noise-sensitive circuits, but reduces efficiency at light loads. The MODE pin can be changed during operation and must be terminated.

8.4.3 100% Mode Operation

In PWM mode, the duty-cycle of a buck converter is given as $D = V_{OUT}/V_{IN}$. The duty-cycle increases as the input voltage comes closer to the output voltage. Once the input voltage decreases to near 100% duty cycle, the output voltage set point is increased by +30 mV. As the input voltage decreases further, the device enters 100% duty-cycle mode and keeps the high-side MOSFET on continuously. The output (V_{OUT}) is connected to the input (V_{IN}) through the inductor and the internal high-side MOSFET. The minimum input voltage to maintain a given output voltage depends on the load current and is calculated as:

$$V_{INmin} = V_{OUT} + I_{OUT} \times (R_{DS(on)max} + R_L)$$

where

- I_{OUT} = output current
- $R_{DS(on)max}$ = maximum P-channel switch $R_{DS(on)}$
- R_L = DC resistance of the inductor

The TPS6284x contains special circuitry to keep an ultra-low I_Q of 120 nA during 100% mode operation.

9 Application and Implementation

NOTE

Information in the following applications sections is not part of the TI component specification, and TI does not warrant its accuracy or completeness. TI's customers are responsible for determining suitability of components for their purposes. Customers should validate and test their design implementation to confirm system functionality.

9.1 Application Information

The following section discusses the design of the external components to complete the power supply design for several input and output voltage options by using typical applications as a reference.

9.2 Typical Application

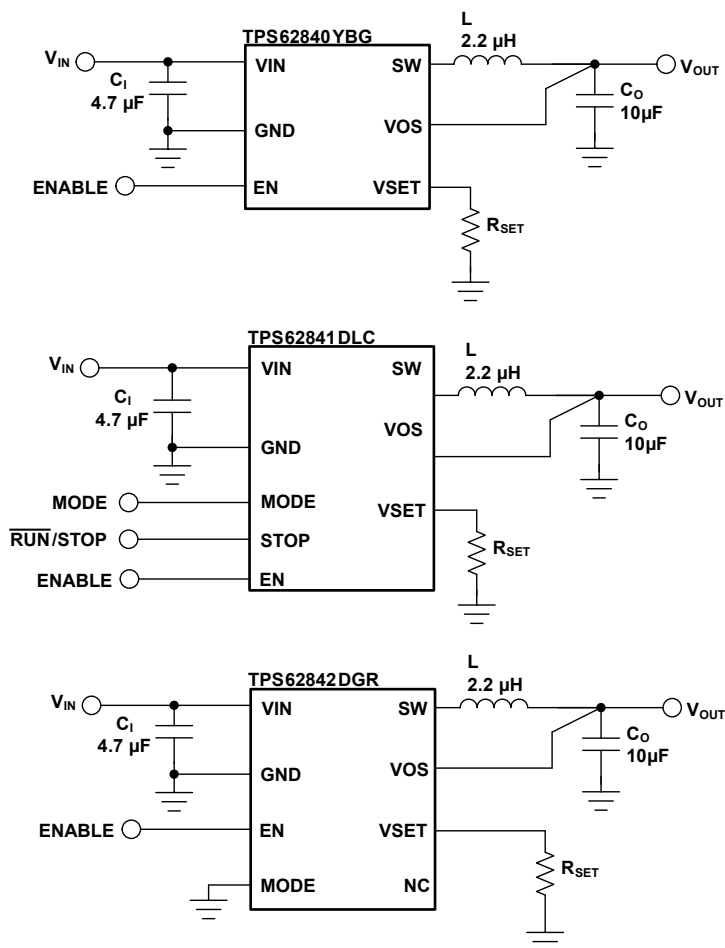

Figure 13. TPS6284x Application Circuit

Additional circuits are shown in the [System Examples](#).

9.2.1 Design Requirements

Table 2 shows the list of components for the application circuit and the characteristic application curves.

Typical Application (continued)

Table 2. Components for Application Characteristic Curves

REFERENCE	DESCRIPTION	VALUE	SIZE [L x W x T]	MANUFACTURER ⁽¹⁾
IC	TPS6284x step-down converter			TI
C _I	GRM155R61A475MEAAD ceramic capacitor	4.7 μF / 10 V / X5R	(0402) [1 mm x 0.5 mm x 0.65 mm max.]	muRata
C _O	GRM155R60G106ME44D ceramic capacitor	10 μF / 4 V / X5R	(0402) [1 mm x 0.5 mm x 0.65 mm max.]	muRata
L	DFE201612E-2R2M=P2 inductor	2.2 μH / 116 mΩ DCR	(2016) [2.0 mm x 1.6 mm x 1.2 mm max.]	muRata
R _{SET}	Resistor E96 series 1%, TC ±200ppm	See Table 1		

(1) See the [Third-party Products Disclaimer](#).

9.2.2 Detailed Design Procedure

The inductor and output capacitor together provide a low-pass filter. To simplify this process, [Table 3](#) outlines possible inductor and capacitor value combinations.

Table 3. Recommended LC Output Filter Combinations

INDUCTOR VALUE [μH] ⁽¹⁾	OUTPUT CAPACITOR VALUE [μF] ⁽²⁾	
	10 μF	22 μF
2.2	√ ⁽³⁾	√

(1) Inductor tolerance and current de-rating is anticipated. The effective inductance can vary by 20% and -20%.

(2) Capacitance tolerance and bias voltage de-rating is anticipated. The effective capacitance varies by +20% and -50%.

(3) Typical application configuration. Other check marks indicate alternative filter combinations.

9.2.2.1 Inductor Selection

The inductor value affects the peak-to-peak ripple current, PWM-to-PFM transition point, output voltage ripple, and efficiency. The selected inductor has to be rated for its DC resistance and saturation current. The inductor ripple current (ΔI_L) decreases with higher inductance and increases with higher V_{IN} or V_{OUT} and can be estimated according to [Equation 4](#).

[Equation 5](#) calculates the maximum inductor current under static load conditions. The saturation current of the inductor must be rated higher than the maximum inductor current, as calculated with [Equation 5](#). This is recommended because during a heavy load transient the inductor current rises above the calculated value. A more conservative way is to select the inductor saturation current according to the high-side MOSFET switch current limit, I_{LIMF} .

$$\Delta I_L = V_{out} \times \frac{1 - \frac{V_{out}}{V_{in}}}{L \times f} \quad (4)$$

$$I_{Lmax} = I_{outmax} + \frac{\Delta I_L}{2}$$

where

- f is the switching frequency
- L is the inductance
- ΔI_L is the peak-to-peak inductor ripple current
- I_{Lmax} is the maximum inductor current

(5)

[Table 4](#) shows a list of possible inductors.

Table 4. List of Possible Inductors⁽¹⁾

INDUCTANCE [μH]	INDUCTOR TYPE	SIZE [L x W x T]	SUPPLIER
2.2	DFE201612E	[2.0 mm x 1.6 mm x 1.2 mm max.]	muRata
2.2	DFE201210S	[2.0 mm x 1.2 mm x 1.0 mm max.]	muRata

(1) See the [Third-party Products Disclaimer](#).

9.2.2.2 Output Capacitor Selection

The DCS-Control scheme of the TPS62840 allows the use of tiny ceramic capacitors. Ceramic capacitors with low-ESR values have the lowest output voltage ripple and are recommended. The output capacitor requires either an X7R or X5R dielectric.

At light load currents, the converter operates in Power-Save Mode and the output voltage ripple is dependent on the output capacitor value. Larger output capacitors reduce the output voltage ripple. The leakage current of the output capacitor adds to the overall quiescent current.

Table 5. List of Possible Capacitors⁽¹⁾

CAPACITOR VALUE [μF]	CAPACITOR TYPE	SIZE IMPERIAL (METRIC)	SIZE [L x W x T]	SUPPLIER
10	GRM155R60G106ME44D	0402 (1005)	[1mm x 0.5mm x 0.65mm max.]	muRata

(1) See the [Third-party Products Disclaimer](#).

9.2.2.3 Input Capacitor Selection

Because the buck converter has a pulsating input current, a low-ESR input capacitor is required for best input voltage filtering to minimize input voltage spikes. For most applications, a 4.7-μF input capacitor is sufficient.

When operating from a high impedance source, a larger input buffer capacitor is recommended to avoid voltage drops during start-up and load transients.

The input capacitor can be increased without any limit for better input voltage filtering. The leakage current of the input capacitor adds to the overall quiescent current. [Table 6](#) shows a selection of input and output capacitors.

Table 6. List of Possible Capacitors⁽¹⁾

CAPACITOR VALUE [μF]	CAPACITOR TYPE	SIZE IMPERIAL (METRIC)	SIZE [L x W x T]	SUPPLIER
4.7	GRM155R61A475MEAAD	0402 (1005)	[1mm x 0.5mm x 0.65mm max.]	muRata
4.7	GRM31CR71H475MA12L	1206 (3216)	[3.2mm x 1.6mm x 1.8mm max.]	muRata
4.7	C1608X7S1A475M080AC	0603 (1608)	[1.6mm x 0.8mm x 1.0mm max.]	TDK
10	GRM155R60J106ME15D	0402 (1005)	[1mm x 0.5mm x 0.65mm max.]	muRata

(1) See the [Third-party Products Disclaimer](#).

9.2.3 Application Curves

The conditions for the following application curves are $V_{IN} = 3.6\text{ V}$, $V_{OUT} = 1.8\text{ V}$, MODE = GND, STOP = GND, and the used components listed in Table 2, unless otherwise noted.

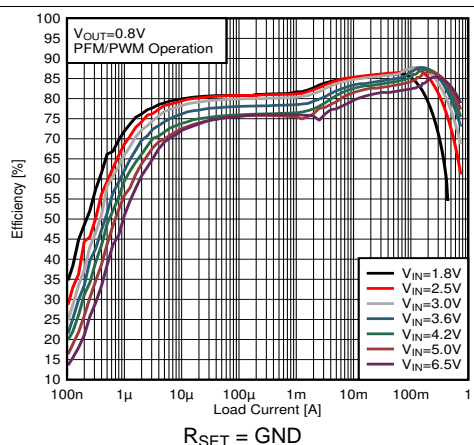

Figure 14. Efficiency Power Save Mode $V_{OUT} = 0.8\text{ V}$

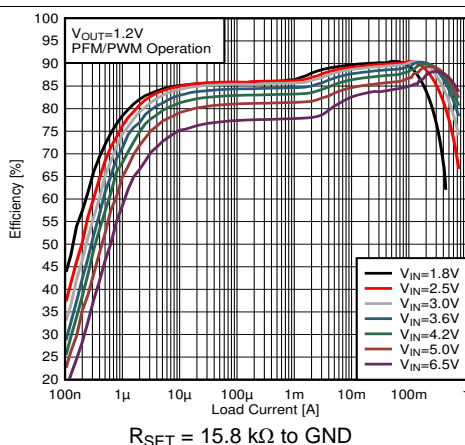

Figure 15. Efficiency Power Save Mode $V_{OUT} = 1.2\text{ V}$

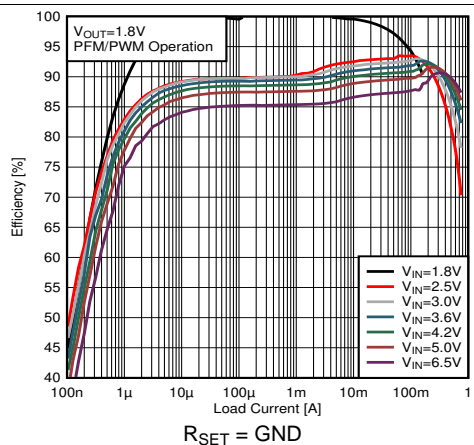

Figure 16. Efficiency Power Save Mode $V_{OUT} = 1.8\text{ V}$

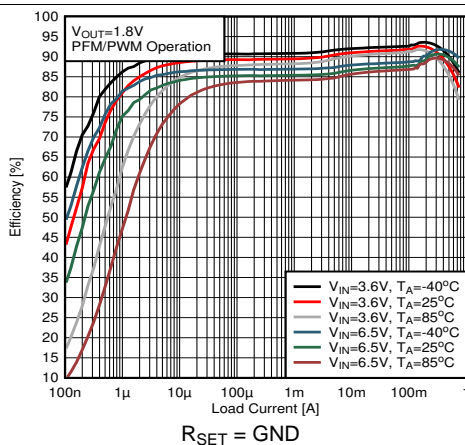

Figure 17. Efficiency Power Save Mode $V_{OUT} = 1.8\text{ V}$

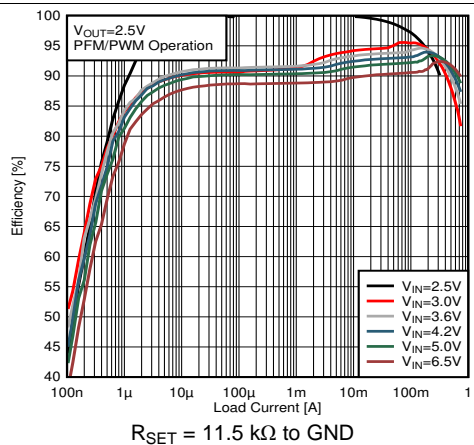

Figure 18. Efficiency Power Save Mode $V_{OUT} = 2.5\text{ V}$

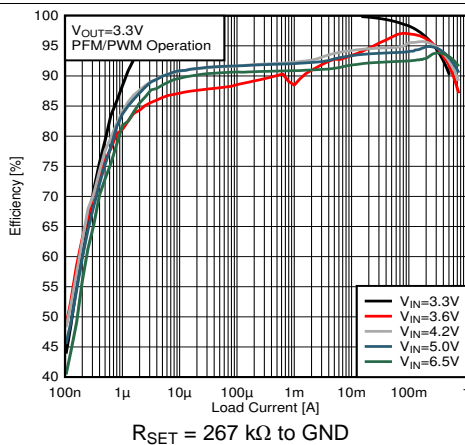

Figure 19. Efficiency Power Save Mode $V_{OUT} = 3.3\text{ V}$

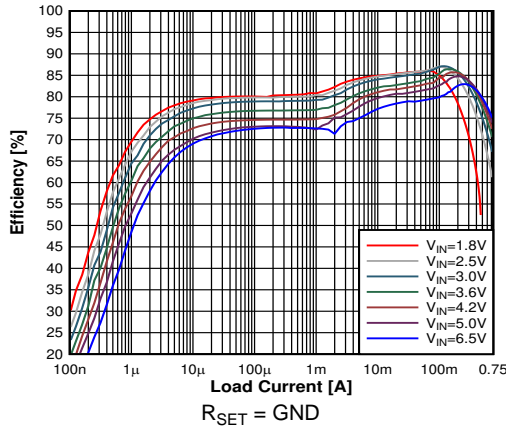

Figure 20. Efficiency Power Save Mode $V_{OUT} = 0.8\text{ V}$ for the DGR device

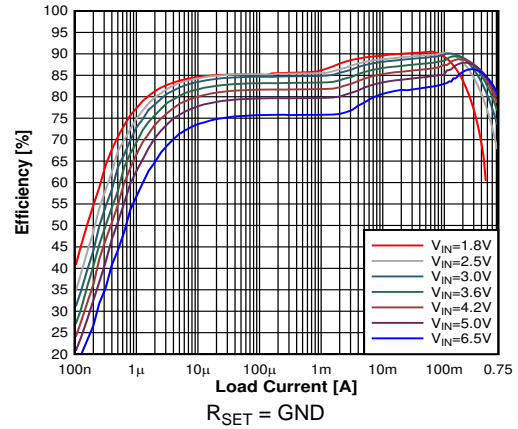

Figure 21. Efficiency Power Save Mode $V_{OUT} = 1.2\text{ V}$ for the DGR device

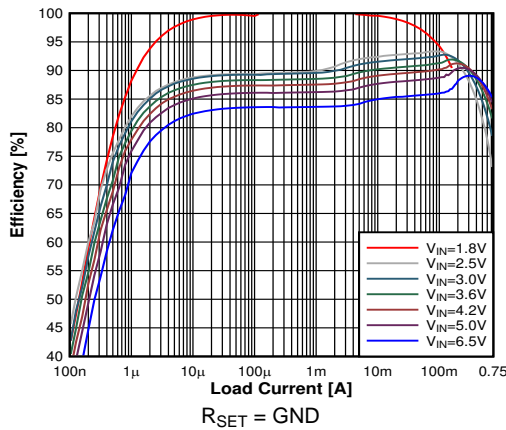

Figure 22. Efficiency Power Save Mode $V_{OUT} = 1.8\text{ V}$ for the DGR device

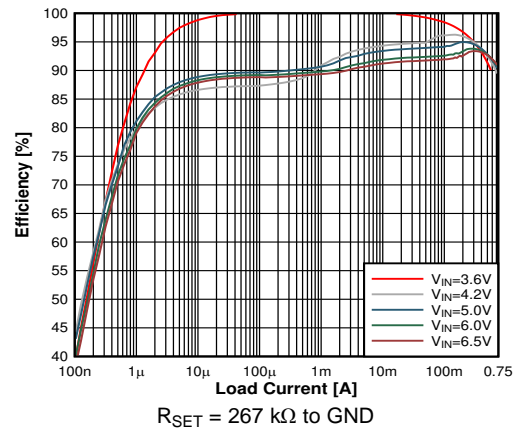

Figure 23. Efficiency Power Save Mode $V_{OUT} = 3.6\text{ V}$ for the DGR device

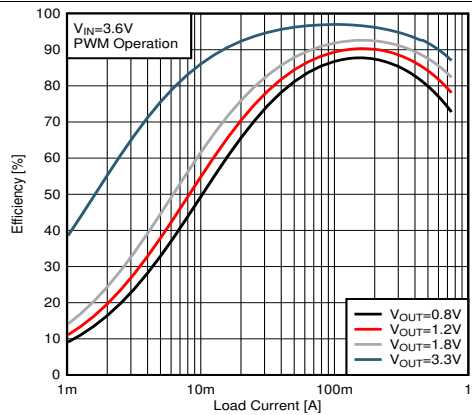

Figure 24. Efficiency Forced PWM Mode $V_{OUT} = 0.8\text{ V} / 1.2\text{ V} / 1.8\text{ V} / 3.3\text{ V}$

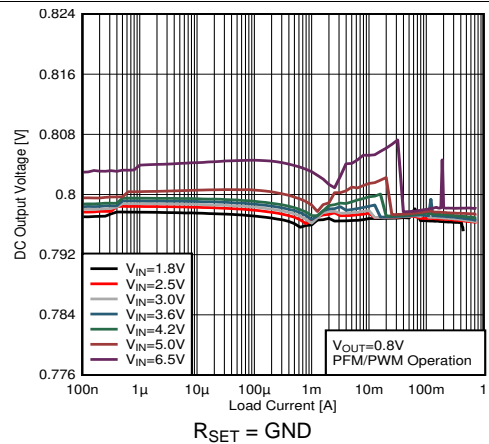
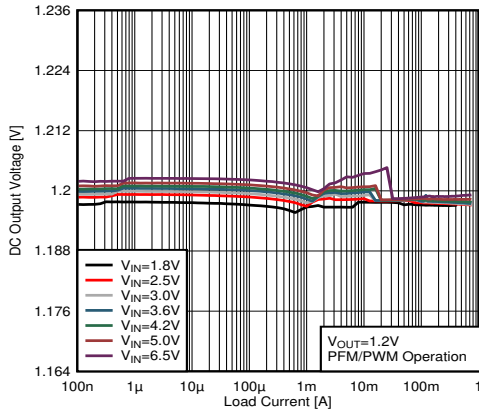
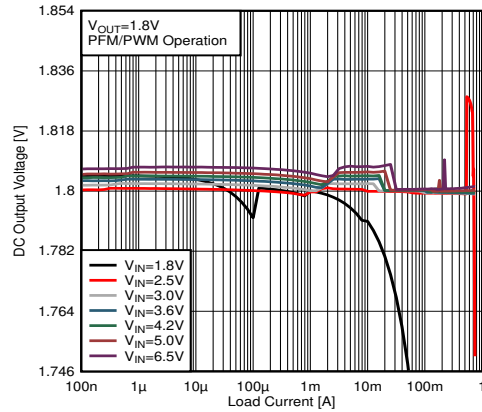

Figure 25. Output Voltage versus Load Current $V_{OUT} = 0.8\text{ V}$



$R_{SET} = 15.8k \Omega$ to GND

Figure 26. Output Voltage versus Load Current
 $V_{OUT} = 1.2 V$



$R_{SET} = GND$

Figure 27. Output Voltage versus Load Current
 $V_{OUT} = 1.8 V$

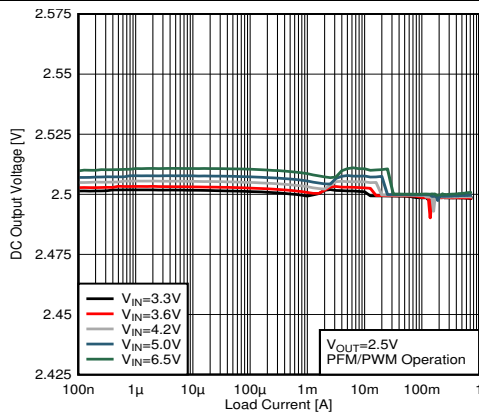

$R_{SET} = 11.5k \Omega$ to GND

Figure 28. Output Voltage versus Load Current
 $V_{OUT} = 2.5 V$

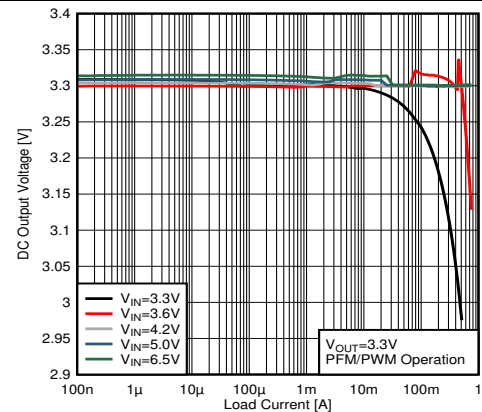

$R_{SET} = 267k \Omega$ to GND

Figure 29. Output Voltage versus Load Current
 $V_{OUT} = 3.3 V$

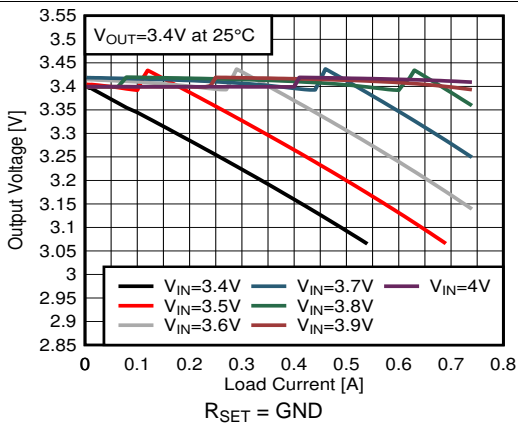

$R_{SET} = GND$

Figure 30. Output Voltage versus Load Current
 $V_{OUT} = 3.4 V$

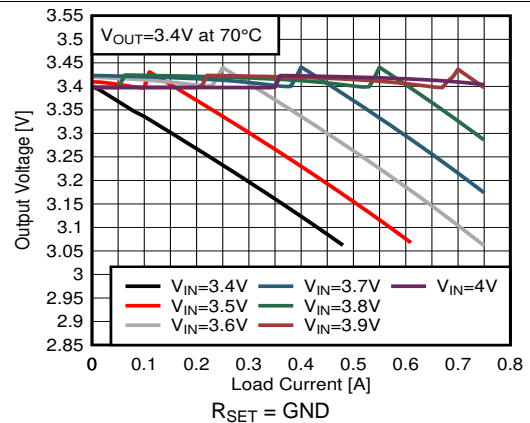

$R_{SET} = GND$

Figure 31. Output Voltage versus Load Current
 $V_{OUT} = 3.4 V$

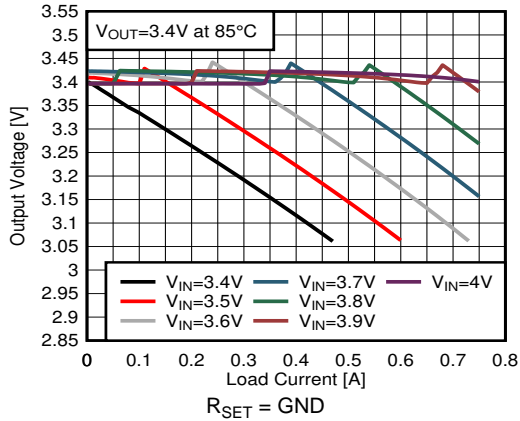

Figure 32. Output Voltage versus Load Current
V_{OUT} = 3.4 V

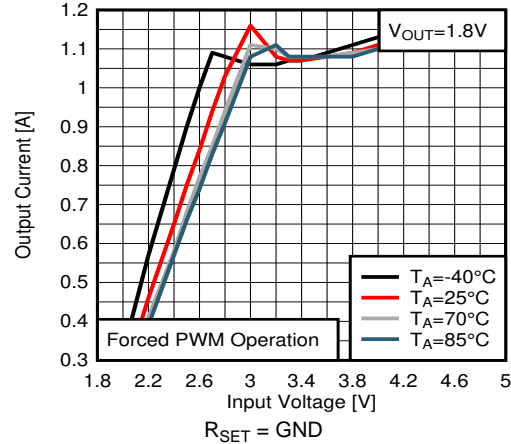

Figure 33. Maximum Output Current versus Input Voltage
V_{OUT} = 1.8 V

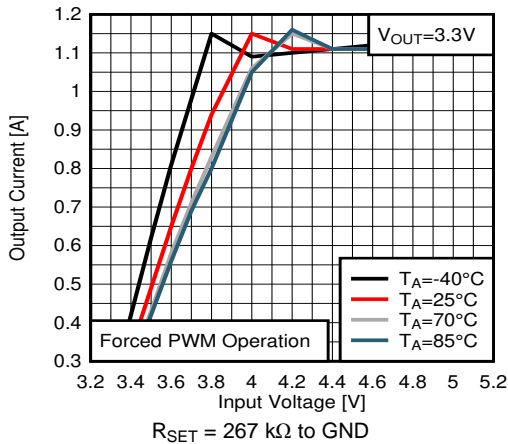

Figure 34. Maximum Output Current versus Input Voltage
V_{OUT} = 3.3 V

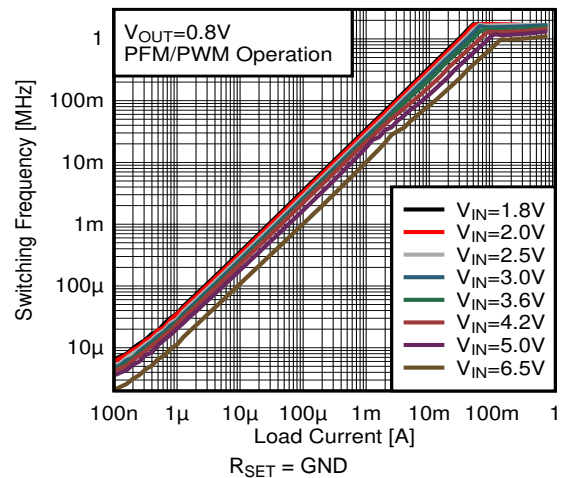

Figure 35. Switching Frequency versus Load Current
V_{OUT} = 0.8 V

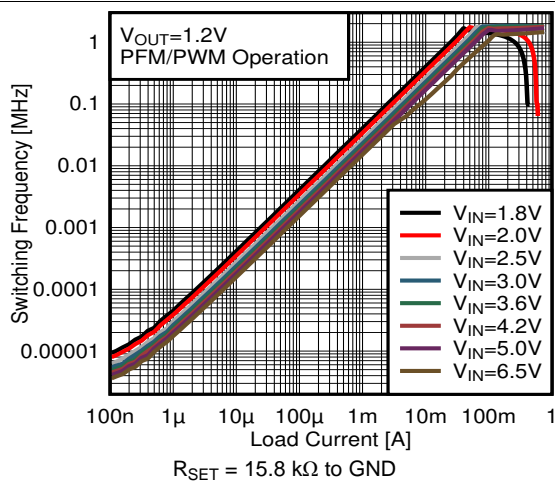

Figure 36. Switching Frequency versus Load Current
V_{OUT} = 1.2 V

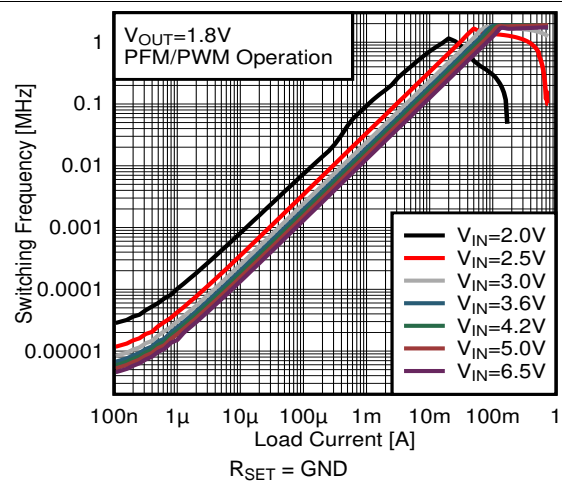

Figure 37. Switching Frequency versus Load Current
V_{OUT} = 1.8 V

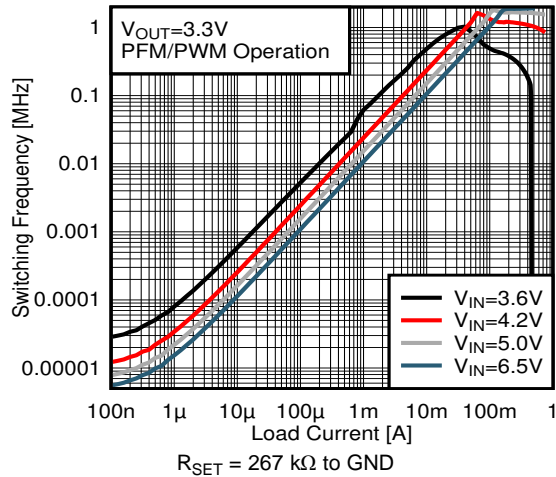

Figure 38. Switching Frequency versus Load Current
V_{OUT} = 3.3 V

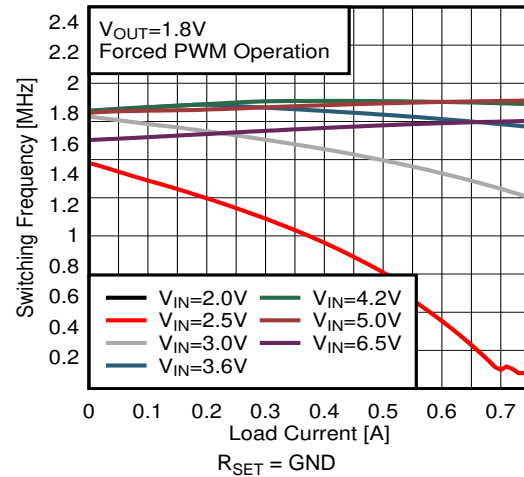

Figure 39. Switching Frequency versus Load Current
V_{OUT} = 1.8 V

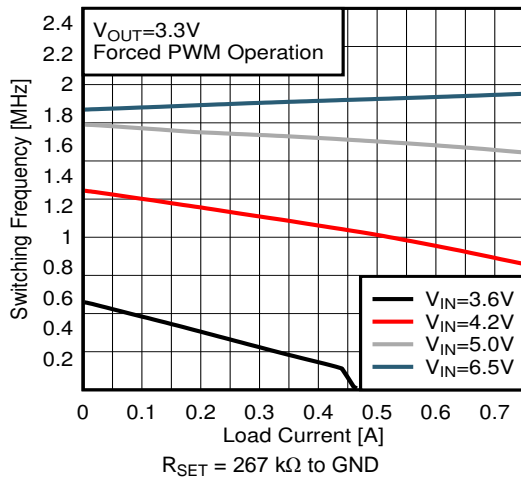

Figure 40. Switching Frequency versus Load Current
V_{OUT} = 3.3 V

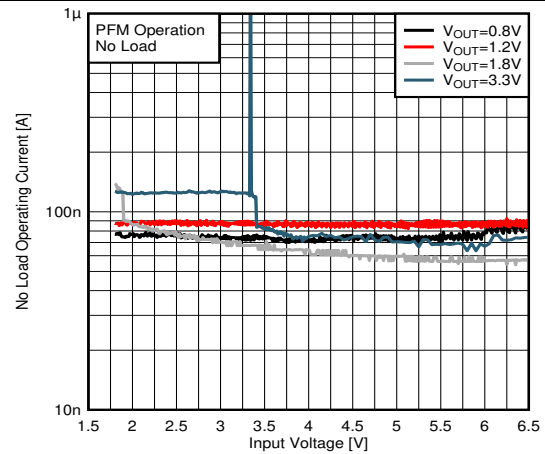

Figure 41. No Load Operating Current versus Input Voltage

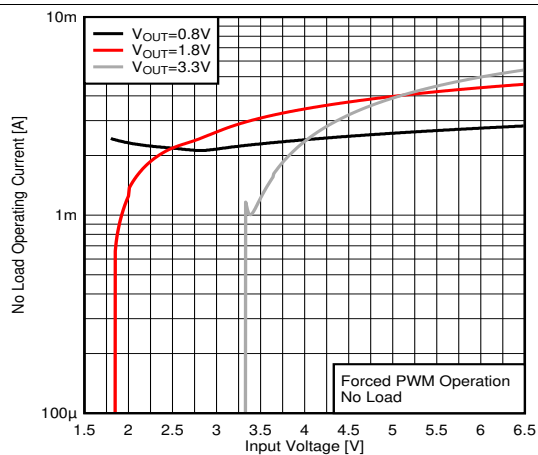
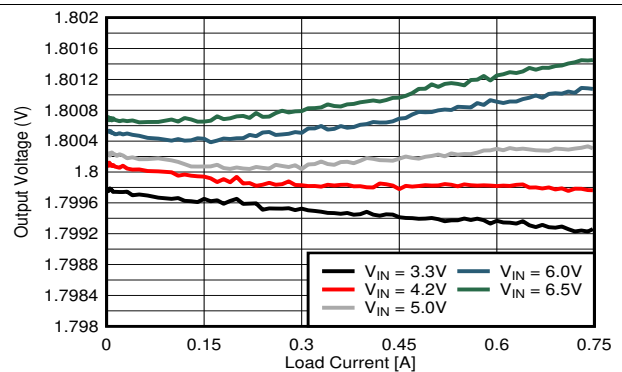
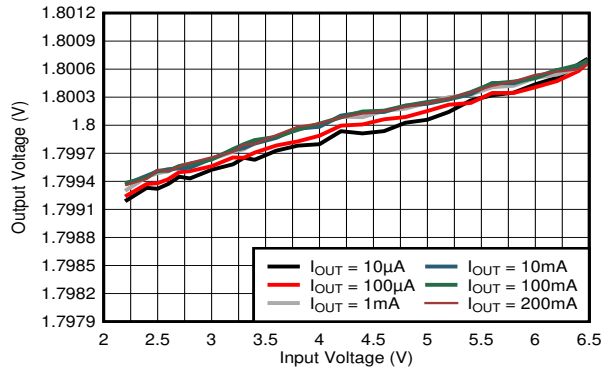

Figure 42. No Load Operating Current versus Input Voltage



EN = VIN MODE = HIGH

Figure 43. Output Voltage Accuracy (Load Regulation)



EN = VIN MODE = HIGH

Figure 44. Output Voltage Accuracy (Line Regulation)

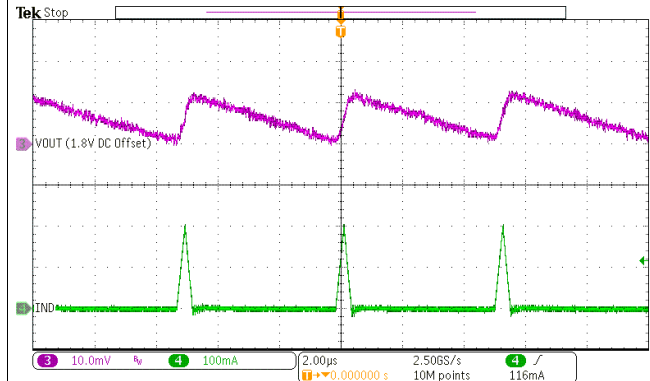

V_{OUT} = 1.8 V I_{OUT} = 10 mA

Figure 45. Output Voltage Ripple, PFM Operation

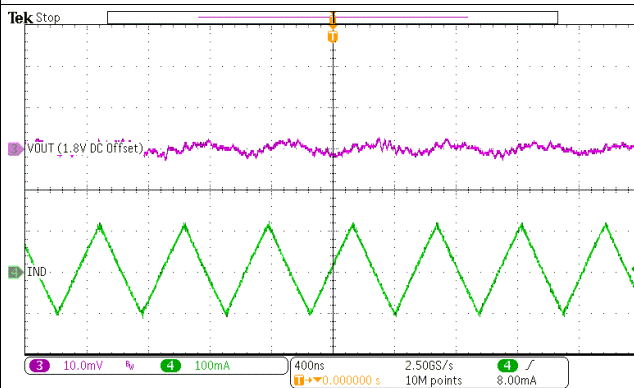

V_{OUT} = 1.8 V I_{OUT} = 10 mA
MODE = HIGH

Figure 46. Output Voltage Ripple, PWM Operation

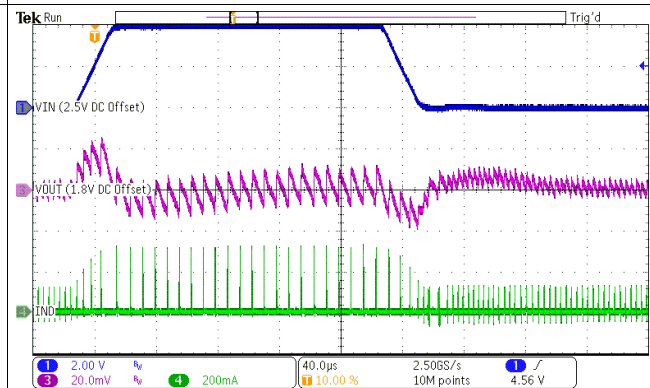

V_{OUT} = 1.8 V V_{IN} = 2.5 V to 6.5 V
rise/fall time = 20 µs I_{OUT} = 10 mA

Figure 47. Line Transient PFM Mode

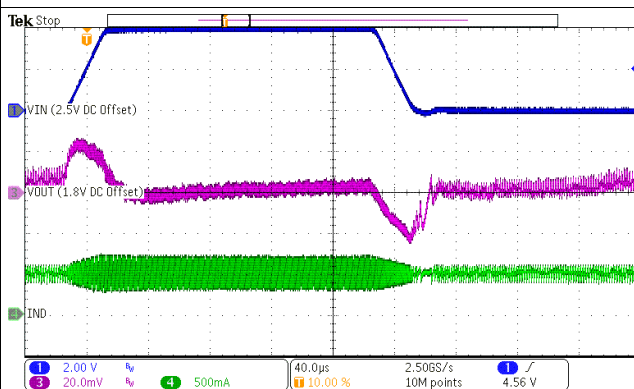

V_{OUT} = 1.8 V V_{IN} = 2.5 V to 6.5 V
rise/fall time = 20 µs I_{OUT} = 500 mA

Figure 48. Line Transient PWM Mode

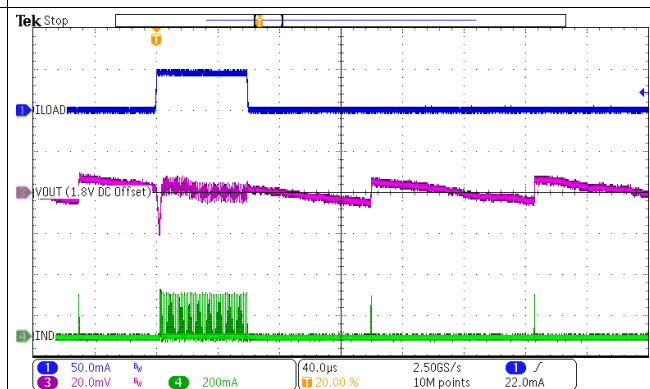

V_{OUT} = 1.8 V V_{IN} = 3.6 V
rise/fall time < 1 µs I_{OUT} = 125 µA to 50 mA

Figure 49. Load Transient PFM Mode

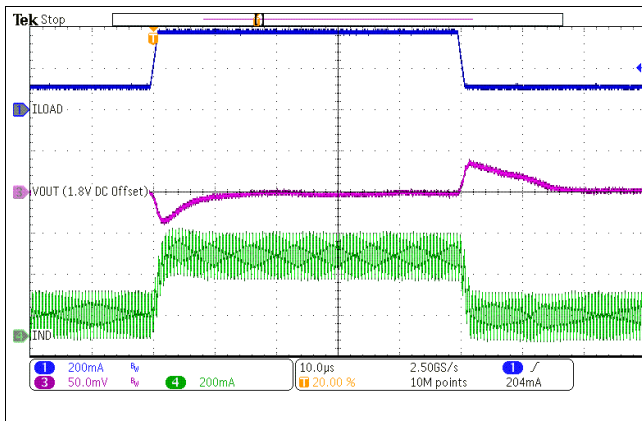

$V_{OUT} = 1.8\text{ V}$
rise/fall time < 1 μs $V_{IN} = 3.6\text{ V}$
 $I_{OUT} = 125\text{ mA to }375\text{ mA}$

Figure 50. Load Transient PFM/PWM Mode

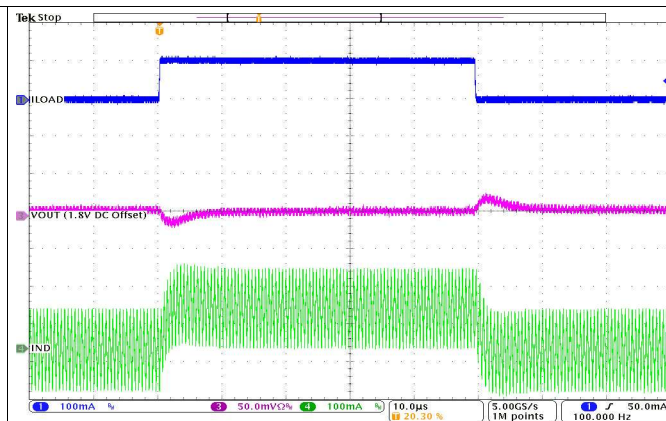

$V_{OUT} = 1.8\text{ V}$
rise/fall time < 1 μs $V_{IN} = 3.6\text{ V}$
 $I_{OUT} = 0\text{ A to }100\text{ mA}$

Figure 51. Load Transient PWM Mode from No Load

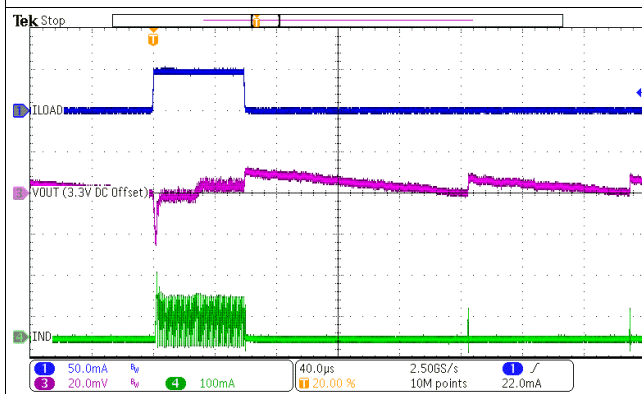

$V_{OUT} = 3.3\text{ V}$
rise/fall time < 1 μs $V_{IN} = 3.6\text{ V}$
 $I_{OUT} = 75\text{ }\mu\text{A to }50\text{ mA}$

Figure 52. Load Transient PFM Mode

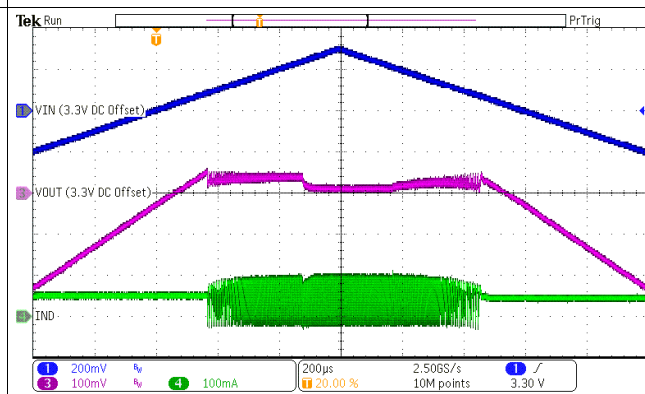

$V_{OUT} = 3.3\text{ V}$ $V_{IN} = 3.1\text{ V to }3.6\text{ V}$
 $I_{OUT} = 50\text{ mA}$

Figure 53. 100% Mode Entry/Exit Operation

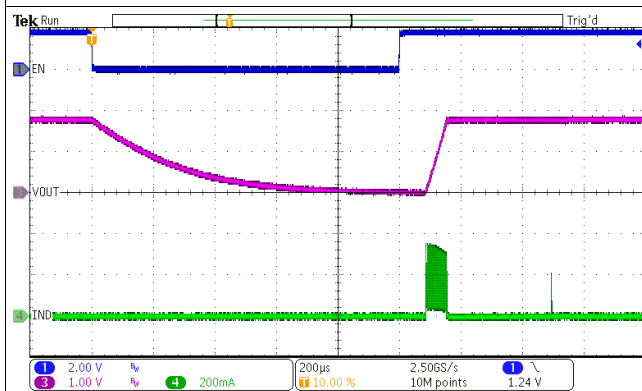

$V_{OUT} = 1.8\text{ V}$
Turned on by EN input $V_{IN} = 3.6\text{ V}$
 $I_{OUT} = 0\text{ mA}$

Figure 54. Start-up/Shutdown into No Load

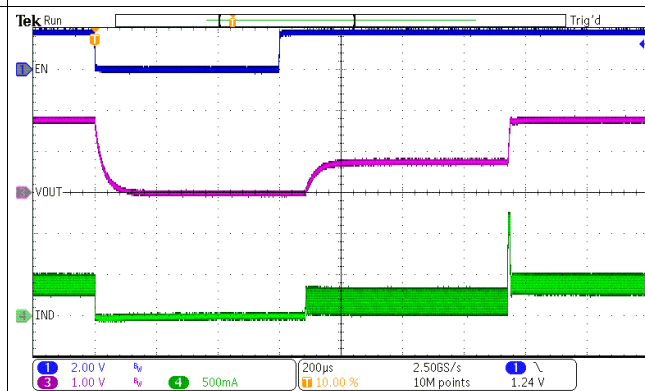

$V_{OUT} = 1.8\text{ V}$
Turned on by EN input $V_{IN} = 3.6\text{ V}$
 $I_{OUT} = 400\text{ mA}$
 $R_{LOAD} = 4.5\text{ }\Omega$

Figure 55. Start-up/Shutdown into Load

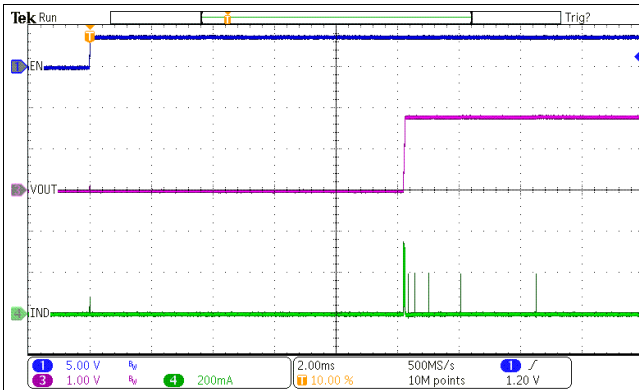

$V_{OUT} = 1.8\text{ V}$
 V_{IN} rising from 0 V to 3.6 V

$EN = V_{IN}$
 $I_{OUT} = 0\text{ mA}$

Figure 56. Start-up/Shutdown into No Load

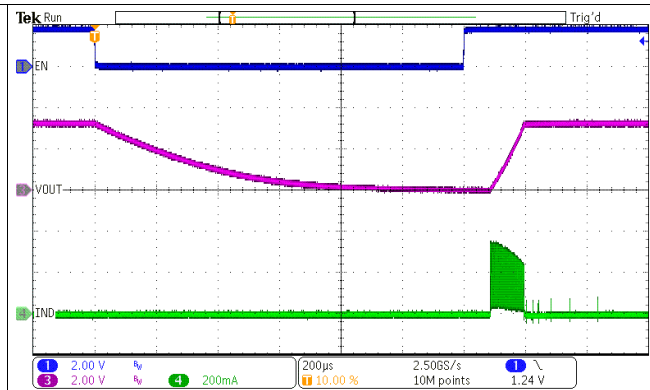

$V_{OUT} = 3.3\text{ V}$
 Turned on by EN input

$V_{IN} = 3.6\text{ V}$
 $I_{OUT} = 0\text{ mA}$

Figure 57. Start-up/Shutdown into No Load

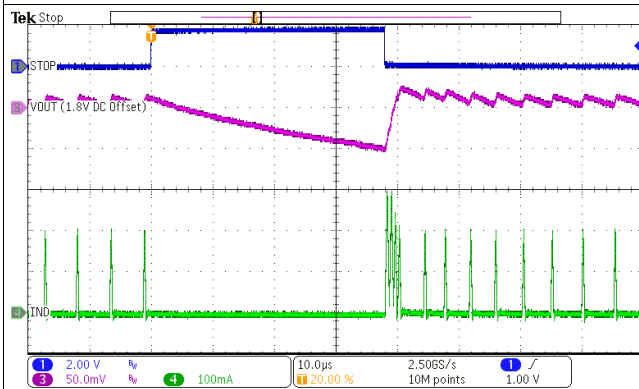

$V_{OUT} = 1.8\text{ V}$
 PFM Operation

$V_{IN} = 3.6\text{ V}$
 $I_{OUT} = 10\text{ mA}$

Figure 58. STOP Mode Operation

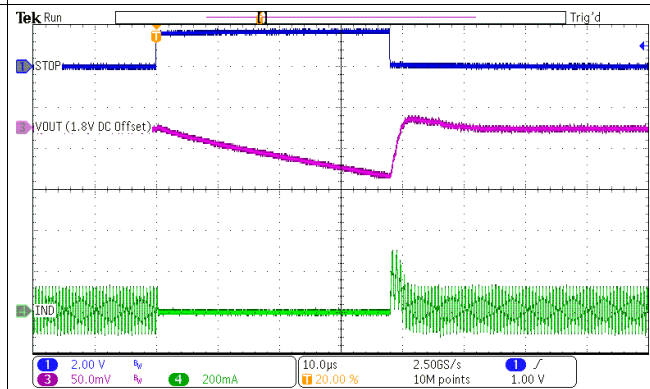

$V_{OUT} = 1.8\text{ V}$
 PWM Operation

$V_{IN} = 3.6\text{ V}$
 $I_{OUT} = 10\text{ mA}$

Figure 59. STOP Mode Operation

9.3 System Example

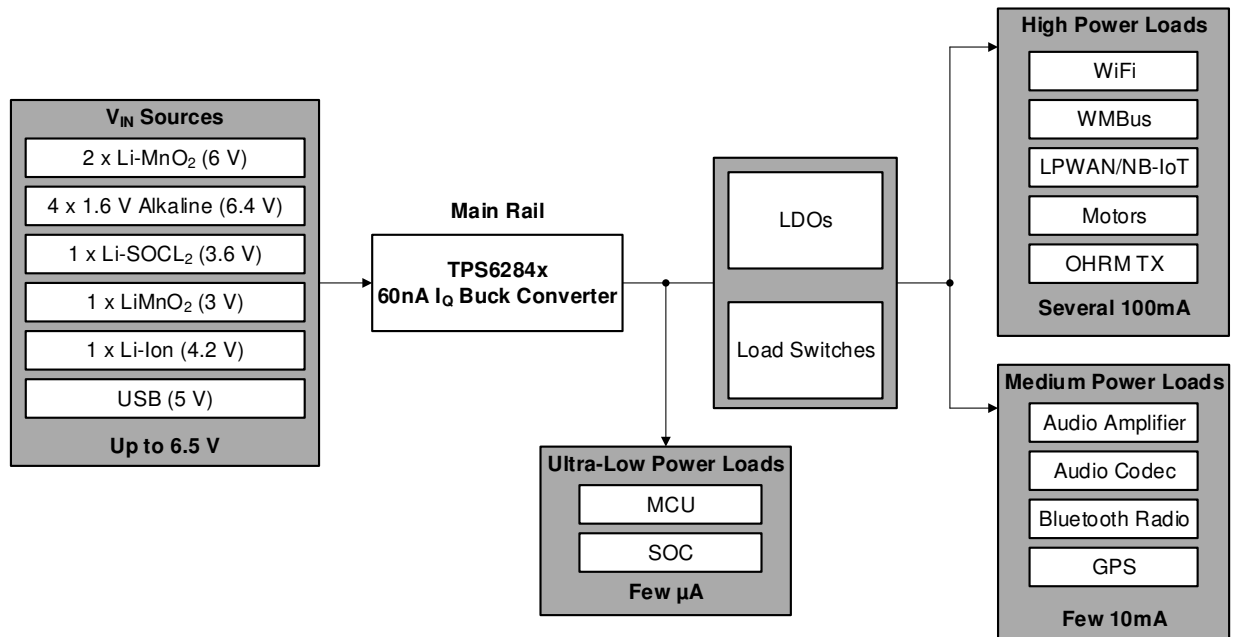

Figure 60. The Broad Range of Input Voltage Sources and Various Power Loads that TPS6284x Can Support

10 Power Supply Recommendations

The power supply must provide a current rating according to the supply voltage, output voltage, and output current of the TPS62840.

11 Layout

11.1 Layout Guidelines

The TPS62840 pinout has been optimized to enable a single layer PCB routing of the device and its critical passive components such as C_{IN} , C_{OUT} , and L .

- As for all switching power supplies, the layout is an important step in the design. Care must be taken in board layout to get the specified performance.
- It is critical to provide a low inductance, low impedance ground path. Therefore, use wide and short traces for the main current paths.
- The input capacitor must be placed as close as possible to the V_{IN} and GND pins of the device. This is the most critical component placement.
- The VOS line is a sensitive, high impedance line and must be connected to the output capacitor and routed away from noisy components and traces (for example, the SW line) or other noise sources.

11.2 Layout Example

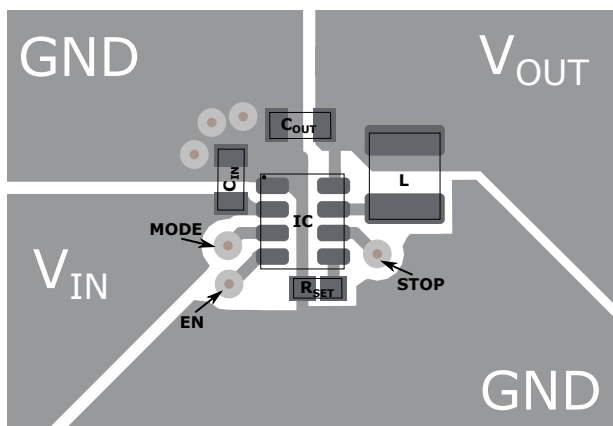

**Figure 61. Recommended PCB Layout
DLC Package**

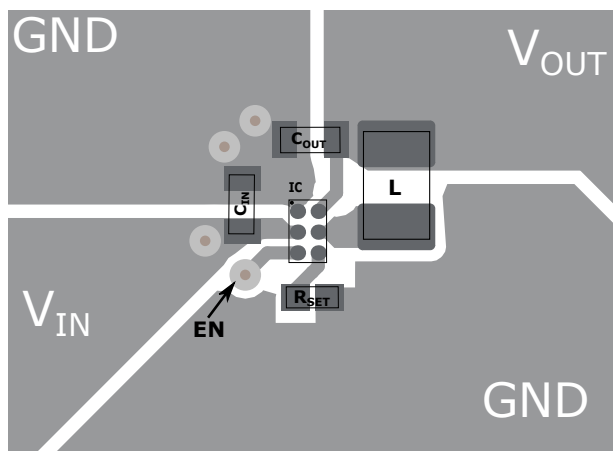

**Figure 62. Recommended PCB Layout
YBG Package**

Layout Example (continued)

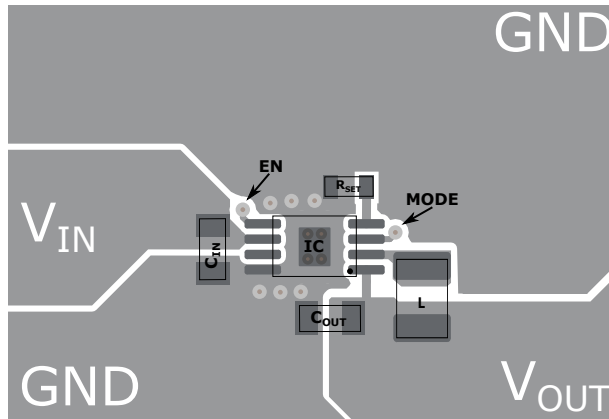

Figure 63. Recommended PCB Layout
DGR Package

12 Device and Documentation Support

12.1 Device Support

12.1.1 Third-Party Products Disclaimer

TI'S PUBLICATION OF INFORMATION REGARDING THIRD-PARTY PRODUCTS OR SERVICES DOES NOT CONSTITUTE AN ENDORSEMENT REGARDING THE SUITABILITY OF SUCH PRODUCTS OR SERVICES OR A WARRANTY, REPRESENTATION OR ENDORSEMENT OF SUCH PRODUCTS OR SERVICES, EITHER ALONE OR IN COMBINATION WITH ANY TI PRODUCT OR SERVICE.

12.2 Support Resources

TI E2E™ support forums are an engineer's go-to source for fast, verified answers and design help — straight from the experts. Search existing answers or ask your own question to get the quick design help you need.

Linked content is provided "AS IS" by the respective contributors. They do not constitute TI specifications and do not necessarily reflect TI's views; see TI's [Terms of Use](#).

12.3 Trademarks

DCS-Control, E2E are trademarks of Texas Instruments.
All other trademarks are the property of their respective owners.

12.4 Electrostatic Discharge Caution



These devices have limited built-in ESD protection. The leads should be shorted together or the device placed in conductive foam during storage or handling to prevent electrostatic damage to the MOS gates.

12.5 Glossary

[SLYZ022](#) — *TI Glossary*.

This glossary lists and explains terms, acronyms, and definitions.

13 Mechanical, Packaging, and Orderable Information

The following pages include mechanical, packaging, and orderable information. This information is the most current data available for the designated devices. This data is subject to change without notice and revision of this document. For browser-based versions of this data sheet, refer to the left-hand navigation.

PACKAGING INFORMATION

Orderable Device	Status (1)	Package Type	Package Drawing	Pins	Package Qty	Eco Plan (2)	Lead finish/ Ball material (6)	MSL Peak Temp (3)	Op Temp (°C)	Device Marking (4/5)	Samples
TPS62840DLCR	ACTIVE	VSON-HR	DLC	8	3000	RoHS & Green	Call TI NIPDAU	Level-1-260C-UNLIM	-40 to 125	E5	Samples
TPS62840YBGR	ACTIVE	DSBGA	YBG	6	3000	RoHS & Green	SNAGCU	Level-1-260C-UNLIM	-40 to 125	62840	Samples
TPS62841DGRR	ACTIVE	HVSSOP	DGR	8	2500	RoHS & Green	NIPDAU	Level-1-260C-UNLIM	-40 to 125	T841R	Samples
TPS62841DLCR	ACTIVE	VSON-HR	DLC	8	3000	RoHS & Green	Call TI NIPDAU	Level-1-260C-UNLIM	-40 to 125	E9	Samples
TPS62841YBGR	ACTIVE	DSBGA	YBG	6	3000	RoHS & Green	SNAGCU	Level-1-260C-UNLIM	-40 to 125	62841	Samples
TPS62842DGRR	ACTIVE	HVSSOP	DGR	8	2500	RoHS & Green	NIPDAU	Level-1-260C-UNLIM	-40 to 125	T842R	Samples
TPS62849DLCR	ACTIVE	VSON-HR	DLC	8	3000	RoHS & Green	NIPDAU	Level-1-260C-UNLIM	-40 to 125	FF	Samples

(1) The marketing status values are defined as follows:

ACTIVE: Product device recommended for new designs.

LIFEBUY: TI has announced that the device will be discontinued, and a lifetime-buy period is in effect.

NRND: Not recommended for new designs. Device is in production to support existing customers, but TI does not recommend using this part in a new design.

PREVIEW: Device has been announced but is not in production. Samples may or may not be available.

OBSOLETE: TI has discontinued the production of the device.

(2) **RoHS:** TI defines "RoHS" to mean semiconductor products that are compliant with the current EU RoHS requirements for all 10 RoHS substances, including the requirement that RoHS substance do not exceed 0.1% by weight in homogeneous materials. Where designed to be soldered at high temperatures, "RoHS" products are suitable for use in specified lead-free processes. TI may reference these types of products as "Pb-Free".

RoHS Exempt: TI defines "RoHS Exempt" to mean products that contain lead but are compliant with EU RoHS pursuant to a specific EU RoHS exemption.

Green: TI defines "Green" to mean the content of Chlorine (Cl) and Bromine (Br) based flame retardants meet JS709B low halogen requirements of <=1000ppm threshold. Antimony trioxide based flame retardants must also meet the <=1000ppm threshold requirement.

(3) MSL, Peak Temp. - The Moisture Sensitivity Level rating according to the JEDEC industry standard classifications, and peak solder temperature.

(4) There may be additional marking, which relates to the logo, the lot trace code information, or the environmental category on the device.

(5) Multiple Device Markings will be inside parentheses. Only one Device Marking contained in parentheses and separated by a "~" will appear on a device. If a line is indented then it is a continuation of the previous line and the two combined represent the entire Device Marking for that device.

⁽⁶⁾ Lead finish/Ball material - Orderable Devices may have multiple material finish options. Finish options are separated by a vertical ruled line. Lead finish/Ball material values may wrap to two lines if the finish value exceeds the maximum column width.

Important Information and Disclaimer:The information provided on this page represents TI's knowledge and belief as of the date that it is provided. TI bases its knowledge and belief on information provided by third parties, and makes no representation or warranty as to the accuracy of such information. Efforts are underway to better integrate information from third parties. TI has taken and continues to take reasonable steps to provide representative and accurate information but may not have conducted destructive testing or chemical analysis on incoming materials and chemicals. TI and TI suppliers consider certain information to be proprietary, and thus CAS numbers and other limited information may not be available for release.

In no event shall TI's liability arising out of such information exceed the total purchase price of the TI part(s) at issue in this document sold by TI to Customer on an annual basis.

TAPE AND REEL INFORMATION

QUADRANT ASSIGNMENTS FOR PIN 1 ORIENTATION IN TAPE

*All dimensions are nominal

Device	Package Type	Package Drawing	Pins	SPQ	Reel Diameter (mm)	Reel Width W1 (mm)	A0 (mm)	B0 (mm)	K0 (mm)	P1 (mm)	W (mm)	Pin1 Quadrant
TPS62840DLCR	VSON-HR	DLC	8	3000	180.0	8.4	1.8	2.25	1.15	4.0	8.0	Q1
TPS62840YBGR	DSBGA	YBG	6	3000	180.0	8.4	1.14	1.64	0.59	4.0	8.0	Q1
TPS62841DGRR	HVSSOP	DGR	8	2500	330.0	12.4	5.3	3.4	1.4	8.0	12.0	Q1
TPS62841DLCR	VSON-HR	DLC	8	3000	180.0	8.4	1.8	2.25	1.15	4.0	8.0	Q1
TPS62841YBGR	DSBGA	YBG	6	3000	180.0	8.4	1.14	1.64	0.59	4.0	8.0	Q1
TPS62842DGRR	HVSSOP	DGR	8	2500	330.0	12.4	5.3	3.4	1.4	8.0	12.0	Q1
TPS62849DLCR	VSON-HR	DLC	8	3000	180.0	8.4	1.8	2.25	1.15	4.0	8.0	Q1

TAPE AND REEL BOX DIMENSIONS

*All dimensions are nominal

Device	Package Type	Package Drawing	Pins	SPQ	Length (mm)	Width (mm)	Height (mm)
TPS62840DLCR	VSON-HR	DLC	8	3000	182.0	182.0	20.0
TPS62840YBGR	DSBGA	YBG	6	3000	182.0	182.0	20.0
TPS62841DGRR	HVSSOP	DGR	8	2500	366.0	364.0	50.0
TPS62841DLCR	VSON-HR	DLC	8	3000	182.0	182.0	20.0
TPS62841YBGR	DSBGA	YBG	6	3000	182.0	182.0	20.0
TPS62842DGRR	HVSSOP	DGR	8	2500	366.0	364.0	50.0
TPS62849DLCR	VSON-HR	DLC	8	3000	182.0	182.0	20.0

GENERIC PACKAGE VIEW

DLC 8

VSON-HR - 1 mm max height

2.0 x 1.5 mm, 0.5 mm pitch

PLASTIC SMALL OUTLINE - NO LEAD

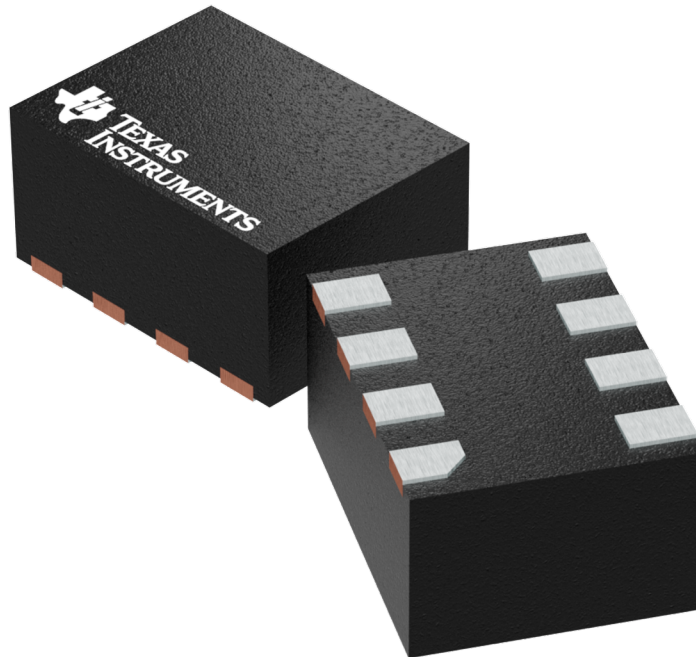

Images above are just a representation of the package family, actual package may vary.
Refer to the product data sheet for package details.

4224379/A

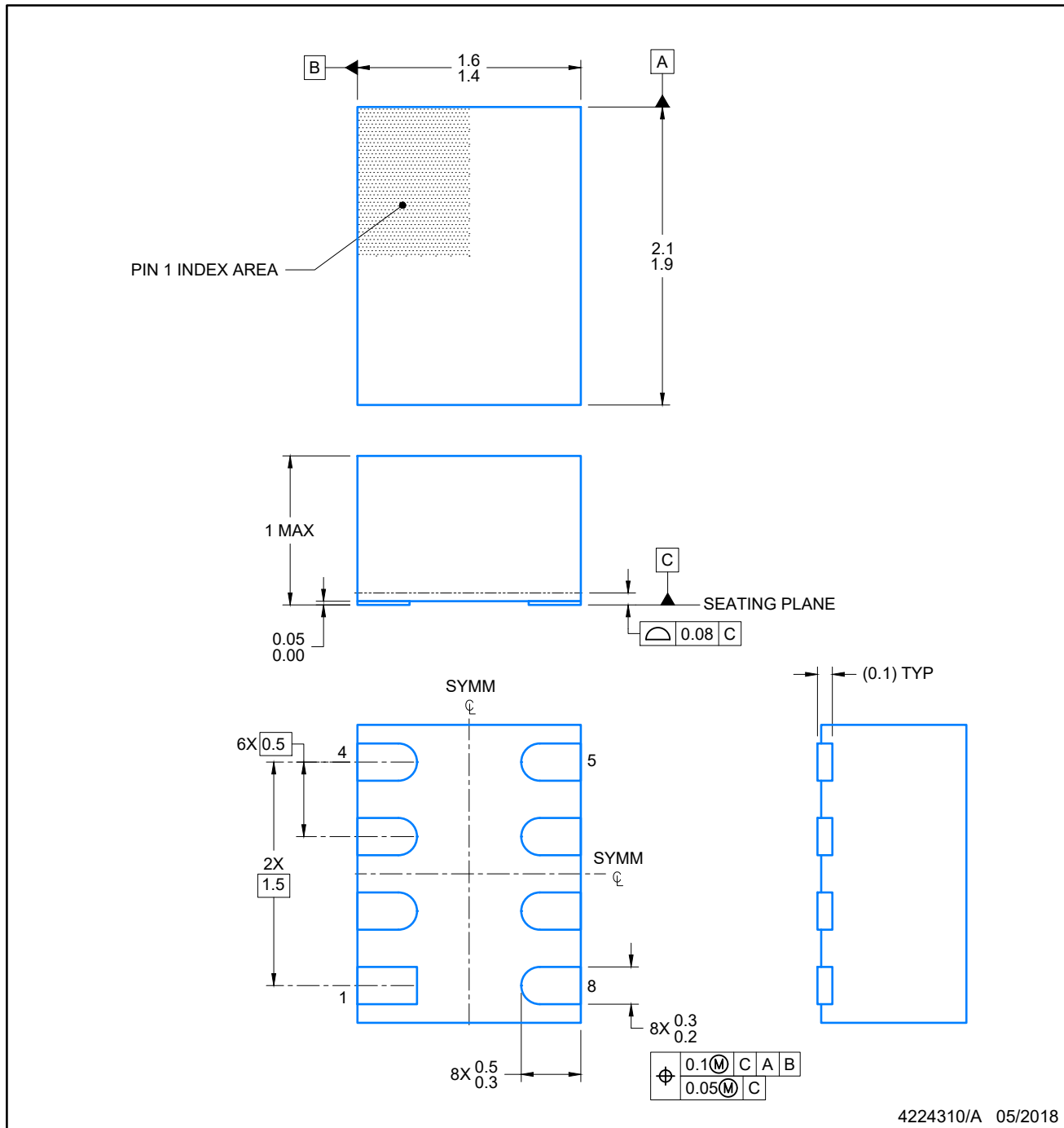

NOTES:

1. All linear dimensions are in millimeters. Any dimensions in parenthesis are for reference only. Dimensioning and tolerancing per ASME Y14.5M.
2. This drawing is subject to change without notice.

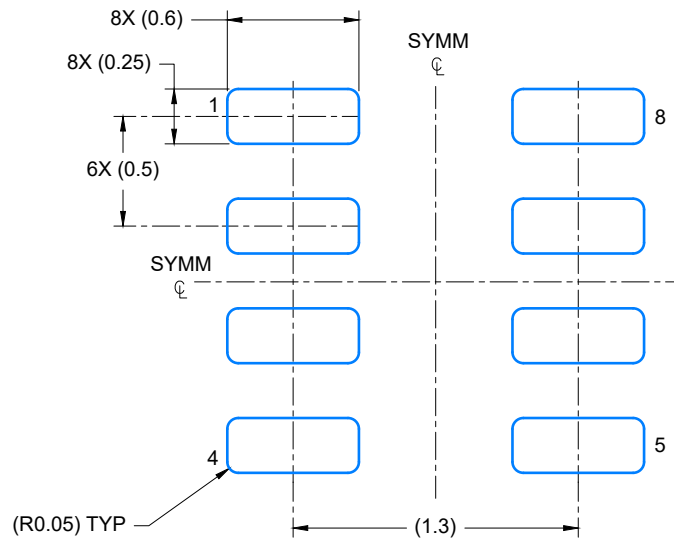

LAND PATTERN EXAMPLE
EXPOSED METAL SHOWN
SCALE: 30X

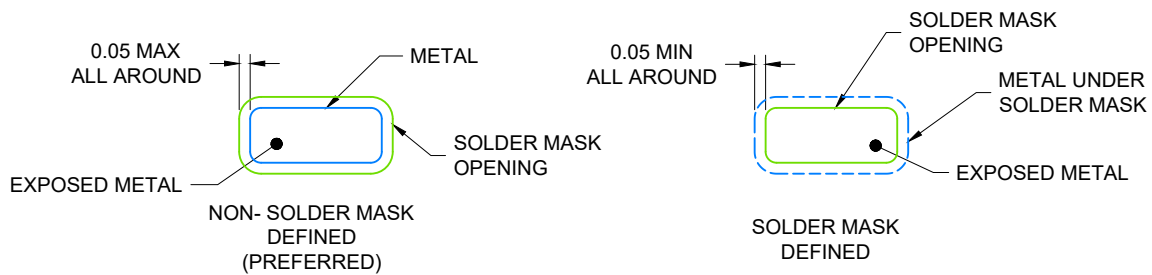

SOLDER MASK DETAILS

4224310/A 05/2018

NOTES: (continued)

- For more information, see Texas Instruments literature number SLUA271 (www.ti.com/lit/sl原因271).

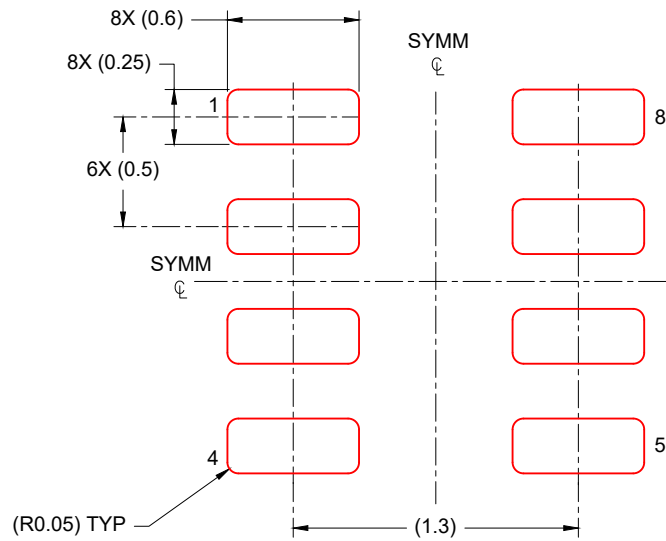

SOLDER PASTE EXAMPLE
BASED ON 0.1 mm THICK STENCIL
SCALE: 30X

4224310/A 05/2018

NOTES: (continued)

- 4. Laser cutting apertures with trapezoidal walls and rounded corners may offer better paste release. IPC-7525 may have alternate design recommendations.

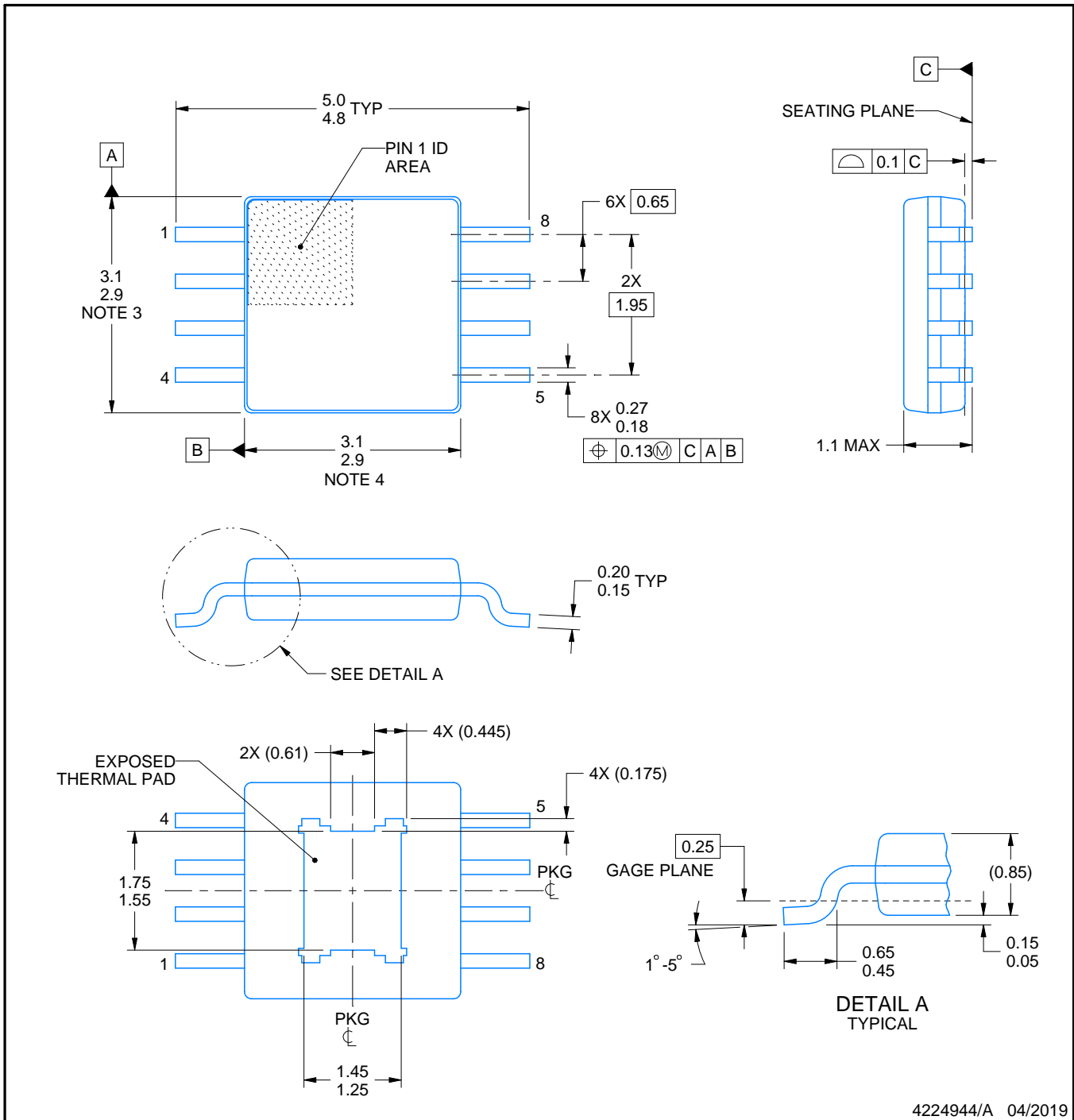

4224944/A 04/2019

PowerPAD is a trademark of Texas Instruments.

NOTES:

1. All linear dimensions are in millimeters. Any dimensions in parenthesis are for reference only. Dimensioning and tolerancing per ASME Y14.5M.
2. This drawing is subject to change without notice.
3. This dimension does not include mold flash, protrusions, or gate burrs. Mold flash, protrusions, or gate burrs shall not exceed 0.3 mm per side.
4. This dimension does not include interlead flash. Interlead flash shall not exceed 0.25 mm per side.

EXAMPLE BOARD LAYOUT

DGR0008A

VSSOP PowerPAD™ - 1.1 mm max height

PLASTIC SMALL OUTLINE

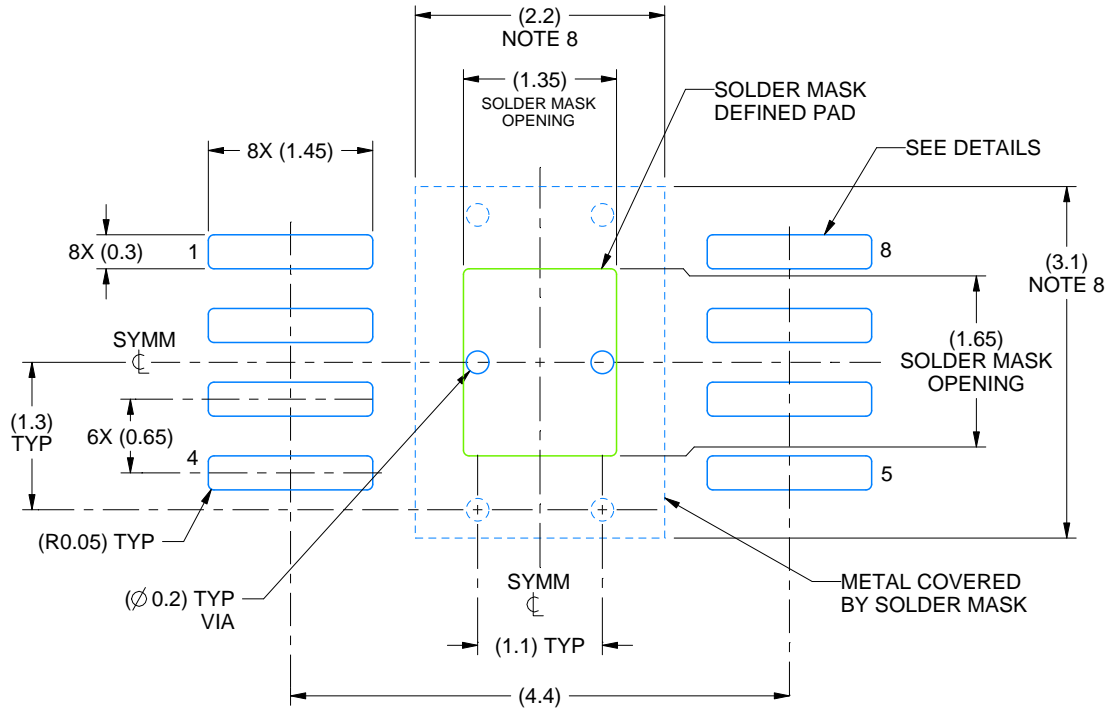

LAND PATTERN EXAMPLE
EXPOSED METAL SHOWN
SCALE:15X

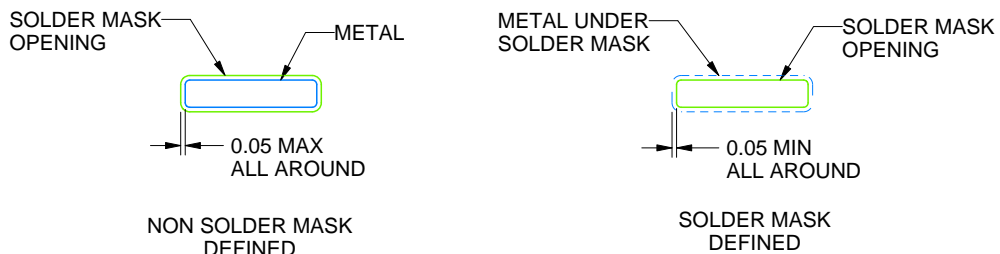

SOLDER MASK DETAILS

4224944/A 04/2019

NOTES: (continued)

5. Publication IPC-7351 may have alternate designs.
6. Solder mask tolerances between and around signal pads can vary based on board fabrication site.
7. This package is designed to be soldered to a thermal pad on the board. For more information, see Texas Instruments literature numbers SLMA002 (www.ti.com/lit/slma002) and SLMA004 (www.ti.com/lit/slma004).
8. Size of metal pad may vary due to creepage requirement.

EXAMPLE STENCIL DESIGN

DGR0008A

VSSOP PowerPAD™ - 1.1 mm max height

PLASTIC SMALL OUTLINE

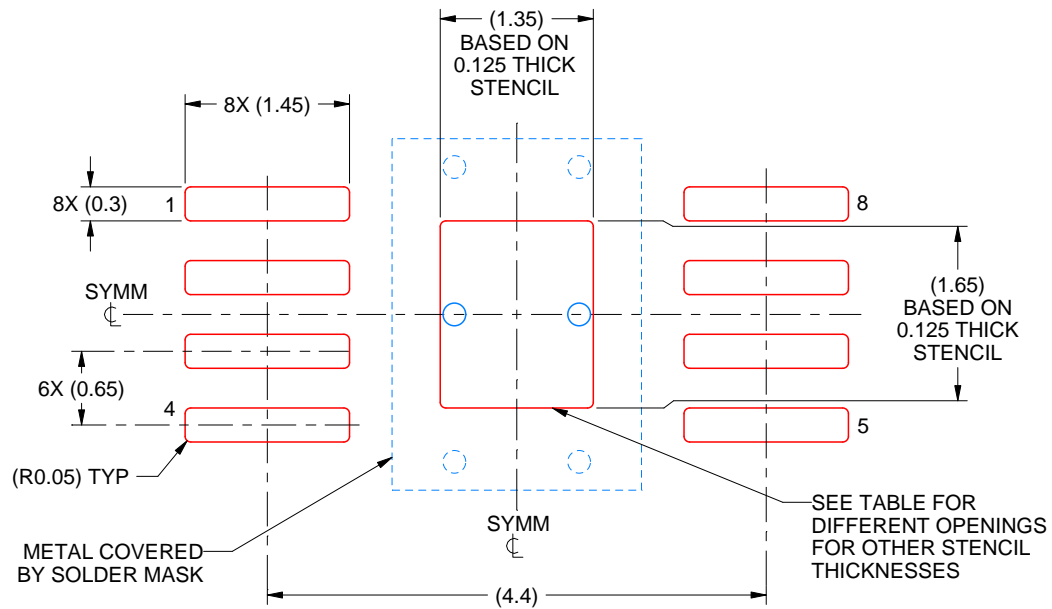

SOLDER PASTE EXAMPLE
EXPOSED PAD
100% PRINTED SOLDER COVERAGE BY AREA
SCALE:15X

STENCIL THICKNESS	SOLDER STENCIL OPENING
0.1	1.51 X 1.84
0.125	1.35 X 1.65 (SHOWN)
0.150	1.23 X 1.51
0.175	1.14 X 1.39

4224944/A 04/2019

NOTES: (continued)

9. Laser cutting apertures with trapezoidal walls and rounded corners may offer better paste release. IPC-7525 may have alternate design recommendations.
10. Board assembly site may have different recommendations for stencil design.

YBG0006

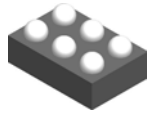

PACKAGE OUTLINE

DSBGA - 0.5 mm max height

DIE SIZE BALL GRID ARRAY

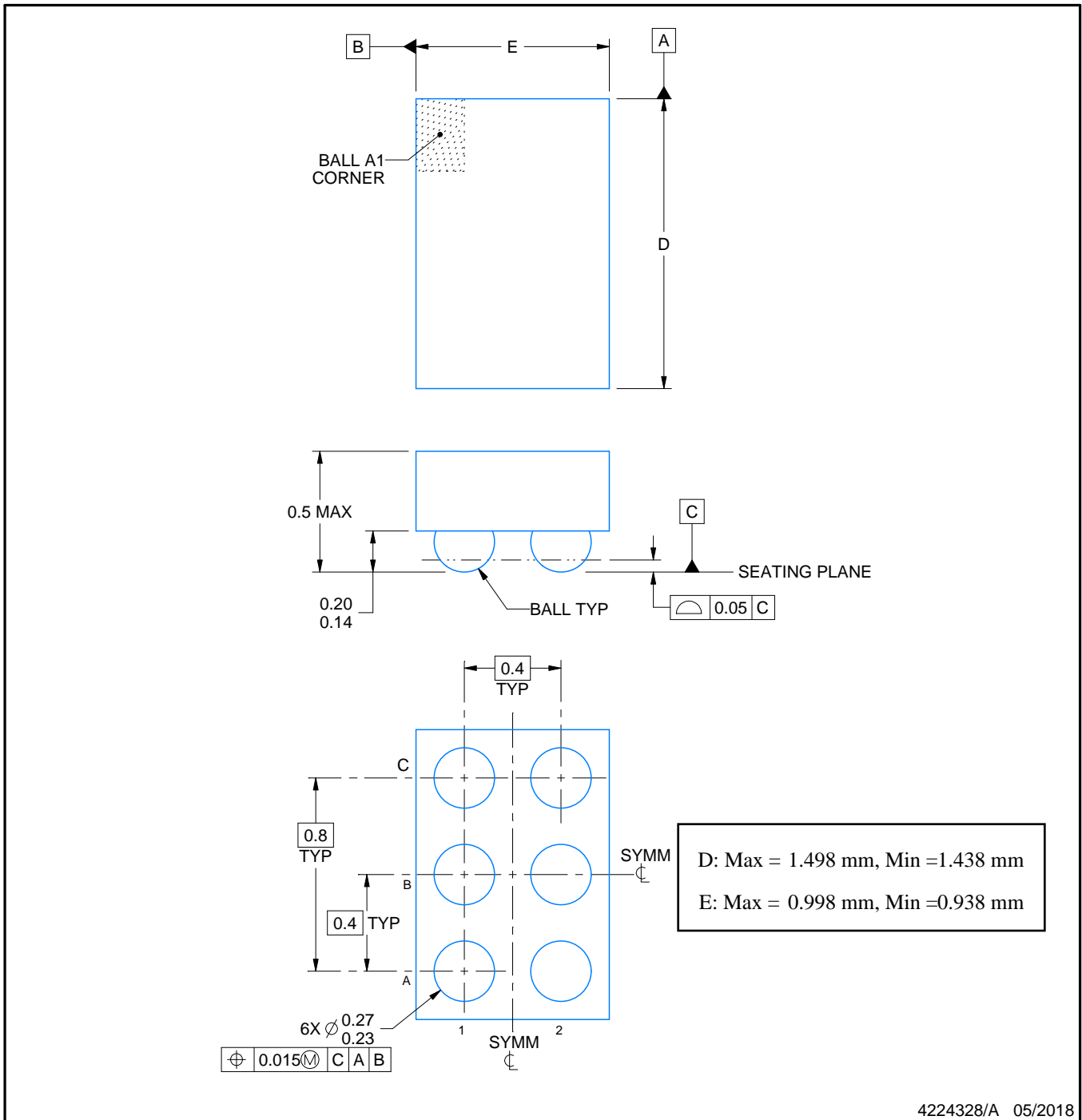

NOTES:

1. All linear dimensions are in millimeters. Any dimensions in parenthesis are for reference only. Dimensioning and tolerancing per ASME Y14.5M.
2. This drawing is subject to change without notice.

EXAMPLE BOARD LAYOUT

YBG0006

DSBGA - 0.5 mm max height

DIE SIZE BALL GRID ARRAY

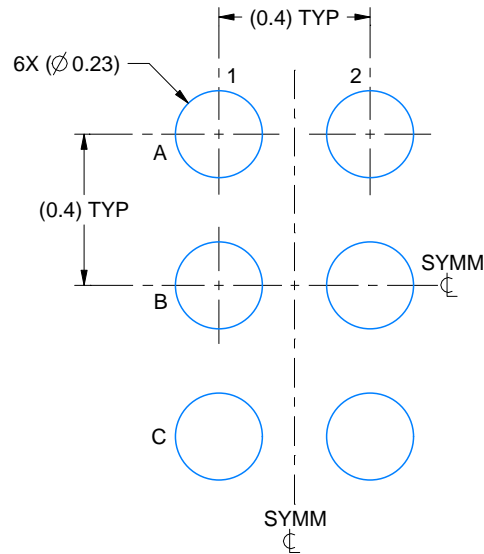

LAND PATTERN EXAMPLE
EXPOSED METAL SHOWN
SCALE: 50X

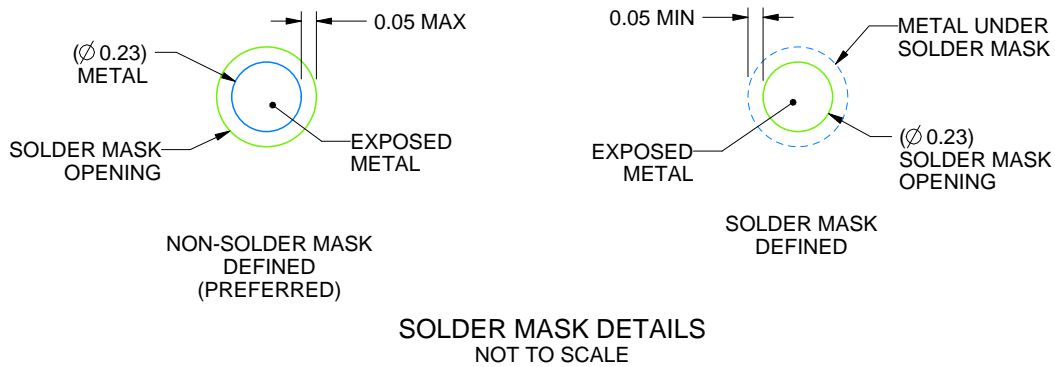

4224328/A 05/2018

NOTES: (continued)

- Final dimensions may vary due to manufacturing tolerance considerations and also routing constraints. See Texas Instruments Literature No. SNVA009 (www.ti.com/lit/snva009).

EXAMPLE STENCIL DESIGN

YBG0006

DSBGA - 0.5 mm max height

DIE SIZE BALL GRID ARRAY

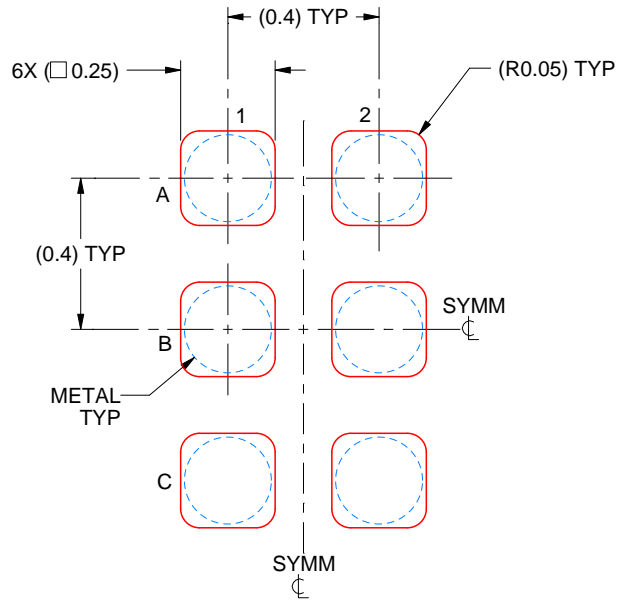

SOLDER PASTE EXAMPLE
BASED ON 0.1 mm THICK STENCIL
SCALE: 50X

4224328/A 05/2018

NOTES: (continued)

4. Laser cutting apertures with trapezoidal walls and rounded corners may offer better paste release.

IMPORTANT NOTICE AND DISCLAIMER

TI PROVIDES TECHNICAL AND RELIABILITY DATA (INCLUDING DATASHEETS), DESIGN RESOURCES (INCLUDING REFERENCE DESIGNS), APPLICATION OR OTHER DESIGN ADVICE, WEB TOOLS, SAFETY INFORMATION, AND OTHER RESOURCES "AS IS" AND WITH ALL FAULTS, AND DISCLAIMS ALL WARRANTIES, EXPRESS AND IMPLIED, INCLUDING WITHOUT LIMITATION ANY IMPLIED WARRANTIES OF MERCHANTABILITY, FITNESS FOR A PARTICULAR PURPOSE OR NON-INFRINGEMENT OF THIRD PARTY INTELLECTUAL PROPERTY RIGHTS.

These resources are intended for skilled developers designing with TI products. You are solely responsible for (1) selecting the appropriate TI products for your application, (2) designing, validating and testing your application, and (3) ensuring your application meets applicable standards, and any other safety, security, or other requirements. These resources are subject to change without notice. TI grants you permission to use these resources only for development of an application that uses the TI products described in the resource. Other reproduction and display of these resources is prohibited. No license is granted to any other TI intellectual property right or to any third party intellectual property right. TI disclaims responsibility for, and you will fully indemnify TI and its representatives against, any claims, damages, costs, losses, and liabilities arising out of your use of these resources.

TI's products are provided subject to TI's Terms of Sale (www.ti.com/legal/termsofsale.html) or other applicable terms available either on ti.com or provided in conjunction with such TI products. TI's provision of these resources does not expand or otherwise alter TI's applicable warranties or warranty disclaimers for TI products.

Mailing Address: Texas Instruments, Post Office Box 655303, Dallas, Texas 75265
Copyright © 2020, Texas Instruments Incorporated