

Automotive 8-bit MCU, with up to 32 Kbyte Flash, data EEPROM, 10-bit ADC, timers, LIN, SPI, I2C, 3 to 5.5 V

Datasheet - production data

Features



- AEC-Q10x qualified
- Core
 - Max f_{CPU} : 16 MHz
 - Advanced STM8A core with Harvard architecture and 3-stage pipeline
 - Average 1.6 cycles/instruction resulting in 10 MIPS at 16 MHz f_{CPU} for industry standard benchmark
- Memories
 - Flash Program memory: 16 to 32 Kbyte Flash; data retention 20 years at 55 °C after 1 cycle
 - Data memory: 0.5 to 1 Kbyte true data EEPROM; endurance 300 kcycle
 - RAM: 2 Kbyte
- Clock management
 - Low-power crystal resonator oscillator with external clock input
 - Internal, user-trimmable 16 MHz RC and low-power 128 kHz RC oscillators
 - Clock security system with clock monitor
- Reset and supply management
 - Wait/auto-wakeup/Halt low-power modes with user definable clock gating
 - Low consumption power-on and power-down reset
- Interrupt management
 - Nested interrupt controller with 32 vectors
 - Up to 34 external interrupts on 5 vectors
- Timers
 - Up to 2 general purpose 16-bit PWM timers with up to 3 CAPCOM channels each (IC, OC or PWM)
 - Advanced control timer: 16-bit, 4 CAPCOM channels, 3 complementary outputs, dead-time insertion and flexible synchronization
 - 8-bit AR basic timer with 8-bit prescaler

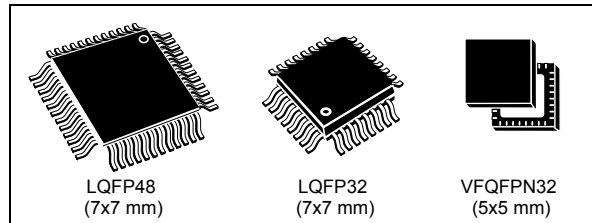

- Auto-wakeup timer
- Window and independent watchdog timers
- Communication interfaces
 - LINUART
 - LIN 2.2 compliant, master/slave modes with automatic resynchronization
 - SPI interface up to 8 Mbit/s or $f_{\text{MASTER}}/2$
 - I²C interface up to 400 Kbit/s
- Analog-to-digital converter (ADC)
 - 10-bit accuracy, 2LSB TUE accuracy, 2LSB TUE linearity ADC and up to 10 multiplexed channels with individual data buffer
 - Analog watchdog, scan and continuous sampling mode
- I/Os
 - Up to 38 user pins including 10 HS I/Os
 - Highly robust I/O design, immune against current injection
- Operating temperature up to 150 °C
- Qualification conforms to AEC-Q100 rev G

Contents

1	Introduction	9
2	Description	10
3	Product line-up	11
4	Block diagram	12
5	Product overview	14
5.1	STM8A central processing unit (CPU)	14
5.1.1	Architecture and registers	14
5.1.2	Addressing	14
5.1.3	Instruction set	14
5.2	Single wire interface module (SWIM) and debug module (DM)	15
5.2.1	SWIM	15
5.2.2	Debug module	15
5.3	Interrupt controller	15
5.4	Flash program and data EEPROM	15
5.4.1	Architecture	15
5.4.2	Write protection (WP)	16
5.4.3	Protection of user boot code (UBC)	16
5.4.4	Read-out protection (ROP)	17
5.5	Clock controller	17
5.5.1	Features	17
5.5.2	16 MHz high-speed internal RC oscillator (HSI)	18
5.5.3	128 kHz low-speed internal RC oscillator (LSI)	19
5.5.4	16 MHz high-speed external crystal oscillator (HSE)	19
5.5.5	External clock input	19
5.5.6	Clock security system (CSS)	19
5.6	Low-power operating modes	20
5.7	Timers	20
5.7.1	Watchdog timers	20
5.7.2	Auto-wakeup counter	21
5.7.3	Beeper	21

5.7.4	Advanced control and general purpose timers	21
5.7.5	Basic timer	22
5.8	Analog-to-digital converter (ADC)	23
5.9	Communication interfaces	23
5.9.1	Serial peripheral interface (SPI)	24
5.9.2	Inter integrated circuit (I ² C) interface	24
5.9.3	Universal asynchronous receiver/transmitter with LIN support (LINUART)	25
5.10	Input/output specifications	26
6	Pinouts and pin description	27
6.1	Package pinouts	27
6.2	Alternate function remapping	31
7	Memory and register map	32
7.1	Memory map	32
7.2	Register map	33
8	Interrupt table	43
9	Option bytes	44
10	Electrical characteristics	49
10.1	Parameter conditions	49
10.1.1	Minimum and maximum values	49
10.1.2	Typical values	49
10.1.3	Typical curves	49
10.1.4	Loading capacitor	49
10.1.5	Pin input voltage	50
10.2	Absolute maximum ratings	50
10.3	Operating conditions	52
10.3.1	VCAP external capacitor	54
10.3.2	Supply current characteristics	54
10.3.3	External clock sources and timing characteristics	57
10.3.4	Internal clock sources and timing characteristics	59
10.3.5	Memory characteristics	62
10.3.6	I/O port pin characteristics	63

	10.3.7	Reset pin characteristics	67
	10.3.8	TIM 1, 2, 3, and 4 timer specifications	69
	10.3.9	SPI serial peripheral interface	69
	10.3.10	I ² C interface characteristics	72
	10.3.11	10-bit ADC characteristics	73
	10.3.12	EMC characteristics	75
11		Package information	78
	11.1	VFQFPN32 package information	78
	11.2	LQFP48 package information	82
	11.3	LQFP32 package information	85
	11.4	Thermal characteristics	88
	11.4.1	Reference document	88
	11.4.2	Selecting the product temperature range	88
12		Ordering information	90
13		STM8 development tools	91
	13.1	Emulation and in-circuit debugging tools	91
	13.1.1	STice key features	91
	13.2	Software tools	92
	13.2.1	STM8 toolset	92
	13.2.2	C and assembly toolchains	92
	13.3	Programming tools	93
14		Revision history	94

List of tables

Table 1.	STM8AF6246/48/66/68 product line-up	11
Table 2.	Peripheral clock gating bit assignments in CLK_PCKENR1/2 registers	19
Table 3.	Advanced control and general purpose timers	21
Table 4.	TIM4	22
Table 5.	ADC naming	23
Table 6.	Communication peripheral naming correspondence	23
Table 7.	Legend/abbreviation	28
Table 8.	STM8AF6246/48/66/68 (32 Kbyte) microcontroller pin description	29
Table 9.	Memory model for the devices covered in this datasheet	33
Table 10.	I/O port hardware register map	33
Table 11.	General hardware register map	34
Table 12.	CPU/SWIM/debug module/interrupt controller registers	41
Table 13.	Temporary memory unprotection registers	42
Table 14.	STM8A interrupt table	43
Table 15.	Option bytes	44
Table 16.	Option byte description	46
Table 17.	Voltage characteristics	50
Table 18.	Current characteristics	51
Table 19.	Thermal characteristics	51
Table 20.	Operating lifetime	51
Table 21.	General operating conditions	52
Table 22.	Operating conditions at power-up/power-down	53
Table 23.	Total current consumption in Run, Wait and Slow mode. General conditions for V_{DD} apply, $T_A = -40$ to 150 °C	54
Table 24.	Total current consumption in Halt and Active-halt modes. General conditions for V_{DD} apply, $T_A = -40$ to 55 °C	55
Table 25.	Oscillator current consumption	55
Table 26.	Programming current consumption	56
Table 27.	Typical peripheral current consumption $V_{DD} = 5.0$ V	56
Table 28.	HSE user external clock characteristics	57
Table 29.	HSE oscillator characteristics	58
Table 30.	HSI oscillator characteristics	59
Table 31.	LSI oscillator characteristics	60
Table 32.	Flash program memory/data EEPROM memory	62
Table 33.	Flash program memory	62
Table 34.	Data memory	62
Table 35.	I/O static characteristics	63
Table 36.	NRST pin characteristics	67
Table 37.	TIM 1, 2, 3, and 4 electrical specifications	69
Table 38.	SPI characteristics	69
Table 39.	I ² C characteristics	72
Table 40.	ADC characteristics	73
Table 41.	ADC accuracy for $V_{DDA} = 5$ V	74
Table 42.	EMS data	75
Table 43.	EMI data	76
Table 44.	ESD absolute maximum ratings	76
Table 45.	Electrical sensitivities	77
Table 46.	VFQFPN32 - 32-pin, 5x5 mm, 0.5 mm pitch very thin profile fine pitch quad	

	flat package mechanical data	79
Table 47.	LQFP48 - 48-pin, 7 x 7 mm low-profile quad flat package mechanical data	83
Table 48.	LQFP32 - 32-pin, 7 x 7 mm low-profile quad flat package mechanical data	86
Table 49.	Thermal characteristics	88
Table 50.	Document revision history	94

List of figures

Figure 1.	STM8AF6246/48/66/68 block diagram	12
Figure 2.	Flash memory organization of STM8AF6246/48/66/68	16
Figure 3.	VFQFPN/LQFP 32-pin pinout	27
Figure 4.	LQFP 48-pin pinout	28
Figure 5.	Register and memory map of STM8A products	32
Figure 6.	Pin loading conditions	49
Figure 7.	Pin input voltage	50
Figure 8.	f_{CPUmax} versus V_{DD}	52
Figure 9.	External capacitor C_{EXT}	54
Figure 10.	Typ. $I_{DD(RUN)HSE}$ vs. V_{DD} @ $f_{CPU} = 16$ MHz, peripheral = on	56
Figure 11.	Typ. $I_{DD(RUN)HSE}$ vs. f_{CPU} @ $V_{DD} = 5.0$ V, peripheral = on	56
Figure 12.	Typ. $I_{DD(RUN)HSI}$ vs. V_{DD} @ $f_{CPU} = 16$ MHz, peripheral = off	57
Figure 13.	Typ. $I_{DD(WFI)HSE}$ vs. V_{DD} @ $f_{CPU} = 16$ MHz, peripheral = on	57
Figure 14.	Typ. $I_{DD(WFI)HSE}$ vs. f_{CPU} @ $V_{DD} = 5.0$ V, peripheral = on	57
Figure 15.	Typ. $I_{DD(WFI)HSI}$ vs. V_{DD} @ $f_{CPU} = 16$ MHz, peripheral = off	57
Figure 16.	HSE external clock source	58
Figure 17.	HSE oscillator circuit diagram	59
Figure 18.	Typical HSI frequency vs V_{DD}	60
Figure 19.	Typical LSI frequency vs V_{DD}	61
Figure 20.	Typical V_{IL} and V_{IH} vs V_{DD} @ four temperatures	64
Figure 21.	Typical pull-up resistance R_{PU} vs V_{DD} @ four temperatures	64
Figure 22.	Typical pull-up current I_{pu} vs V_{DD} @ four temperatures	65
Figure 23.	Typ. V_{OL} @ $V_{DD} = 3.3$ V (standard ports)	65
Figure 24.	Typ. V_{OL} @ $V_{DD} = 5.0$ V (standard ports)	65
Figure 25.	Typ. V_{OL} @ $V_{DD} = 3.3$ V (true open drain ports)	65
Figure 26.	Typ. V_{OL} @ $V_{DD} = 5.0$ V (true open drain ports)	65
Figure 27.	Typ. V_{OL} @ $V_{DD} = 3.3$ V (high sink ports)	66
Figure 28.	Typ. V_{OL} @ $V_{DD} = 5.0$ V (high sink ports)	66
Figure 29.	Typ. $V_{DD} - V_{OH}$ @ $V_{DD} = 3.3$ V (standard ports)	66
Figure 30.	Typ. $V_{DD} - V_{OH}$ @ $V_{DD} = 5.0$ V (standard ports)	66
Figure 31.	Typ. $V_{DD} - V_{OH}$ @ $V_{DD} = 3.3$ V (high sink ports)	66
Figure 32.	Typ. $V_{DD} - V_{OH}$ @ $V_{DD} = 5.0$ V (high sink ports)	66
Figure 33.	Typical NRST V_{IL} and V_{IH} vs V_{DD} @ four temperatures	67
Figure 34.	Typical NRST pull-up resistance R_{PU} vs V_{DD}	68
Figure 35.	Typical NRST pull-up current I_{pu} vs V_{DD}	68
Figure 36.	Recommended reset pin protection	68
Figure 37.	SPI timing diagram where slave mode and $CPHA = 0$	70
Figure 38.	SPI timing diagram where slave mode and $CPHA = 1$	70
Figure 39.	SPI timing diagram - master mode	71
Figure 40.	Typical application with ADC	73
Figure 41.	ADC accuracy characteristics	74
Figure 42.	VFQFPN32 - 32-pin, 5x5 mm, 0.5 mm pitch very thin profile fine pitch quad flat package outline	78
Figure 43.	VFQFPN32 - 32-pin, 5x5 mm, 0.5 mm pitch very thin profile fine pitch quad flat package recommended footprint	80
Figure 44.	VFQFPN32 marking example (package top view)	81
Figure 45.	LQFP48 - 48-pin, 7 x 7 mm low-profile quad flat package outline	82
Figure 46.	LQFP48 - 48-pin, 7 x 7 mm low-profile quad flat package	

	recommended footprint.	84
Figure 47.	LQFP48 marking example (package top view).	84
Figure 48.	LQFP32 - 32-pin, 7 x 7 mm low-profile quad flat package outline	85
Figure 49.	LQFP32 - 32-pin, 7 x 7 mm low-profile quad flat package recommended footprint.	87
Figure 50.	LQFP32 marking example (package top view).	87
Figure 51.	STM8AF6246/48/66/68 ordering information scheme ^{(1) (2)}	90

1 Introduction

This datasheet refers to the STM8AF6246, STM8AF6248, STM8AF6266 and STM8AF6268 products with 16 to 32 Kbyte of Flash program memory.

In the order code, the letter 'F' refers to product versions with data EEPROM and 'H' refers to product versions without data EEPROM. The identifiers 'F' and 'H' do not coexist in a given order code.

The datasheet contains the description of family features, pinout, electrical characteristics, mechanical data and ordering information.

- For complete information on the STM8A microcontroller memory, registers and peripherals, please refer to STM8S series and STM8AF series 8-bit microcontrollers reference manual (RM0016).
- For information on programming, erasing and protection of the internal Flash memory please refer to the STM8 Flash programming manual (PM0051).
- For information on the debug and SWIM (single wire interface module) refer to the STM8 SWIM communication protocol and debug module user manual (UM0470).
- For information on the STM8 core, please refer to the STM8 CPU programming manual (PM0044).

2 Description

The STM8AF6246, STM8AF6248, STM8AF6266 and STM8AF6268 automotive 8-bit microcontrollers offer from 16 to 32 Kbyte of Flash program memory and integrated true data EEPROM. They are referred to as medium density STM8A devices in STM8S series and STM8AF series 8-bit microcontrollers reference manual (RM0016).

All devices of the STM8A product line provide the following benefits: reduced system cost, performance and robustness, short development cycles, and product longevity.

The system cost is reduced thanks to an integrated true data EEPROM for up to 300 k write/erase cycles and a high system integration level with internal clock oscillators, watchdog, and brown-out reset.

Device performance is ensured by a clock frequency of up to 16 MHz CPU and enhanced characteristics which include robust I/O, independent watchdogs (with a separate clock source), and a clock security system.

Short development cycles are guaranteed due to application scalability across a common family product architecture with compatible pinout, memory map and modular peripherals. Full documentation is offered with a wide choice of development tools.

Product longevity is ensured in the STM8A family thanks to their advanced core which is made in a state-of-the-art technology for automotive applications with 3.3 V to 5 V operating supply.

All STM8A and ST7 microcontrollers are supported by the same tools including STVD/STVP development environment, the STice emulator and a low-cost, third party in-circuit debugging tool.

3 Product line-up

Table 1. STM8AF6246/48/66/68 product line-up

Order code	Package	Medium density Flash program memory (byte)	RAM (byte)	Data EE (byte)	10-bit A/D ch.	Timers (IC/OC/PWM)	Serial interfaces	I/O wakeup pins																		
STM8AF/P6268	LQFP48 (7x7)	32 K	2 K	1 K	10	1x8-bit: TIM4 3x16-bit: TIM1, TIM2, TIM3 (9/9/9)	LIN(UART), SPI, I ² C	38/35																		
STM8AF/P6248		16 K		0.5 K					STM8AF/P6266	LQFP32 (7x7)	32 K	1 K	7	1x8-bit: TIM4 3x16-bit: TIM1, TIM2, TIM3 (8/8/8)	LIN(UART), SPI, I ² C	25/23	STM8AF/P6246	16 K	0.5 K	STM8AF/P6266	VFQFPN32	32 K	1 K	7	1x8-bit: TIM4 3x16-bit: TIM1, TIM2, TIM3 (8/8/8)	LIN(UART), SPI, I ² C
STM8AF/P6266	LQFP32 (7x7)	32 K		1 K	7	1x8-bit: TIM4 3x16-bit: TIM1, TIM2, TIM3 (8/8/8)	LIN(UART), SPI, I ² C		25/23																	
STM8AF/P6246		16 K		0.5 K						STM8AF/P6266	VFQFPN32	32 K	1 K	7	1x8-bit: TIM4 3x16-bit: TIM1, TIM2, TIM3 (8/8/8)	LIN(UART), SPI, I ² C	25/23	STM8AF/P6246	16 K	0.5 K						
STM8AF/P6266	VFQFPN32	32 K		1 K	7	1x8-bit: TIM4 3x16-bit: TIM1, TIM2, TIM3 (8/8/8)	LIN(UART), SPI, I ² C		25/23																	
STM8AF/P6246		16 K		0.5 K																						

4 Block diagram

Figure 1. STM8AF6246/48/66/68 block diagram



1. Legend:
 - ADC: Analog-to-digital converter
 - beCAN: Controller area network
 - BOR: Brownout reset
 - I²C: Inter-integrated circuit multimaster interface
 - IWDG: Independent window watchdog
 - LINUART: Local interconnect network universal asynchronous receiver transmitter
 - POR: Power on reset
 - SPI: Serial peripheral interface
 - SWIM: Single wire interface module
 - USART: Universal synchronous asynchronous receiver transmitter
 - Window WDG: Window watchdog

5 Product overview

This section describes the family features that are implemented in the products covered by this datasheet.

For more detailed information on each feature please refer to STM8S series and STM8AF series 8-bit microcontrollers reference manual (RM0016).

5.1 STM8A central processing unit (CPU)

The 8-bit STM8A core is a modern CISC core and has been designed for code efficiency and performance. It contains 21 internal registers (six directly addressable in each execution context), 20 addressing modes including indexed indirect and relative addressing and 80 instructions.

5.1.1 Architecture and registers

- Harvard architecture
- 3-stage pipeline
- 32-bit wide program memory bus with single cycle fetching for most instructions
- X and Y 16-bit index registers, enabling indexed addressing modes with or without offset and read-modify-write type data manipulations
- 8-bit accumulator
- 24-bit program counter with 16-Mbyte linear memory space
- 16-bit stack pointer with access to a 64 Kbyte stack
- 8-bit condition code register with seven condition flags for the result of the last instruction.

5.1.2 Addressing

- 20 addressing modes
- Indexed indirect addressing mode for look-up tables located anywhere in the address space
- Stack pointer relative addressing mode for efficient implementation of local variables and parameter passing

5.1.3 Instruction set

- 80 instructions with 2-byte average instruction size
- Standard data movement and logic/arithmetic functions
- 8-bit by 8-bit multiplication
- 16-bit by 8-bit and 16-bit by 16-bit division
- Bit manipulation
- Data transfer between stack and accumulator (push/pop) with direct stack access
- Data transfer using the X and Y registers or direct memory-to-memory transfers

5.2 Single wire interface module (SWIM) and debug module (DM)

5.2.1 SWIM

The single wire interface module, SWIM, together with an integrated debug module, permits non-intrusive, real-time in-circuit debugging and fast memory programming. The interface can be activated in all device operation modes and can be connected to a running device (hot plugging). The maximum data transmission speed is 145 bytes/ms.

5.2.2 Debug module

The non-intrusive debugging module features a performance close to a full-flavored emulator. Besides memory and peripheral operation, CPU operation can also be monitored in real-time by means of shadow registers.

- R/W of RAM and peripheral registers in real-time
- R/W for all resources when the application is stopped
- Breakpoints on all program-memory instructions (software breakpoints), except the interrupt vector table
- Two advanced breakpoints and 23 predefined breakpoint configurations

5.3 Interrupt controller

- Nested interrupts with three software priority levels
- 21 interrupt vectors with hardware priority
- Five vectors for external interrupts (up to 34 depending on the package)
- Trap and reset interrupts

5.4 Flash program and data EEPROM

- 16 Kbyte to 32 Kbyte of medium density single voltage program Flash memory
- Up to 1 Kbyte true (not emulated) data EEPROM
- Read while write: writing in the data memory is possible while executing code in the Flash program memory

The whole Flash program memory and data EEPROM are factory programmed with 0x00.

5.4.1 Architecture

- The memory is organized in blocks of 128 bytes each
- Read granularity: 1 word = 4 bytes
- Write/erase granularity: 1 word (4 bytes) or 1 block (128 bytes) in parallel
- Writing, erasing, word and block management is handled automatically by the memory interface.

5.4.2 Write protection (WP)

Write protection in application mode is intended to avoid unintentional overwriting of the memory. The write protection can be removed temporarily by executing a specific sequence in the user software.

5.4.3 Protection of user boot code (UBC)

If the user chooses to update the Flash program memory using a specific boot code to perform in application programming (IAP), this boot code needs to be protected against unwanted modification.

In the STM8A a memory area of up to 32 Kbyte can be protected from overwriting at user option level. Other than the standard write protection, the UBC protection can exclusively be modified via the debug interface, the user software cannot modify the UBC protection status.

The UBC memory area contains the reset and interrupt vectors and its size can be adjusted in increments of 512 bytes by programming the UBC and NUBC option bytes (see [Section 9: Option bytes on page 44](#)).

Figure 2. Flash memory organization of STM8AF6246/48/66/68

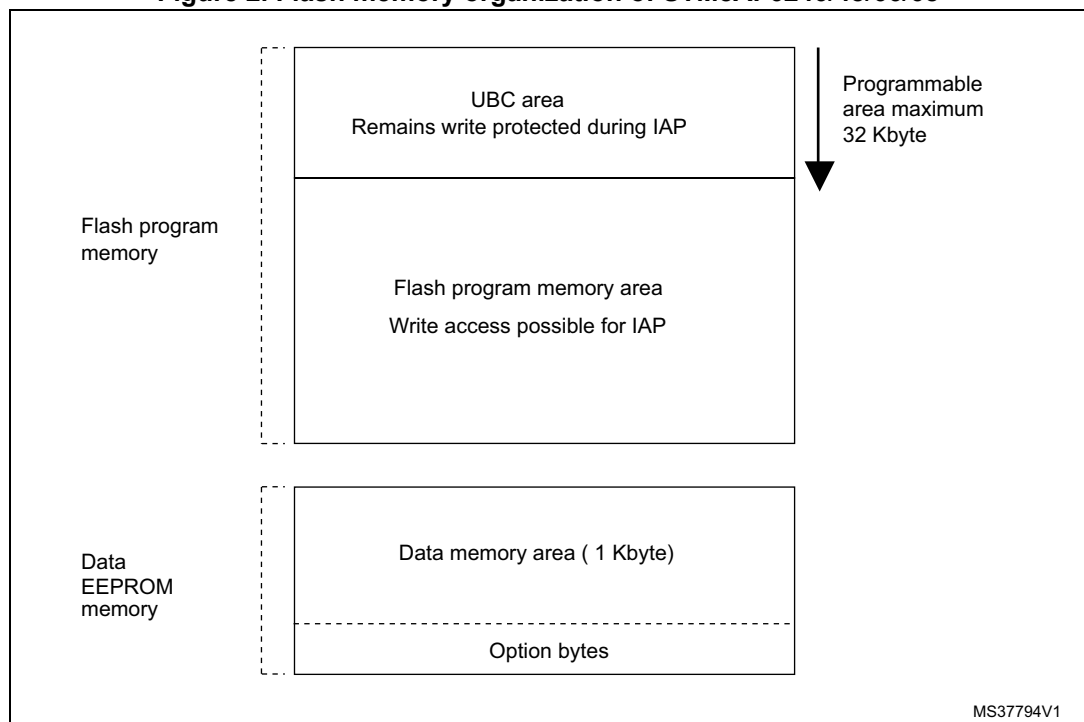

5.4.4 Read-out protection (ROP)

The STM8A provides a read-out protection of the code and data memory which can be activated by an option byte setting (see the ROP option byte in section 10).

The read-out protection prevents reading and writing Flash program memory, data memory and option bytes via the debug module and SWIM interface. This protection is active in all device operation modes. Any attempt to remove the protection by overwriting the ROP option byte triggers a global erase of the program and data memory.

The ROP circuit may provide a temporary access for debugging or failure analysis. The temporary read access is protected by a user defined, 8-byte keyword stored in the option bytes area. This keyword must be entered via the SWIM interface to temporarily unlock the device.

If desired, the temporary unlock mechanism can be permanently disabled by the user through OPT6/NOPT6 option bytes.

5.5 Clock controller

The clock controller distributes the system clock coming from different oscillators to the core and the peripherals. It also manages clock gating for low-power modes and ensures clock robustness.

5.5.1 Features

- **Clock sources**
 - 16 MHz high-speed internal RC oscillator (HSI)
 - 128 kHz low-speed internal RC (LSI)
 - 1-16 MHz high-speed external crystal (HSE)
 - Up to 16 MHz high-speed user-external clock (HSE user-ext)
- **Reset:** After reset the microcontroller restarts by default with an internal 2-MHz clock (16 MHz/8). The clock source and speed can be changed by the application program as soon as the code execution starts.
- **Safe clock switching:** Clock sources can be changed safely on the fly in Run mode through a configuration register. The clock signal is not switched until the new clock source is ready. The design guarantees glitch-free switching.
- **Clock management:** To reduce power consumption, the clock controller can stop the clock to the core or individual peripherals.
- **Wakeup:** In case the device wakes up from low-power modes, the internal RC oscillator (16 MHz/8) is used for quick startup. After a stabilization time, the device switches to the clock source that was selected before Halt mode was entered.
- **Clock security system (CSS):** The CSS permits monitoring of external clock sources and automatic switching to the internal RC (16 MHz/8) in case of a clock failure.
- **Configurable main clock output (CCO):** This feature permits to output a clock signal for use by the application.

5.5.2 16 MHz high-speed internal RC oscillator (HSI)

- Default clock after reset 2 MHz (16 MHz/8)
- Fast wakeup time

User trimming

The register CLK_HSITRIMR with three trimming bits plus one additional bit for the sign permits frequency tuning by the application program. The adjustment range covers all possible frequency variations versus supply voltage and temperature. This trimming does not change the initial production setting.

For reason of compatibility with other devices from the STM8A family, a special mode with only two trimming bits plus sign can be selected. This selection is controlled with the HSITRIM0 bit in the option byte registers OPT3 and NOPT3.

5.5.3 128 kHz low-speed internal RC oscillator (LSI)

The frequency of this clock is 128 kHz and it is independent from the main clock. It drives the independent watchdog or the AWU wakeup timer.

In systems which do not need independent clock sources for the watchdog counters, the 128 kHz signal can be used as the system clock. This configuration has to be enabled by setting an option byte (OPT3/OPT3N, bit LSI_EN).

5.5.4 16 MHz high-speed external crystal oscillator (HSE)

The external high-speed crystal oscillator can be selected to deliver the main clock in normal Run mode. It operates with quartz crystals and ceramic resonators.

- Frequency range: 1 MHz to 16 MHz
- Crystal oscillation mode: preferred fundamental
- I/Os: standard I/O pins multiplexed with OSCIN, OSCOUT

5.5.5 External clock input

An external clock signal can be applied to the OSCIN input pin of the crystal oscillator. The frequency range is 0 to 16 MHz.

5.5.6 Clock security system (CSS)

The clock security system protects against a system stall in case of an external crystal clock failure.

In case of a clock failure an interrupt is generated and the high-speed internal clock (HSI) is automatically selected with a frequency of 2 MHz (16 MHz/8).

Table 2. Peripheral clock gating bit assignments in CLK_PCKENR1/2 registers

Bit	Peripheral clock	Bit	Peripheral clock	Bit	Peripheral clock	Bit	Peripheral clock
PCKEN17	TIM1	PCKEN13	LINUART	PCKEN27	Reserved	PCKEN23	ADC
PCKEN16	TIM3	PCKEN12	Reserved	PCKEN26	Reserved	PCKEN22	AWU
PCKEN15	TIM2	PCKEN11	SPI	PCKEN25	Reserved	PCKEN21	Reserved
PCKEN14	TIM4	PCKEN10	I ² C	PCKEN24	Reserved	PCKEN20	Reserved

5.6 Low-power operating modes

For efficient power management, the application can be put in one of four different low power modes. Users can configure each mode to obtain the best compromise between lowest power consumption, fastest start-up time and available wakeup sources.

- **Wait mode**
In this mode, the CPU is stopped but peripherals are kept running. The wakeup is performed by an internal or external interrupt or reset.
- **Active-halt mode with regulator on**
In this mode, the CPU and peripheral clocks are stopped. An internal wakeup is generated at programmable intervals by the auto wake up unit (AWU). The main voltage regulator is kept powered on, so current consumption is higher than in Active-halt mode with regulator off, but the wakeup time is faster. Wakeup is triggered by the internal AWU interrupt, external interrupt or reset.
- **Active-halt mode with regulator off**
This mode is the same as Active-halt with regulator on, except that the main voltage regulator is powered off, so the wake up time is slower.
- **Halt mode**
CPU and peripheral clocks are stopped, the main voltage regulator is powered off. Wakeup is triggered by external event or reset.

In all modes the CPU and peripherals remain permanently powered on, the system clock is applied only to selected modules. The RAM content is preserved and the brown-out reset circuit remains activated.

5.7 Timers

5.7.1 Watchdog timers

The watchdog system is based on two independent timers providing maximum security to the applications. The watchdog timer activity is controlled by the application program or option bytes. Once the watchdog is activated, it cannot be disabled by the user program without going through reset.

Window watchdog timer

The window watchdog is used to detect the occurrence of a software fault, usually generated by external interferences or by unexpected logical conditions, which cause the application program to abandon its normal sequence.

The window function can be used to trim the watchdog behavior to match the application timing perfectly. The application software must refresh the counter before time-out and during a limited time window. If the counter is refreshed outside this time window, a reset is issued.

Independent watchdog timer

The independent watchdog peripheral can be used to resolve malfunctions due to hardware or software failures.

It is clocked by the 128 kHz LSI internal RC clock source, and thus stays active even in case of a CPU clock failure. If the hardware watchdog feature is enabled through the device option bits, the watchdog is automatically enabled at power-on, and generates a reset unless the key register is written by software before the counter reaches the end of count.

5.7.2 Auto-wakeup counter

This counter is used to cyclically wakeup the device in Active-halt mode. It can be clocked by the internal 128 kHz internal low-frequency RC oscillator or external clock.

LSI clock can be internally connected to TIM3 input capture channel 1 for calibration.

5.7.3 Beeper

This function generates a rectangular signal in the range of 1, 2 or 4 kHz which can be output on a pin. This is useful when audible sounds without interference need to be generated for use in the application.

5.7.4 Advanced control and general purpose timers

STM8A devices described in this datasheet, contain up to three 16-bit advanced control and general purpose timers providing nine CAPCOM channels in total. A CAPCOM channel can be used either as input compare, output compare or PWM channel. These timers are named TIM1, TIM2 and TIM3.

Table 3. Advanced control and general purpose timers

Timer	Counter width	Counter type	Prescaler factor	Channels	Inverted outputs	Repetition counter	trigger unit	External trigger	Break input
TIM1	16-bit	Up/down	1 to 65536	4	3	Yes	Yes	Yes	Yes
TIM2	16-bit	Up	2^n n = 0 to 15	3	None	No	No	No	No
TIM3	16-bit	Up	2^n n = 0 to 15	2	None	No	No	No	No

TIM1: Advanced control timer

This is a high-end timer designed for a wide range of control applications. With its complementary outputs, dead-time control and center-aligned PWM capability, the field of applications is extended to motor control, lighting and bridge driver.

- 16-bit up, down and up/down AR (auto-reload) counter with 16-bit fractional prescaler.
- Four independent CAPCOM channels configurable as input capture, output compare, PWM generation (edge and center aligned mode) and single pulse mode output
- Trigger module which allows the interaction of TIM1 with other on-chip peripherals. In the present implementation it is possible to trigger the ADC upon a timer event.
- External trigger to change the timer behavior depending on external signals
- Break input to force the timer outputs into a defined state
- Three complementary outputs with adjustable dead time
- Interrupt sources: 4 x input capture/output compare, 1 x overflow/update, 1 x break

TIM2 and TIM3: 16-bit general purpose timers

- 16-bit auto-reload up-counter
- 15-bit prescaler adjustable to fixed power of two ratios 1...32768
- Timers with three or two individually configurable CAPCOM channels
- Interrupt sources: 2 or 3 x input capture/output compare, 1 x overflow/update

5.7.5 Basic timer

The typical usage of this timer (TIM4) is the generation of a clock tick.

Table 4. TIM4

Timer	Counter width	Counter type	Prescaler factor	Channels	Inverted outputs	Repetition counter	trigger unit	External trigger	Break input
TIM4	8-bit	Up	2 ⁿ n = 0 to 7	0	None	No	No	No	No

- 8-bit auto-reload, adjustable prescaler ratio to any power of two from 1 to 128
- Clock source: master clock
- Interrupt source: 1 x overflow/update

5.8 Analog-to-digital converter (ADC)

The STM8A products described in this datasheet contain a 10-bit successive approximation ADC with up to 16 multiplexed input channels, depending on the package.

The ADC name differs between the datasheet and STM8S series and STM8AF series 8-bit microcontrollers reference manual (see [Table 5](#)).

Table 5. ADC naming

Peripheral name in datasheet	Peripheral name in reference manual (RM0016)
ADC	ADC1

ADC features

- 10-bit resolution
- Single and continuous conversion modes
- Programmable prescaler: f_{MASTER} divided by 2 to 18
- Conversion trigger on timer events and external events
- Interrupt generation at end of conversion
- Selectable alignment of 10-bit data in 2 x 8 bit result register
- Shadow registers for data consistency
- ADC input range: $V_{SSA} \leq V_{IN} \leq V_{DDA}$
- Analog watchdog
- Schmitt-trigger on analog inputs can be disabled to reduce power consumption
- Scan mode (single and continuous)
- Dedicated result register for each conversion channel
- Buffer mode for continuous conversion

Note: An additional AIN12 analog input is not selectable in ADC scan mode or with analog watchdog. Values converted from AIN12 are stored only into the ADC_DRH/ADC_DRL registers.

5.9 Communication interfaces

The following sections give a brief overview of the communication peripheral. Some peripheral names differ between the datasheet and STM8S series and STM8AF series 8-bit microcontrollers reference manual (see [Table 6](#)).

Table 6. Communication peripheral naming correspondence

Peripheral name in datasheet	Peripheral name in reference manual (RM0016)
LINUART	UART2

5.9.1 Serial peripheral interface (SPI)

The devices covered by this datasheet contain one SPI. The SPI is available on all the supported packages.

- Maximum speed: 10 Mbit/s or $f_{\text{MASTER}}/2$ both for master and slave
- Full duplex synchronous transfers
- Simplex synchronous transfers on two lines with a possible bidirectional data line
- Master or slave operation - selectable by hardware or software
- CRC calculation
- 1 byte Tx and Rx buffer
- Slave mode/master mode management by hardware or software for both master and slave
- Programmable clock polarity and phase
- Programmable data order with MSB-first or LSB-first shifting
- Dedicated transmission and reception flags with interrupt capability
- SPI bus busy status flag
- Hardware CRC feature for reliable communication:
 - CRC value can be transmitted as last byte in Tx mode
 - CRC error checking for last received byte

5.9.2 Inter integrated circuit (I²C) interface

The devices covered by this datasheet contain one I²C interface. The interface is available on all the supported packages.

- I²C master features:
 - Clock generation
 - Start and stop generation
- I²C slave features:
 - Programmable I²C address detection
 - Stop bit detection
- Generation and detection of 7-bit/10-bit addressing and general call
- Supports different communication speeds:
 - Standard speed (up to 100 kHz),
 - Fast speed (up to 400 kHz)
- Status flags:
 - Transmitter/receiver mode flag
 - End-of-byte transmission flag
 - I²C busy flag
- Error flags:
 - Arbitration lost condition for master mode
 - Acknowledgment failure after address/data transmission
 - Detection of misplaced start or stop condition
 - Overrun/underrun if clock stretching is disabled

- Interrupt:
 - Successful address/data communication
 - Error condition
 - Wakeup from Halt
- Wakeup from Halt on address detection in slave mode

5.9.3 Universal asynchronous receiver/transmitter with LIN support (LINUART)

The devices covered by this datasheet contain one LINUART interface. The interface is available on all the supported packages. The LINUART is an asynchronous serial communication interface which supports extensive LIN functions tailored for LIN slave applications. In LIN mode it is compliant to the LIN standards rev 1.2 to rev 2.2.

Detailed feature list:

LIN mode

Master mode:

- LIN break and delimiter generation
- LIN break and delimiter detection with separate flag and interrupt source for read back checking.

Slave mode:

- Autonomous header handling – one single interrupt per valid header
- Mute mode to filter responses
- Identifier parity error checking
- LIN automatic resynchronization, allowing operation with internal RC oscillator (HSI) clock source
- Break detection at any time, even during a byte reception
- Header errors detection:
 - Delimiter too short
 - Synch field error
 - Deviation error (if automatic resynchronization is enabled)
 - Framing error in synch field or identifier field
 - Header time-out

UART mode

- Full duplex, asynchronous communications - NRZ standard format (mark/space)
- High-precision baud rate generator
 - A common programmable transmit and receive baud rates up to $f_{\text{MASTER}}/16$
- Programmable data word length (8 or 9 bits) – 1 or 2 stop bits – parity control
- Separate enable bits for transmitter and receiver
- Error detection flags
- Reduced power consumption mode
- Multi-processor communication - enter mute mode if address match does not occur
- Wakeup from mute mode (by idle line detection or address mark detection)
- Two receiver wakeup modes:
 - Address bit (MSB)
 - Idle line

5.10 Input/output specifications

The product features four different I/O types:

- Standard I/O 2 MHz
- Fast I/O up to 10 MHz
- High sink 8 mA, 2 MHz
- True open drain (I²C interface)

To decrease EMI (electromagnetic interference), high sink I/Os have a limited maximum slew rate. The rise and fall times are similar to those of standard I/Os.

The analog inputs are equipped with a low leakage analog switch. Additionally, the schmitt-trigger input stage on the analog I/Os can be disabled in order to reduce the device standby consumption.

STM8A I/Os are designed to withstand current injection. For a negative injection current of 4 mA, the resulting leakage current in the adjacent input does not exceed 1 μA . Thanks to this feature, external protection diodes against current injection are no longer required.

6 Pinouts and pin description

6.1 Package pinouts

Figure 3. VFQFPN/LQFP 32-pin pinout



1. (HS) high sink capability.

Figure 4. LQFP 48-pin pinout



2. (HS) high sink capability.

Table 7. Legend/abbreviation

Type	I= input, O = output, S = power supply	
Level	Input	CM = CMOS (standard for all I/Os)
	Output	HS = High sink (8 mA)
Output speed	O1 = Standard (up to 2 MHz) O2 = Fast (up to 10 MHz) O3 = Fast/slow programmability with slow as default state after reset O4 = Fast/slow programmability with fast as default state after reset	
Port and control configuration	Input	float = floating, wpu = weak pull-up
	Output	T = true open drain, OD = open drain, PP = push pull
Reset state	Bold X (pin state after reset release). Unless otherwise specified, the pin state is the same during the reset phase (i.e. "under reset") and after internal reset release (i.e. at reset state).	

Table 8. STM8AF6246/48/66/68 (32 Kbyte) microcontroller pin description⁽¹⁾⁽²⁾

Pin number		Pin name	Type	Input			Output				Main function (after reset)	Default alternate function	Alternate function after remap [option bit]
LQFP48	VFQFPN/LQFP32			floating	wpu	Ext. interrupt	High sink	Speed	OD	PP			
1	1	NRST	I/O	-	X	-	-	-	-	-	Reset	-	
2	2	PA1/OSCIN ⁽³⁾	I/O	X	X	-	-	O1	X	X	Port A1	Resonator/crystal in	
3	3	PA2/OSCOU	I/O	X	X	X	-	O1	X	X	Port A2	Resonator/crystal out	
4	-	V _{SSIO_1}	S	-	-	-	-	-	-	-	I/O ground	-	
5	4	V _{SS}	S	-	-	-	-	-	-	-	Digital ground	-	
6	5	V _{CAP}	S	-	-	-	-	-	-	-	1.8 V regulator capacitor	-	
7	6	V _{DD}	S	-	-	-	-	-	-	-	Digital power supply	-	
8	7	V _{DDIO_1}	S	-	-	-	-	-	-	-	I/O power supply	-	
-	8	PF4/AIN12 ⁽⁴⁾⁽⁵⁾	I/O	X	X	-	-	O1	X	X	Port F4	Analog input 12	
9	-	PA3/TIM2_CH3	I/O	X	X	X	-	O1	X	X	Port A3	Timer 2 - channel 3	TIM3_CH1 [AFR1]
10	-	PA4	I/O	X	X	X	-	O3	X	X	Port A4	-	
11	-	PA5	I/O	X	X	X	-	O3	X	X	Port A5	-	
12	-	PA6	I/O	X	X	X	-	O3	X	X	Port A6	-	
13	9	V _{DDA}	S	-	-	-	-	-	-	-	Analog power supply	-	
14	10	V _{SSA}	S	-	-	-	-	-	-	-	Analog ground	-	
15	-	PB7/AIN7	I/O	X	X	X	-	O1	X	X	Port B7	Analog input 7	
16	-	PB6/AIN6	I/O	X	X	X	-	O1	X	X	Port B6	Analog input 6	
17	11	PB5/AIN5	I/O	X	X	X	-	O1	X	X	Port B5	Analog input 5	I ² C_SDA [AFR6]
18	12	PB4/AIN4	I/O	X	X	X	-	O1	X	X	Port B4	Analog input 4	I ² C_SCL [AFR6]
19	13	PB3/AIN3	I/O	X	X	X	-	O1	X	X	Port B3	Analog input 3	TIM1_ETR [AFR5]
20	14	PB2/AIN2	I/O	X	X	X	-	O1	X	X	Port B2	Analog input	TIM1_NCC3 [AFR5]
21	15	PB1/AIN1	I/O	X	X	X	-	O1	X	X	Port B1	Analog input 1	TIM1_NCC2 [AFR5]
22	16	PB0/AIN0	I/O	X	X	X	-	O1	X	X	Port B0	Analog input 0	TIM1_NCC1 [AFR5]
23	-	PE7/AIN8	I/O	X	X	-	-	O1	X	X	Port E7	Analog input 8	-

Table 8. STM8AF6246/48/66/68 (32 Kbyte) microcontroller pin description⁽¹⁾⁽²⁾ (continued)

Pin number		Pin name	Type	Input			Output				Main function (after reset)	Default alternate function	Alternate function after remap [option bit]
LQFP48	VFGFPN/LQFP32			floating	wpu	Ext. interrupt	High sink	Speed	OD	PP			
24		PE6/AIN9	I/O	X	X	X	-	O1	X	X	Port E7	Analog input 9	-
25	17	PE5/SPI_NSS	I/O	X	X	X	-	O1	X	X	Port E5	SPI master/slave select	-
26	18	PC1/TIM1_CH1	I/O	X	X	X	HS	O3	X	X	Port C1	Timer 1 - channel 1	-
27	19	PC2/TIM1_CH2	I/O	X	X	X	HS	O3	X	X	Port C2	Timer 1 - channel 2	-
28	20	PC3/TIM1_CH3	I/O	X	X	X	HS	O3	X	X	Port C3	Timer 1 - channel 3	-
29	21	PC4/TIM1_CH4	I/O	X	X	X	HS	O3	X	X	Port C4	Timer 1 - channel 4	-
30	22	PC5/SPI_SCK	I/O	X	X	X		O3	X	X	Port C5	SPI clock	-
31	-	V _{SSIO_2}	S	-	-	-	-	-	-	-		I/O ground	-
32	-	V _{DDIO_2}	S	-	-	-	-	-	-	-		I/O power supply	-
33	23	PC6/SPI_MOSI	I/O	X	X	X	-	O3	X	X	Port C6	SPI master out/ slave in	-
34	24	PC7/SPI_MISO	I/O	X	X	X	-	O3	X	X	Port C7	SPI master in/ slave out	-
35	-	PG0	I/O	X	X	-	-	O1	X	X	Port G0	-	-
36	-	PG1	I/O	X	X	-	-	O1	X	X	Port G1	-	-
37	-	PE3/TIM1_BKIN	I/O	X	X	X	-	O1	X	X	Port E3	Timer 1 - break input	-
38	-	PE2/I ² C_SDA	I/O	X	-	X	-	O1	T ⁽⁶⁾	-	Port E2	I ² C data	-
39	-	PE1/I ² C_SCL	I/O	X	-	X	-	O1	T ⁽⁶⁾	-	Port E1	I ² C clock	-
40	-	PE0/CLK_CCO	I/O	X	X	X	-	O3	X	X	Port E0	Configurable clock output	-
41	25	PD0/TIM3_CH2	I/O	X	X	X	HS	O3	X	X	Port D0	Timer 3 - channel 2	TIM1_BKIN [AFR3]/ CLK_CCO [AFR2]
42	26	PD1/SWIM ⁽⁷⁾	I/O	X	X	X	HS	O4	X	X	Port D1	SWIM data interface	-
43	27	PD2/TIM3_CH1	I/O	X	X	X	HS	O3	X	X	Port D2	Timer 3 - channel 1	TIM2_CH3 [AFR1]
44	28	PD3/TIM2_CH2	I/O	X	X	X	HS	O3	X	X	Port D3	Timer 2 - channel 2	ADC_ETR [AFR0]
45	29	PD4/TIM2_CH1/ BEEP	I/O	X	X	X	HS	O3	X	X	Port D4	Timer 2 - channel 1	BEEP output [AFR7]
46	30	PD5/ LINUART_TX	I/O	X	X	X	-	O1	X	X	Port D5	LINUART data transmit	-

Table 8. STM8AF6246/48/66/68 (32 Kbyte) microcontroller pin description⁽¹⁾⁽²⁾ (continued)

Pin number		Pin name	Type	Input			Output				Main function (after reset)	Default alternate function	Alternate function after remap [option bit]
LQFP48	VQFPN/LQFP32			floating	wpu	Ext. interrupt	High sink	Speed	OD	PP			
47	31	PD6/ LINUART_RX	I/O	X	X	X	-	O1	X	X	Port D6	LINUART data receive	-
48	32	PD7/TLI ⁽⁸⁾	I/O	X	X	X	-	O1	X	X	Port D7	Top level interrupt	-

1. Refer to [Table 7](#) for the definition of the abbreviations.
2. Reset state is shown in bold.
3. In Halt/Active-halt mode this pad behaves in the following way:
 - the input/output path is disabled
 - if the HSE clock is used for wakeup, the internal weak pull up is disabled
 - if the HSE clock is off, internal weak pull up setting from corresponding OR bit is used
 By managing the OR bit correctly, it must be ensured that the pad is not left floating during Halt/Active-halt.
4. On this pin, a pull-up resistor as specified in [Table 35](#). I/O static characteristics is enabled during the reset phase of the product.
5. AIN12 is not selectable in ADC scan mode or with analog watchdog.
6. In the open-drain output column, 'T' defines a true open-drain I/O (P-buffer, weak pull-up, and protection diode to V_{DD} are not implemented)
7. The PD1 pin is in input pull-up during the reset phase and after reset release.
8. If this pin is configured as interrupt pin, it will trigger the TLI.

6.2 Alternate function remapping

As shown in the rightmost column of [Table 8](#), some alternate functions can be remapped at different I/O ports by programming one of eight AFR (alternate function remap) option bits. Refer to [Section 9: Option bytes on page 44](#). When the remapping option is active, the default alternate function is no longer available.

To use an alternate function, the corresponding peripheral must be enabled in the peripheral registers.

Alternate function remapping does not effect GPIO capabilities of the I/O ports (see the GPIO section of STM8S series and STM8AF series 8-bit microcontrollers reference manual, RM0016).

7 Memory and register map

7.1 Memory map

Figure 5. Register and memory map of STM8A products

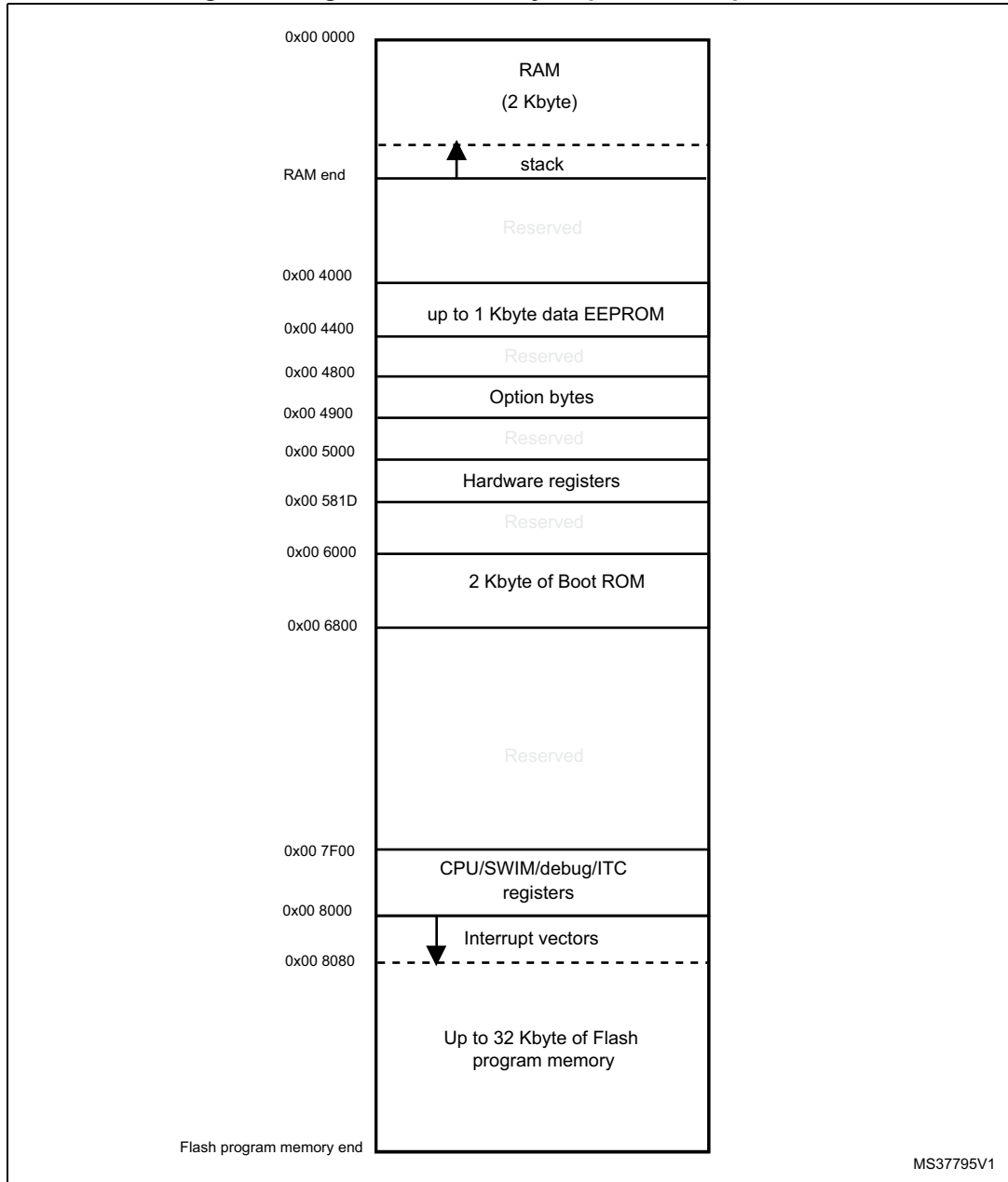

Table 9. Memory model for the devices covered in this datasheet

Flash program memory size	Flash program memory end address	RAM size	RAM end address	Stack roll-over address
32K	0x00 0FFFF	2K	0x00 07FF	0x00 0600
16K	0x00 0BFFF			

7.2 Register map

In this section the memory and register map of the devices covered by this datasheet is described. For a detailed description of the functionality of the registers, refer to STM8S series and STM8AF series 8-bit microcontrollers reference manual, RM0016.

Table 10. I/O port hardware register map

Address	Block	Register label	Register name	Reset status
0x00 5000	Port A	PA_ODR	Port A data output latch register	0x00
0x00 5001		PA_IDR	Port A input pin value register	0xFF ⁽¹⁾
0x00 5002		PA_DDR	Port A data direction register	0x00
0x00 5003		PA_CR1	Port A control register 1	0x00
0x00 5004		PA_CR2	Port A control register 2	0x00
0x00 5005	Port B	PB_ODR	Port B data output latch register	0x00
0x00 5006		PB_IDR	Port B input pin value register	0xFF ⁽¹⁾
0x00 5007		PB_DDR	Port B data direction register	0x00
0x00 5008		PB_CR1	Port B control register 1	0x00
0x00 5009		PB_CR2	Port B control register 2	0x00
0x00 500A	Port C	PC_ODR	Port C data output latch register	0x00
0x00 500B		PC_IDR	Port C input pin value register	0xFF ⁽¹⁾
0x00 500C		PC_DDR	Port C data direction register	0x00
0x00 500D		PC_CR1	Port C control register 1	0x00
0x00 500E		PC_CR2	Port C control register 2	0x00
0x00 500F	Port D	PD_ODR	Port D data output latch register	0x00
0x00 5010		PD_IDR	Port D input pin value register	0xFF ⁽¹⁾
0x00 5011		PD_DDR	Port D data direction register	0x00
0x00 5012		PD_CR1	Port D control register 1	0x02
0x00 5013		PD_CR2	Port D control register 2	0x00

Table 10. I/O port hardware register map (continued)

Address	Block	Register label	Register name	Reset status
0x00 5014	Port E	PE_ODR	Port E data output latch register	0x00
0x00 5015		PE_IDR	Port E input pin value register	0xXX ⁽¹⁾
0x00 5016		PE_DDR	Port E data direction register	0x00
0x00 5017		PE_CR1	Port E control register 1	0x00
0x00 5018		PE_CR2	Port E control register 2	0x00
0x00 5019	Port F	PF_ODR	Port F data output latch register	0x00
0x00 501A		PF_IDR	Port F input pin value register	0xXX ⁽¹⁾
0x00 501B		PF_DDR	Port F data direction register	0x00
0x00 501C		PF_CR1	Port F control register 1	0x00
0x00 501D		PF_CR2	Port F control register 2	0x00
0x00 501E	Port G	PG_ODR	Port G data output latch register	0x00
0x00 501F		PG_IDR	Port G input pin value register	0xXX ⁽¹⁾
0x00 5020		PG_DDR	Port G data direction register	0x00
0x00 5021		PG_CR1	Port G control register 1	0x00
0x00 5022		PG_CR2	Port G control register 2	0x00

1. Depends on the external circuitry.

Table 11. General hardware register map

Address	Block	Register label	Register name	Reset status
0x00 505A	Flash	FLASH_CR1	Flash control register 1	0x00
0x00 505B		FLASH_CR2	Flash control register 2	0x00
0x00 505C		FLASH_NCR2	Flash complementary control register 2	0xFF
0x00 505D		FLASH_FPR	Flash protection register	0x00
0x00 505E		FLASH_NFPR	Flash complementary protection register	0xFF
0x00 505F		FLASH_IAPSR	Flash in-application programming status register	0x40
0x00 5060 to 0x00 5061	Reserved area (2 bytes)			
0x00 5062	Flash	FLASH_PUKR	Flash Program memory unprotection register	0x00
0x00 5063	Reserved area (1 byte)			
0x00 5064	Flash	FLASH_DUKR	Data EEPROM unprotection register	0x00
0x00 5065 to 0x00 509F	Reserved area (59 bytes)			

Table 11. General hardware register map (continued)

Address	Block	Register label	Register name	Reset status
0x00 50A0	ITC	EXTI_CR1	External interrupt control register 1	0x00
0x00 50A1		EXTI_CR2	External interrupt control register 2	0x00
0x00 50A2 to 0x00 50B2	Reserved area (17 bytes)			
0x00 50B3	RST	RST_SR	Reset status register	0xXX ⁽¹⁾
0x00 50B4 to 0x00 50BF	Reserved area (12 bytes)			
0x00 50C0	CLK	CLK_ICKR	Internal clock control register	0x01
0x00 50C1		CLK_ECKR	External clock control register	0x00
0x00 50C2	Reserved area (1 byte)			
0x00 50C3	CLK	CLK_CMSR	Clock master status register	0xE1
0x00 50C4		CLK_SWR	Clock master switch register	0xE1
0x00 50C5		CLK_SWCR	Clock switch control register	0xXX
0x00 50C6		CLK_CKDIVR	Clock divider register	0x18
0x00 50C7		CLK_PCKENR1	Peripheral clock gating register 1	0xFF
0x00 50C8		CLK_CSSR	Clock security system register	0x00
0x00 50C9		CLK_CCOR	Configurable clock control register	0x00
0x00 50CA		CLK_PCKENR2	Peripheral clock gating register 2	0xFF
0x00 50CB		Reserved area (1 byte)		
0x00 50CC	CLK	CLK_HSITRIMR	HSI clock calibration trimming register	0x00
0x00 50CD		CLK_SWIMCCR	SWIM clock control register	0bXXXX XXX0
0x00 50CE to 0x00 50D0	Reserved area (3 bytes)			
0x00 50D1	WWDG	WWDG_CR	WWDG control register	0x7F
0x00 50D2		WWDG_WR	WWDG window register	0x7F
0x00 50D3 to 0x00 50DF	Reserved area (13 bytes)			
0x00 50E0	IWDG	IWDG_KR	IWDG key register	0xXX ⁽²⁾
0x00 50E1		IWDG_PR	IWDG prescaler register	0x00
0x00 50E2		IWDG_RLR	IWDG reload register	0xFF
0x00 50E3 to 0x00 50EF	Reserved area (13 bytes)			
0x00 50F0	AWU	AWU_CSR1	AWU control/status register 1	0x00
0x00 50F1		AWU_APR	AWU asynchronous prescaler buffer register	0x3F
0x00 50F2		AWU_TBR	AWU timebase selection register	0x00

Table 11. General hardware register map (continued)

Address	Block	Register label	Register name	Reset status	
0x00 50F3	BEEP	BEEP_CSR	BEEP control/status register	0x1F	
0x00 50F4 to 0x00 50FF	Reserved area (12 bytes)				
0x00 5200	SPI	SPI_CR1	SPI control register 1	0x00	
0x00 5201		SPI_CR2	SPI control register 2	0x00	
0x00 5202		SPI_ICR	SPI interrupt control register	0x00	
0x00 5203		SPI_SR	SPI status register	0x02	
0x00 5204		SPI_DR	SPI data register	0x00	
0x00 5205		SPI_CRCPR	SPI CRC polynomial register	0x07	
0x00 5206		SPI_RXCR	SPI Rx CRC register	0xFF	
0x00 5207		SPI_TXCR	SPI Tx CRC register	0xFF	
0x00 5208 to 0x00 520F	Reserved area (8 bytes)				
0x00 5210	I2C	I2C_CR1	I2C control register 1	0x00	
0x00 5211		I2C_CR2	I2C control register 2	0x00	
0x00 5212		I2C_FREQR	I2C frequency register	0x00	
0x00 5213		I2C_OARL	I2C own address register low	0x00	
0x00 5214		I2C_OARH	I2C own address register high	0x00	
0x00 5215		Reserved area (1 byte)			
0x00 5216		I2C_DR	I2C data register	0x00	
0x00 5217		I2C_SR1	I2C status register 1	0x00	
0x00 5218		I2C_SR2	I2C status register 2	0x00	
0x00 5219		I2C_SR3	I2C status register 3	0x00	
0x00 521A		I2C_I2R	I2C interrupt control register	0x00	
0x00 521B		I2C_CCRL	I2C clock control register low	0x00	
0x00 521C		I2C_CCRH	I2C clock control register high	0x00	
0x00 521D		I2C_TRISER	I2C TRISE register	0x02	
0x00 521E to 0x00 523F		Reserved area (24 bytes)			

Table 11. General hardware register map (continued)

Address	Block	Register label	Register name	Reset status	
0x00 5240	LINUART	UART2_SR	LINUART status register	0xC0	
0x00 5241		UART2_DR	LINUART data register	0xFF	
0x00 5242		UART2_BRR1	LINUART baud rate register 1	0x00	
0x00 5243		UART2_BRR2	LINUART baud rate register 2	0x00	
0x00 5244		UART2_CR1	LINUART control register 1	0x00	
0x00 5245		UART2_CR2	LINUART control register 2	0x00	
0x00 5246		UART2_CR3	LINUART control register 3	0x00	
0x00 5247		UART2_CR4	LINUART control register 4	0x00	
0x00 5248		Reserved			
0x00 5249		UART2_CR6	LINUART control register 6	0x00	
0x00 524A to 0x00 524F		Reserved area (6 bytes)			
0x00 5250	TIM1	TIM1_CR1	TIM1 control register 1	0x00	
0x00 5251		TIM1_CR2	TIM1 control register 2	0x00	
0x00 5252		TIM1_SMCR	TIM1 slave mode control register	0x00	
0x00 5253		TIM1_ETR	TIM1 external trigger register	0x00	
0x00 5254		TIM1_IER	TIM1 Interrupt enable register	0x00	
0x00 5255		TIM1_SR1	TIM1 status register 1	0x00	
0x00 5256		TIM1_SR2	TIM1 status register 2	0x00	
0x00 5257		TIM1_EGR	TIM1 event generation register	0x00	
0x00 5258		TIM1_CCMR1	TIM1 capture/compare mode register 1	0x00	
0x00 5259		TIM1_CCMR2	TIM1 capture/compare mode register 2	0x00	
0x00 525A		TIM1_CCMR3	TIM1 capture/compare mode register 3	0x00	
0x00 525B		TIM1_CCMR4	TIM1 capture/compare mode register 4	0x00	
0x00 525C		TIM1_CCER1	TIM1 capture/compare enable register 1	0x00	
0x00 525D		TIM1_CCER2	TIM1 capture/compare enable register 2	0x00	
0x00 525E		TIM1_CNTRH	TIM1 counter high	0x00	
0x00 525F		TIM1_CNTRL	TIM1 counter low	0x00	
0x00 5260		TIM1_PSCRH	TIM1 prescaler register high	0x00	
0x00 5261		TIM1_PSCRL	TIM1 prescaler register low	0x00	
0x00 5262		TIM1_ARRH	TIM1 auto-reload register high	0xFF	
0x00 5263		TIM1_ARRL	TIM1 auto-reload register low	0xFF	
0x00 5264	TIM1_RCR	TIM1 repetition counter register	0x00		

Table 11. General hardware register map (continued)

Address	Block	Register label	Register name	Reset status
0x00 5265	TIM1	TIM1_CCR1H	TIM1 capture/compare register 1 high	0x00
0x00 5266		TIM1_CCR1L	TIM1 capture/compare register 1 low	0x00
0x00 5267		TIM1_CCR2H	TIM1 capture/compare register 2 high	0x00
0x00 5268		TIM1_CCR2L	TIM1 capture/compare register 2 low	0x00
0x00 5269		TIM1_CCR3H	TIM1 capture/compare register 3 high	0x00
0x00 526A		TIM1_CCR3L	TIM1 capture/compare register 3 low	0x00
0x00 526B		TIM1_CCR4H	TIM1 capture/compare register 4 high	0x00
0x00 526C		TIM1_CCR4L	TIM1 capture/compare register 4 low	0x00
0x00 526D		TIM1_BKR	TIM1 break register	0x00
0x00 526E		TIM1_DTR	TIM1 dead-time register	0x00
0x00 526F		TIM1_OISR	TIM1 output idle state register	0x00
0x00 5270 to 0x00 52FF		Reserved area (147 bytes)		
0x00 5300	TIM2	TIM2_CR1	TIM2 control register 1	0x00
0x00 5301		TIM2_IER	TIM2 interrupt enable register	0x00
0x00 5302		TIM2_SR1	TIM2 status register 1	0x00
0x00 5303		TIM2_SR2	TIM2 status register 2	0x00
0x00 5304		TIM2_EGR	TIM2 event generation register	0x00
0x00 5305		TIM2_CCMR1	TIM2 capture/compare mode register 1	0x00
0x00 5306		TIM2_CCMR2	TIM2 capture/compare mode register 2	0x00
0x00 5307		TIM2_CCMR3	TIM2 capture/compare mode register 3	0x00
0x00 5308		TIM2_CCER1	TIM2 capture/compare enable register 1	0x00
0x00 5309		TIM2_CCER2	TIM2 capture/compare enable register 2	0x00
0x00 530A		TIM2_CNTRH	TIM2 counter high	0x00
0x00 530B		TIM2_CNTRL	TIM2 counter low	0x00
00 530C0x		TIM2_PSCR	TIM2 prescaler register	0x00
0x00 530D		TIM2_ARRH	TIM2 auto-reload register high	0xFF
0x00 530E		TIM2_ARRL	TIM2 auto-reload register low	0xFF
0x00 530F		TIM2_CCR1H	TIM2 capture/compare register 1 high	0x00
0x00 5310		TIM2_CCR1L	TIM2 capture/compare register 1 low	0x00
0x00 5311		TIM2_CCR2H	TIM2 capture/compare reg. 2 high	0x00
0x00 5312		TIM2_CCR2L	TIM2 capture/compare register 2 low	0x00
0x00 5313		TIM2_CCR3H	TIM2 capture/compare register 3 high	0x00

Table 11. General hardware register map (continued)

Address	Block	Register label	Register name	Reset status
0x00 5314	TIM2	TIM2_CCR3L	TIM2 capture/compare register 3 low	0x00
0x00 5315 to 0x00 531F	Reserved area (11 bytes)			
0x00 5320	TIM3	TIM3_CR1	TIM3 control register 1	0x00
0x00 5321		TIM3_IER	TIM3 interrupt enable register	0x00
0x00 5322		TIM3_SR1	TIM3 status register 1	0x00
0x00 5323		TIM3_SR2	TIM3 status register 2	0x00
0x00 5324		TIM3_EGR	TIM3 event generation register	0x00
0x00 5325		TIM3_CCMR1	TIM3 capture/compare mode register 1	0x00
0x00 5326		TIM3_CCMR2	TIM3 capture/compare mode register 2	0x00
0x00 5327		TIM3_CCER1	TIM3 capture/compare enable register 1	0x00
0x00 5328		TIM3_CNTRH	TIM3 counter high	0x00
0x00 5329		TIM3_CNTRL	TIM3 counter low	0x00
0x00 532A		TIM3_PSCR	TIM3 prescaler register	0x00
0x00 532B		TIM3_ARRH	TIM3 auto-reload register high	0xFF
0x00 532C		TIM3_ARRL	TIM3 auto-reload register low	0xFF
0x00 532D		TIM3_CCR1H	TIM3 capture/compare register 1 high	0x00
0x00 532E		TIM3_CCR1L	TIM3 capture/compare register 1 low	0x00
0x00 532F		TIM3_CCR2H	TIM3 capture/compare register 2 high	0x00
0x00 5330	TIM3_CCR2L	TIM3 capture/compare register 2 low	0x00	
0x00 5331 to 0x00 533F	Reserved area (15 bytes)			
0x00 5340	TIM4	TIM4_CR1	TIM4 control register 1	0x00
0x00 5341		TIM4_IER	TIM4 interrupt enable register	0x00
0x00 5342		TIM4_SR	TIM4 status register	0x00
0x00 5343		TIM4_EGR	TIM4 event generation register	0x00
0x00 5344		TIM4_CNTR	TIM4 counter	0x00
0x00 5345		TIM4_PSCR	TIM4 prescaler register	0x00
0x00 5346		TIM4_ARR	TIM4 auto-reload register	0xFF
0x00 5347 to 0x00 53DF	Reserved area (185 bytes)			

Table 11. General hardware register map (continued)

Address	Block	Register label	Register name	Reset status
0x00 53E0	ADC	ADC_DB0RH	ADC data buffer register 0 high	0x00
0x00 53E1		ADC_DB0RL	ADC data buffer register 0 low	0x00
0x00 53E2		ADC_DB1RH	ADC data buffer register 1 high	0x00
0x00 53E3		ADC_DB1RL	ADC data buffer register 1 low	0x00
0x00 53E4		ADC_DB2RH	ADC data buffer register 2 high	0x00
0x00 53E5		ADC_DB2RL	ADC data buffer register 2 low	0x00
0x00 53E6		ADC_DB3RH	ADC data buffer register 3 high	0x00
0x00 53E7		ADC_DB3RL	ADC data buffer register 3 low	0x00
0x00 53E8		ADC_DB4RH	ADC data buffer register 4 high	0x00
0x00 53E9		ADC_DB4RL	ADC data buffer register 4 low	0x00
0x00 53EA		ADC_DB5RH	ADC data buffer register 5 high	0x00
0x00 53EB		ADC_DB5RL	ADC data buffer register 5 low	0x00
0x00 53EC		ADC_DB6RH	ADC data buffer register 6 high	0x00
0x00 53ED		ADC_DB6RL	ADC data buffer register 6 low	0x00
0x00 53EE		ADC_DB7RH	ADC data buffer register 7 high	0x00
0x00 53EF		ADC_DB7RL	ADC data buffer register 7 low	0x00
0x00 53F0		ADC_DB8RH	ADC data buffer register 8 high	0x00
0x00 53F1		ADC_DB8RL	ADC data buffer register 8 low	0x00
0x00 53F2		ADC_DB9RH	ADC data buffer register 9 high	0x00
0x00 53F3		ADC_DB9RL	ADC data buffer register 9 low	0x00
0x00 53F4 to 0x00 53FF	Reserved area (12 bytes)			
0x00 5400	ADC	ADC_CSR	ADC control/status register	0x00
0x00 5401		ADC_CR1	ADC configuration register 1	0x00
0x00 5402		ADC_CR2	ADC configuration register 2	0x00
0x00 5403		ADC_CR3	ADC configuration register 3	0x00
0x00 5404		ADC_DRH	ADC data register high	0xXX
0x00 5405		ADC_DRL	ADC data register low	0xXX
0x00 5406		ADC_TDRH	ADC Schmitt trigger disable register high	0x00
0x00 5407		ADC_TDRL	ADC Schmitt trigger disable register low	0x00
0x00 5408		ADC_HTRH	ADC high threshold register high	0xFF
0x00 5409		ADC_HTRL	ADC high threshold register low	0x03
0x00 540A		ADC_LTRH	ADC low threshold register high	0x00

Table 11. General hardware register map (continued)

Address	Block	Register label	Register name	Reset status
0x00 540B	ADC	ADC_LTRL	ADC low threshold register low	0x00
0x00 540C		ADC_AWSRH	ADC watchdog status register high	0x00
0x00 540D		ADC_AWSRL	ADC watchdog status register low	0x00
0x00 540E		ADC_AWCRH	ADC watchdog control register high	0x00
0x00 540F		ADC_AWCRL	ADC watchdog control register low	0x00
0x00 5410 to 0x00 541F	Reserved area (16 bytes)			

1. Depends on the previous reset source.
2. Write only register.

Table 12. CPU/SWIM/debug module/interrupt controller registers

Address	Block	Register label	Register name	Reset status
0x00 7F00	CPU ⁽¹⁾	A	Accumulator	0x00
0x00 7F01		PCE	Program counter extended	0x00
0x00 7F02		PCH	Program counter high	0x80
0x00 7F03		PCL	Program counter low	0x00
0x00 7F04		XH	X index register high	0x00
0x00 7F05		XL	X index register low	0x00
0x00 7F06		YH	Y index register high	0x00
0x00 7F07		YL	Y index register low	0x00
0x00 7F08		SPH	Stack pointer high	0x17 ⁽²⁾
0x00 7F09		SPL	Stack pointer low	0xFF
0x00 7F0A		CC	Condition code register	0x28
0x00 7F0B to 0x00 7F5F	Reserved area (85 bytes)			
0x00 7F60	CPU	CFG_GCR	Global configuration register	0x00
0x00 7F70	ITC	ITC_SPR1	Interrupt software priority register 1	0xFF
0x00 7F71		ITC_SPR2	Interrupt software priority register 2	0xFF
0x00 7F72		ITC_SPR3	Interrupt software priority register 3	0xFF
0x00 7F73		ITC_SPR4	Interrupt software priority register 4	0xFF
0x00 7F74		ITC_SPR5	Interrupt software priority register 5	0xFF
0x00 7F75		ITC_SPR6	Interrupt software priority register 6	0xFF
0x00 7F76 to 0x00 7F79	Reserved area (4 bytes)			
0x00 7F80	SWIM	SWIM_CSR	SWIM control status register	0x00

Table 12. CPU/SWIM/debug module/interrupt controller registers (continued)

Address	Block	Register label	Register name	Reset status
0x00 7F81 to 0x00 7F8F	Reserved area (15 bytes)			
0x00 7F90	DM	DM_BK1RE	DM breakpoint 1 register extended byte	0xFF
0x00 7F91		DM_BK1RH	DM breakpoint 1 register high byte	0xFF
0x00 7F92		DM_BK1RL	DM breakpoint 1 register low byte	0xFF
0x00 7F93		DM_BK2RE	DM breakpoint 2 register extended byte	0xFF
0x00 7F94		DM_BK2RH	DM breakpoint 2 register high byte	0xFF
0x00 7F95		DM_BK2RL	DM breakpoint 2 register low byte	0xFF
0x00 7F96		DM_CR1	DM debug module control register 1	0x00
0x00 7F97		DM_CR2	DM debug module control register 2	0x00
0x00 7F98		DM_CSR1	DM debug module control/status register 1	0x10
0x00 7F99		DM_CSR2	DM debug module control/status register 2	0x00
0x00 7F9A		DM_ENFCTR	DM enable function register	0xFF
0x00 7F9B to 0x00 7F9F	Reserved area (5 bytes)			

1. Accessible by debug module only
2. Product dependent value, see [Figure 5: Register and memory map of STM8A products](#).

Table 13. Temporary memory unprotection registers

Address	Block	Register label	Register name	Reset status
0x00 5800	TMU	TMU_K1	Temporary memory unprotection key register 1	0x00
0x00 5801		TMU_K2	Temporary memory unprotection key register 2	0x00
0x00 5802		TMU_K3	Temporary memory unprotection key register 3	0x00
0x00 5803		TMU_K4	Temporary memory unprotection key register 4	0x00
0x00 5804		TMU_K5	Temporary memory unprotection key register 5	0x00
0x00 5805		TMU_K6	Temporary memory unprotection key register 6	0x00
0x00 5806		TMU_K7	Temporary memory unprotection key register 7	0x00
0x00 5807		TMU_K8	Temporary memory unprotection key register 8	0x00
0x00 5808		TMU_CSR	Temporary memory unprotection control and status register	0x00

8 Interrupt table

Table 14. STM8A interrupt table

Priority	Source block	Description	Interrupt vector address	Wakeup from Halt	Comments
-	Reset	Reset	0x00 8000	Yes	User RESET vector
-	TRAP	SW interrupt	0x00 8004	-	-
0	TLI	External top level interrupt	0x00 8008	-	-
1	AWU	Auto-wakeup from Halt	0x00 800C	Yes	-
2	Clock controller	Main clock controller	0x00 8010	-	-
3	MISC	Ext interrupt E0	0x00 8014	Yes	Port A interrupts
4	MISC	Ext interrupt E1	0x00 8018	Yes	Port B interrupts
5	MISC	Ext interrupt E2	0x00 801C	Yes	Port C interrupts
6	MISC	Ext interrupt E3	0x00 8020	Yes	Port D interrupts
7	MISC	Ext interrupt E4	0x00 8024	Yes	Port E interrupts
8	Reserved ⁽¹⁾	-	-	-	-
9	Reserved ⁽¹⁾	-	-	-	-
10	SPI	End of transfer	0x00 8030	Yes	-
11	Timer 1	Update/overflow/ trigger/break	0x00 8034	-	-
12	Timer 1	Capture/compare	0x00 8038	-	-
13	Timer 2	Update/overflow	0x00 803C	-	-
14	Timer 2	Capture/compare	0x00 8040	-	-
15	Timer 3	Update/overflow	0x00 8044	-	-
16	Timer 3	Capture/compare	0x00 8048	-	-
17	Reserved ⁽¹⁾	-	-	-	-
18	Reserved ⁽¹⁾	-	-	-	-
19	I ² C	I ² C interrupts	0x00 8054	Yes	-
20	LINUART	Tx complete/error	0x00 8058	-	-
21	LINUART	Receive data full reg.	0x00 805C	-	-
22	ADC	End of conversion	0x00 8060	-	-
23	Timer 4	Update/overflow	0x00 8064	-	-
24	EEPROM	End of Programming/ Write in not allowed area	0x00 8068	-	-

1. All reserved and unused interrupts must be initialized with 'IRET' for robust programming.

9 Option bytes

Option bytes contain configurations for device hardware features as well as the memory protection of the device. They are stored in a dedicated block of the memory. Each option byte has to be stored twice, for redundancy, in a regular form (OPTx) and a complemented one (NOPTx), except for the ROP (read-out protection) option byte and option bytes 8 to 16.

Option bytes can be modified in ICP mode (via SWIM) by accessing the EEPROM address shown in [Table 15: Option bytes](#) below.

Option bytes can also be modified 'on the fly' by the application in IAP mode, except the ROP and UBC options that can only be toggled in ICP mode (via SWIM).

Refer to the STM8 Flash programming manual (PM0051) and STM8 SWIM communication protocol and debug module user manual (UM0470) for information on SWIM programming procedures.

Table 15. Option bytes

Addr.	Option name	Option byte no.	Option bits								Factory default setting
			7	6	5	4	3	2	1	0	
0x00 4800	Read-out protection (ROP)	OPT0	ROP[7:0]								0x00
0x00 4801	User boot code (UBC)	OPT1	Reserved		UBC[5:0]						0x00
0x00 4802		NOPT1	Reserved		NUBC[5:0]						0xFF
0x00 4803	Alternate function remapping (AFR)	OPT2	AFR7	AFR6	AFR5	AFR4	AFR3	AFR2	AFR1	AFR0	0x00
0x00 4804		NOPT2	NAFR7	NAFR6	NAFR5	NAFR4	NAFR3	NAFR2	NAFR1	NAFR0	0xFF
0x00 4805	Watchdog option	OPT3	Reserved			16MHZ TRIM0	LSI_EN	IWDG_HW	WWDG_HW	WWDG_HALT	0x00
0x00 4806		NOPT3	Reserved			N16MHZ TRIM0	NLSI_EN	NIWDG_HW	NWWDG_HW	NWWDG_HALT	0xFF
0x00 4807	Clock option	OPT4	Reserved				EXT CLK	CKAWU SEL	PRSC1	PRSC0	0x00
0x00 4808		NOPT4	Reserved				NEXT CLK	NCKAWU SEL	NPRSC1	NPRSC0	0xFF
0x00 4809	HSE clock startup	OPT5	HSECNT[7:0]								0x00
0x00 480A		NOPT5	NHSECNT[7:0]								0xFF

Table 15. Option bytes (continued)

Addr.	Option name	Option byte no.	Option bits								Factory default setting
			7	6	5	4	3	2	1	0	
0x00 480B	TMU	OPT6	TMU[3:0]								0x00
0x00 480C		NOPT6	NTMU[3:0]								0xFF
0x00 480D	Flash wait states	OPT7	Reserved						WAIT STATE	0x00	
0x00 480E		NOPT7	Reserved						NWAIT STATE	0xFF	
0x00 480F	Reserved										
0x00 4810	TMU	OPT8	TMU_KEY 1 [7:0]								0x00
0x00 4811		OPT9	TMU_KEY 2 [7:0]								0x00
0x00 4812		OPT10	TMU_KEY 3 [7:0]								0x00
0x00 4813		OPT11	TMU_KEY 4 [7:0]								0x00
0x00 4814		OPT12	TMU_KEY 5 [7:0]								0x00
0x00 4815		OPT13	TMU_KEY 6 [7:0]								0x00
0x00 4816		OPT14	TMU_KEY 7 [7:0]								0x00
0x00 4817		OPT15	TMU_KEY 8 [7:0]								0x00
0x00 4818		OPT16	TMU_MAXATT [7:0]								0xC7
0x00 4819 to 487D		Reserved									
0x00 487E	Boot-loader ⁽¹⁾	OPT17	BL [7:0]								0x00
0x00 487F		NOPT17	NBL[7:0]								0xFF

1. This option consists of two bytes that must have a complementary value in order to be valid. If the option is invalid, it has no effect on EMC reset.

Table 16. Option byte description

Option byte no.	Description
OPT0	<p>ROP[7:0]: Memory readout protection (ROP) 0xAA: Enable readout protection (write access via SWIM protocol) <i>Note: Refer to STM8S series and STM8AF series 8-bit microcontrollers reference manual (RM0016) section on Flash/EEPROM memory readout protection for details.</i></p>
OPT1	<p>UBC[5:0]: User boot code area 0x00: No UBC, no write-protection 0x01: Page 0 to 1 defined as UBC, memory write-protected 0x02: Page 0 to 3 defined as UBC, memory write-protected 0x03 to 0x3F: Pages 4 to 63 defined as UBC, memory write-protected <i>Note: Refer to STM8S series and STM8AF series 8-bit microcontrollers reference manual (RM0016) section on Flash/EEPROM write protection for more details.</i></p>
OPT2	<p>AFR7: Alternate function remapping option 7 0: Port D4 alternate function = TIM2_CH1 1: Port D4 alternate function = BEEP</p> <p>AFR6: Alternate function remapping option 6 0: Port B5 alternate function = AIN5, port B4 alternate function = AIN4 1: Port B5 alternate function = I²C_SDA, port B4 alternate function = I²C_SCL.</p> <p>AFR5: Alternate function remapping option 5 0: Port B3 alternate function = AIN3, port B2 alternate function = AIN2, port B1 alternate function = AIN1, port B0 alternate function = AIN0. 1: Port B3 alternate function = TIM1_ETR, port B2 alternate function = TIM1_CH3N, port B1 alternate function = TIM1_CH2N, port B0 alternate function = TIM1_CH1N.</p> <p>AFR4: Alternate function remapping option 4 Reserved, bit must be kept at "0"</p> <p>AFR3: Alternate function remapping option 3 0: Port D0 alternate function = TIM3_CH2 1: Port D0 alternate function = TIM1_BKIN</p> <p>AFR2: Alternate function remapping option 2 0: Port D0 alternate function = TIM3_CH2 1: Port D0 alternate function = CLK_CCO <i>Note: AFR2 option has priority over AFR3 if both are activated</i></p> <p>AFR1: Alternate function remapping option 1 0: Port A3 alternate function = TIM2_CH3, port D2 alternate function = TIM3_CH1. 1: Port A3 alternate function = TIM3_CH1, port D2 alternate function = TIM2_CH3.</p> <p>AFR0: Alternate function remapping option 0 0: Port D3 alternate function = TIM2_CH2 1: Port D3 alternate function = ADC_ETR</p>

Table 16. Option byte description (continued)

Option byte no.	Description
OPT3	HSITRIM: Trimming option for 16 MHz internal RC oscillator 0: 3-bit on-the-fly trimming (compatible with devices based on the 128K silicon) 1: 4-bit on-the-fly trimming
	LSI_EN: Low speed internal clock enable 0: LSI clock is not available as CPU clock source 1: LSI clock is available as CPU clock source
	IWDG_HW: Independent watchdog 0: IWDG independent watchdog activated by software 1: IWDG independent watchdog activated by hardware
	WWDG_HW: Window watchdog activation 0: WWDG window watchdog activated by software 1: WWDG window watchdog activated by hardware
	WWDG_HALT: Window watchdog reset on Halt 0: No reset generated on Halt if WWDG active 1: Reset generated on Halt if WWDG active
OPT4	EXTCLK: External clock selection 0: External crystal connected to OSCIN/OSCOU 1: External clock signal on OSCIN
	CKAWUSEL: Auto-wakeup unit/clock 0: LSI clock source selected for AWU 1: HSE clock with prescaler selected as clock source for AWU
	PRSC[1:0]: AWU clock prescaler 00: Reserved 01: 16 MHz to 128 kHz prescaler 10: 8 MHz to 128 kHz prescaler 11: 4 MHz to 128 kHz prescaler
OPT5	HSECNT[7:0]: HSE crystal oscillator stabilization time This configures the stabilization time to 0.5, 8, 128, and 2048 HSE cycles with corresponding option byte values of 0xE1, 0xD2, 0xB4, and 0x00.
OPT6	TMU[3:0]: Enable temporary memory unprotection 0101: TMU disabled (permanent ROP). Any other value: TMU enabled.
OPT7	Reserved
OPT8	TMU_KEY 1 [7:0]: Temporary unprotection key 0 Temporary unprotection key: Must be different from 0x00 or 0xFF
OPT9	TMU_KEY 2 [7:0]: Temporary unprotection key 1 Temporary unprotection key: Must be different from 0x00 or 0xFF
OPT10	TMU_KEY 3 [7:0]: Temporary unprotection key 2 Temporary unprotection key: Must be different from 0x00 or 0xFF
OPT11	TMU_KEY 4 [7:0]: Temporary unprotection key 3 Temporary unprotection key: Must be different from 0x00 or 0xFF

Table 16. Option byte description (continued)

Option byte no.	Description
OPT12	TMU_KEY 5 [7:0]: Temporary unprotection key 4 Temporary unprotection key: Must be different from 0x00 or 0xFF
OPT13	TMU_KEY 6 [7:0]: Temporary unprotection key 5 Temporary unprotection key: Must be different from 0x00 or 0xFF
OPT14	TMU_KEY 7 [7:0]: Temporary unprotection key 6 Temporary unprotection key: Must be different from 0x00 or 0xFF
OPT15	TMU_KEY 8 [7:0]: Temporary unprotection key 7 Temporary unprotection key: Must be different from 0x00 or 0xFF
OPT16	TMU_MAXATT [7:0]: TMU access failure counter TMU_MAXATT can be initialized with the desired value only if TMU is disabled (TMU[3:0]=0101 in OPT6 option byte). When TMU is enabled, any attempt to temporarily remove the readout protection by using wrong key values increments the counter. When the option byte value reaches 0x08, the Flash memory and data EEPROM are erased.
OPT17	BL [7:0]: Bootloader enable If this option byte is set to 0x55 (complementary value 0xAA) the bootloader program is activated also in case of a programmed code memory (for more details, see the bootloader user manual, UM0560).

10 Electrical characteristics

10.1 Parameter conditions

Unless otherwise specified, all voltages are referred to V_{SS} .

10.1.1 Minimum and maximum values

Unless otherwise specified the minimum and maximum values are guaranteed in the worst conditions of ambient temperature, supply voltage and frequencies by tests in production on 100% of the devices with an ambient temperature at $T_A = -40\text{ }^\circ\text{C}$, $T_A = 25\text{ }^\circ\text{C}$, and $T_A = T_{Amax}$ (given by the selected temperature range).

Data based on characterization results, design simulation and/or technology characteristics are indicated in the table footnotes and are not tested in production.

10.1.2 Typical values

Unless otherwise specified, typical data are based on $T_A = 25\text{ }^\circ\text{C}$, $V_{DD} = 5.0\text{ V}$. They are given only as design guidelines and are not tested.

Typical ADC accuracy values are determined by characterization of a batch of samples from a standard diffusion lot over the full temperature range.

10.1.3 Typical curves

Unless otherwise specified, all typical curves are given only as design guidelines and are not tested.

10.1.4 Loading capacitor

The loading conditions used for pin parameter measurement are shown in [Figure 6](#).

Figure 6. Pin loading conditions



10.1.5 Pin input voltage

The input voltage measurement on a pin of the device is described in [Figure 7](#).

Figure 7. Pin input voltage



10.2 Absolute maximum ratings

Stresses above those listed as ‘absolute maximum ratings’ may cause permanent damage to the device. This is a stress rating only and functional operation of the device under these conditions is not implied. Exposure to maximum rating conditions for extended periods may affect device reliability.

Table 17. Voltage characteristics

Symbol	Ratings	Min	Max	Unit
$V_{DDx} - V_{SS}$	Supply voltage (including V_{DDA} and V_{DDIO}) ⁽¹⁾	-0.3	6.5	V
V_{IN}	Input voltage on true open drain pins (PE1, PE2) ⁽²⁾	$V_{SS} - 0.3$	6.5	V
	Input voltage on any other pin ⁽²⁾	$V_{SS} - 0.3$	$V_{DD} + 0.3$	
$ V_{DDx} - V_{DD} $	Variations between different power pins	-	50	mV
$ V_{SSx} - V_{SS} $	Variations between all the different ground pins	-	50	
V_{ESD}	Electrostatic discharge voltage	see Absolute maximum ratings (electrical sensitivity) on page 76		

1. All power (V_{DD} , V_{DDIO} , V_{DDA}) and ground (V_{SS} , V_{SSIO} , V_{SSA}) pins must always be connected to the external power supply
2. $I_{INJ(PIN)}$ must never be exceeded. This is implicitly insured if V_{IN} maximum is respected. If V_{IN} maximum cannot be respected, the injection current must be limited externally to the $I_{INJ(PIN)}$ value. A positive injection is induced by $V_{IN} > V_{DD}$ while a negative injection is induced by $V_{IN} < V_{SS}$. For true open-drain pads, there is no positive injection current, and the corresponding V_{IN} maximum must always be respected

Table 18. Current characteristics

Symbol	Ratings	Max.	Unit
I_{VDDIO}	Total current into V_{DDIO} power lines (source) ⁽¹⁾⁽²⁾⁽³⁾	100	mA
I_{VSSIO}	Total current out of V_{SSIO} ground lines (sink) ⁽¹⁾⁽²⁾⁽³⁾	100	
I_{IO}	Output current sunk by any I/O and control pin	20	
	Output current source by any I/Os and control pin	-20	
$I_{INJ(PIN)}^{(4)}$	Injected current on any pin	±10	
$I_{INJ(TOT)}$	Sum of injected currents	50	

1. All power (V_{DD} , V_{DDIO} , V_{DDA}) and ground (V_{SS} , V_{SSIO} , V_{SSA}) pins must always be connected to the external supply.
2. The total limit applies to the sum of operation and injected currents.
3. V_{DDIO} includes the sum of the positive injection currents. V_{SSIO} includes the sum of the negative injection currents.
4. This condition is implicitly insured if V_{IN} maximum is respected. If V_{IN} maximum cannot be respected, the injection current must be limited externally to the $I_{INJ(PIN)}$ value. A positive injection is induced by $V_{IN} > V_{DD}$ while a negative injection is induced by $V_{IN} < V_{SS}$. For true open-drain pads, there is no positive injection current allowed and the corresponding V_{IN} maximum must always be respected.

Table 19. Thermal characteristics

Symbol	Ratings	Value	Unit
T_{STG}	Storage temperature range	-65 to 150	°C
T_J	Maximum junction temperature	160	

Table 20. Operating lifetime⁽¹⁾

Symbol	Ratings	Value	Unit
OLF	Conforming to AEC-Q100 rev G	-40 to 125 °C	Grade 1
		-40 to 150 °C	Grade 0

1. For detailed mission profile analysis, please contact the nearest local ST Sales Office.

10.3 Operating conditions

Table 21. General operating conditions

Symbol	Parameter	Conditions	Min	Max	Unit
f_{CPU}	Internal CPU clock frequency	$T_A = -40\text{ °C to }150\text{ °C}$	0	16	MHz
V_{DD}/V_{DDIO}	Standard operating voltage	-	3.0	5.5	V
$V_{CAP}^{(1)}$	C_{EXT} : capacitance of external capacitor	-	470	3300	nF
	ESR of external capacitor	at 1 MHz ⁽²⁾	-	0.3	Ω
	ESL of external capacitor		-	15	nH
P_D	Power dissipation (all temperature ranges)	LQFP32	-	85	mW
		VFQFPN32	-	200	
		LQFP48	-	88	
T_A	Ambient temperature	Suffix A	-40	85	$^{\circ}\text{C}$
		Suffix C		125	
		Suffix D		150	
T_J	Junction temperature range	Suffix A		90	
		Suffix C		130	
		Suffix D		155	

- Care should be taken when selecting the capacitor, due to its tolerance, as well as the parameter dependency on temperature, DC bias and frequency in addition to other factors. The parameter maximum value must be respected for the full application range.
- This frequency of 1 MHz as a condition for V_{CAP} parameters is given by design of internal regulator.

Figure 8. f_{CPUmax} versus V_{DD}



Table 22. Operating conditions at power-up/power-down

Symbol	Parameter	Conditions	Min	Typ	Max	Unit
t_{VDD}	V_{DD} rise time rate	-	2 ⁽¹⁾	-	∞	$\mu\text{s/V}$
	V_{DD} fall time rate	-	2 ⁽¹⁾	-	∞	
t_{TEMP}	Reset release delay	V_{DD} rising	-	1	1.7	ms
	Reset generation delay	V_{DD} falling	-	3	-	μs
V_{IT+}	Power-on reset threshold ^{(2) (3)}	-	2.65	2.8	2.95	V
V_{IT-}	Brown-out reset threshold	-	2.58	2.73	2.88	
$V_{HYS(BOR)}$	Brown-out reset hysteresis	-	-	70 ⁽¹⁾	-	mV

1. Guaranteed by design, not tested in production
2. If V_{DD} is below 3 V, the code execution is guaranteed above the V_{IT-} and V_{IT+} thresholds. RAM content is kept. The EEPROM programming sequence must not be initiated.
3. There is inrush current into V_{DD} present after device power on to charge C_{EXT} capacitor. This inrush energy depends from C_{EXT} capacitor value. For example, a C_{EXT} of 1 μF requires $Q=1 \mu\text{F} \times 1.8\text{V} = 1.8 \mu\text{C}$.

10.3.1 VCAP external capacitor

Stabilization for the main regulator is achieved connecting an external capacitor C_{EXT} to the V_{CAP} pin. C_{EXT} is specified in [Table 21](#). Care should be taken to limit the series inductance to less than 15 nH.

Figure 9. External capacitor C_{EXT}



1. Legend: ESR is the equivalent series resistance and ESL is the equivalent inductance.

10.3.2 Supply current characteristics

The current consumption is measured as described in [Figure 6 on page 49](#) and [Figure 7 on page 50](#).

If not explicitly stated, general conditions of temperature and voltage apply.

Table 23. Total current consumption in Run, Wait and Slow mode.
General conditions for V_{DD} apply, $T_A = -40$ to 150 °C

Symbol	Parameter	Conditions	Typ	Max	Unit	
$I_{DD(RUN)}^{(1)}$	Supply current in Run mode	All peripherals clocked, code executed from Flash program memory, HSE external clock (without resonator)	$f_{CPU} = 16$ MHz	7.4	14	mA
			$f_{CPU} = 8$ MHz	4.0	7.4 ⁽²⁾	
			$f_{CPU} = 4$ MHz	2.4	4.1 ⁽²⁾	
			$f_{CPU} = 2$ MHz	1.5	2.5	
$I_{DD(RUN)}^{(1)}$	Supply current in Run mode	All peripherals clocked, code executed from RAM and EEPROM, HSE external clock (without resonator)	$f_{CPU} = 16$ MHz	3.7	5.0	
			$f_{CPU} = 8$ MHz	2.2	3.0 ⁽²⁾	
			$f_{CPU} = 4$ MHz	1.4	2.0 ⁽²⁾	
			$f_{CPU} = 2$ MHz	1.0	1.5	
$I_{DD(WFI)}^{(1)}$	Supply current in Wait mode	CPU stopped, all peripherals off, HSE external clock	$f_{CPU} = 16$ MHz	1.65	2.5	
			$f_{CPU} = 8$ MHz	1.15	1.9 ⁽²⁾	
			$f_{CPU} = 4$ MHz	0.90	1.6 ⁽²⁾	
			$f_{CPU} = 2$ MHz	0.80	1.5	
$I_{DD(SLOW)}^{(1)}$	Supply current in Slow mode	f_{CPU} scaled down, all peripherals off, code executed from RAM	Ext. clock 16 MHz $f_{CPU} = 125$ kHz	1.50	1.95	
			LSI internal RC $f_{CPU} = 128$ kHz	1.50	1.80 ⁽²⁾	

1. The current due to I/O utilization is not taken into account in these values.

2. Values not tested in production. Design guidelines only.

Table 24. Total current consumption in Halt and Active-halt modes.
General conditions for V_{DD} apply, T_A = -40 to 55 °C

Symbol	Parameter	Conditions			Typ	Max	Unit
		Main voltage regulator (MVR) ⁽¹⁾	Flash mode ⁽²⁾	Clock source and specific temperature condition			
I _{DD(H)}	Supply current in Halt mode	Off	Power-down	Clocks stopped	5	35 ⁽³⁾	
				Clocks stopped, T _A = 25 °C	5	25	
I _{DD(AH)}	Supply current in Active-halt mode with regulator on	On	Power-down	Ext. clock 16 MHz f _{MASTER} = 125 kHz	770	900 ⁽³⁾	μA
				LSI clock 128 kHz	150	230 ⁽³⁾	
	Supply current in Active-halt mode with regulator off	Off	Power-down	LSI clock 128 kHz	25	42 ⁽³⁾	
				LSI clock 128 kHz, T _A = 25 °C	25	30	
t _{WU(AH)}	Wakeup time from Active-halt mode with regulator on	On	Operating mode	T _A = -40 to 150 °C	10	30 ⁽³⁾	μs
	Wakeup time from Active-halt mode with regulator off	Off			50	80 ⁽³⁾	

1. Configured by the REGAH bit in the CLK_ICKR register.
2. Configured by the AHALT bit in the FLASH_CR1 register.
3. Data based on characterization results. Not tested in production.

Current consumption for on-chip peripherals

Table 25. Oscillator current consumption

Symbol	Parameter	Conditions		Typ	Max ⁽¹⁾	Unit
I _{DD(OSC)}	HSE oscillator current consumption ⁽²⁾	Quartz or ceramic resonator, CL = 33 pF V _{DD} = 5 V	f _{OSC} = 24 MHz	1	2.0 ⁽³⁾	mA
			f _{OSC} = 16 MHz	0.6	-	
			f _{OSC} = 8 MHz	0.57	-	
		Quartz or ceramic resonator, CL = 33 pF V _{DD} = 3.3 V	f _{OSC} = 24 MHz	0.5	1.0 ⁽³⁾	
			f _{OSC} = 16 MHz	0.25	-	
			f _{OSC} = 8 MHz	0.18	-	

1. During startup, the oscillator current consumption may reach 6 mA.
2. The supply current of the oscillator can be further optimized by selecting a high quality resonator with small R_m value. Refer to crystal manufacturer for more details
3. Informative data.

Table 26. Programming current consumption

Symbol	Parameter	Conditions	Typ	Max	Unit
$I_{DD(PROG)}$	Programming current	$V_{DD} = 5\text{ V}$, $-40\text{ }^{\circ}\text{C}$ to $150\text{ }^{\circ}\text{C}$, erasing and programming data or Flash program memory	1.0	1.7	mA

Table 27. Typical peripheral current consumption $V_{DD} = 5.0\text{ V}^{(1)}$

Symbol	Parameter	Typ. $f_{master} = 2\text{ MHz}$	Typ. $f_{master} = 16\text{ MHz}$	Unit
$I_{DD(TIM1)}$	TIM1 supply current ⁽²⁾	0.03	0.23	mA
$I_{DD(TIM2)}$	TIM2 supply current ⁽²⁾	0.02	0.12	
$I_{DD(TIM3)}$	TIM3 supply current ⁽²⁾	0.01	0.1	
$I_{DD(TIM4)}$	TIM4 supply current ⁽²⁾	0.004	0.03	
$I_{DD(LINUART)}$	LINUART supply current ⁽²⁾	0.03	0.11	
$I_{DD(SPI)}$	SPI supply current ⁽²⁾	0.01	0.04	
$I_{DD(I^2C)}$	I ² C supply current ⁽²⁾	0.02	0.06	
$I_{DD(AWU)}$	AWU supply current ⁽²⁾	0.003	0.02	
$I_{DD(TOT_DIG)}$	All digital peripherals on	0.22	1	
$I_{DD(ADC)}$	ADC supply current when converting ⁽³⁾	0.93	0.95	

1. Typical values not tested in production. Since the peripherals are powered by an internally regulated, constant digital supply voltage, the values are similar in the full supply voltage range.
2. Data based on a differential I_{DD} measurement between no peripheral clocked and a single active peripheral. This measurement does not include the pad toggling consumption.
3. Data based on a differential I_{DD} measurement between reset configuration and continuous A/D conversions.

Current consumption curves

Figure 10 to Figure 15 show typical current consumption measured with code executing in RAM.

Figure 10. Typ. $I_{DD(RUN)HSE}$ vs. V_{DD} @ $f_{CPU} = 16\text{ MHz}$, peripheral = on

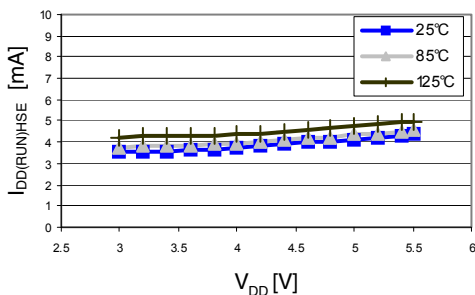
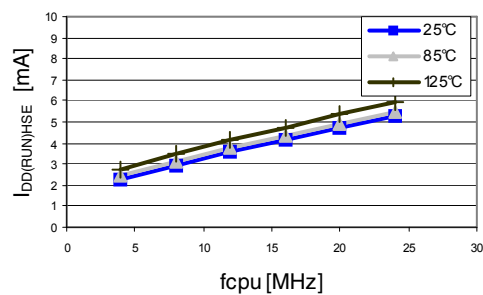
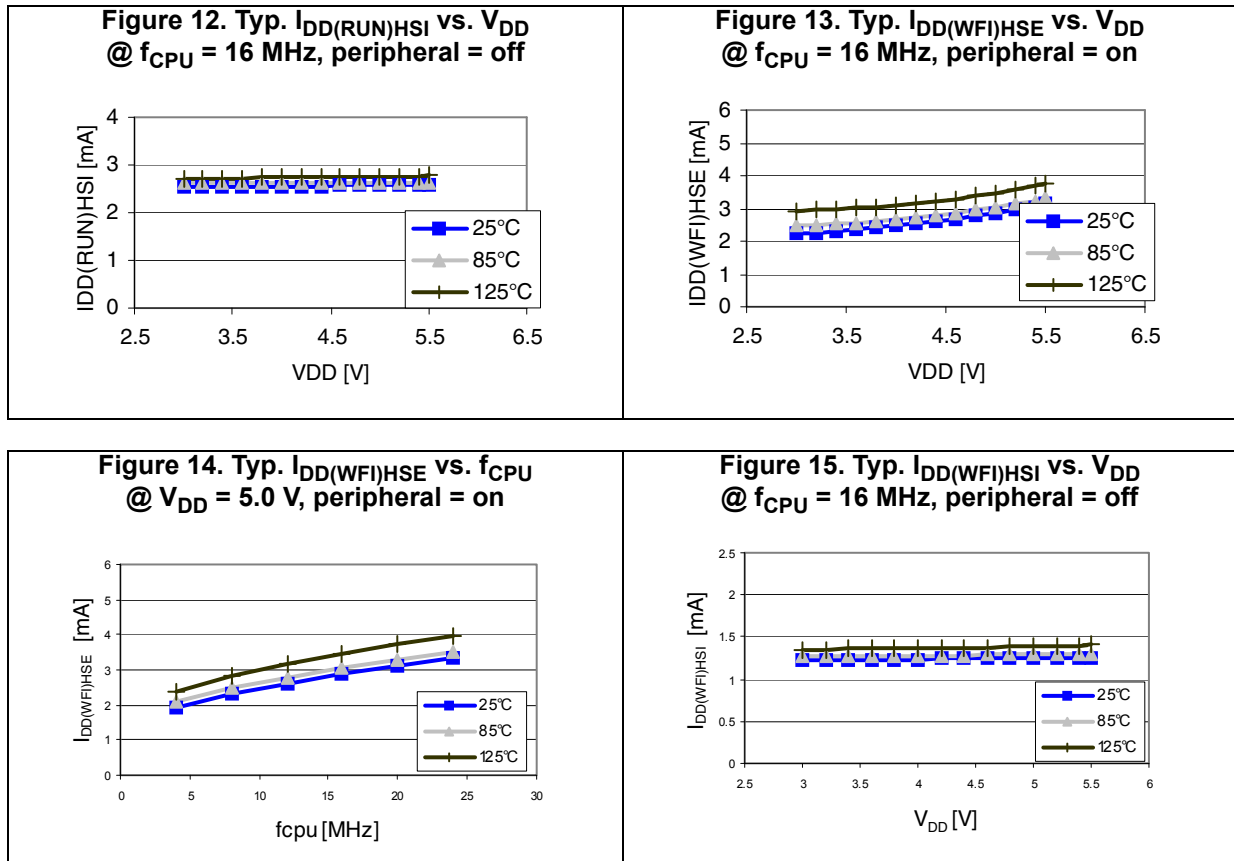

Figure 11. Typ. $I_{DD(RUN)HSE}$ vs. f_{CPU} @ $V_{DD} = 5.0\text{ V}$, peripheral = on





10.3.3 External clock sources and timing characteristics

HSE user external clock

Subject to general operating conditions for V_{DD} and T_A .

Table 28. HSE user external clock characteristics

Symbol	Parameter	Conditions	Min	Typ	Max	Unit
f_{HSE_ext}	User external clock source frequency	T_A is -40 to 150 °C	0 ⁽¹⁾	-	16	MHz
V_{HSEdHL}	Comparator hysteresis	-	$0.1 \times V_{DD}$	-	-	V
V_{HSEH}	OSCIN input pin high level voltage	-	$0.7 \times V_{DD}$	-	V_{DD}	
V_{HSEL}	OSCIN input pin low level voltage	-	V_{SS}	-	$0.3 \times V_{DD}$	
I_{LEAK_HSE}	OSCIN input leakage current	$V_{SS} < V_{IN} < V_{DD}$	-1	-	+1	μA

1. In CSS is used, the external clock must have a frequency above 500 kHz.

Figure 16. HSE external clock source



HSE crystal/ceramic resonator oscillator

The HSE clock can be supplied using a crystal/ceramic resonator oscillator of up to 16 MHz. All the information given in this paragraph is based on characterization results with specified typical external components. In the application, the resonator and the load capacitors have to be placed as close as possible to the oscillator pins in order to minimize output distortion and startup stabilization time. Refer to the crystal resonator manufacturer for more details (frequency, package, accuracy...).

Table 29. HSE oscillator characteristics

Symbol	Parameter	Conditions	Min	Typ	Max	Unit
R _F	Feedback resistor	-	-	220	-	kΩ
C _{L1} /C _{L2} ⁽¹⁾	Recommended load capacitance	-	-	-	20	pF
g _m	Oscillator transconductance	-	5	-	-	mA/V
t _{SU(HSE)} ⁽²⁾	Startup time	V _{DD} is stabilized	-	2.8	-	ms

1. The oscillator needs two load capacitors, C_{L1} and C_{L2}, to act as load for the crystal. The total load capacitance (C_{load}) is (C_{L1} * C_{L2})/(C_{L1} + C_{L2}). If C_{L1} = C_{L2}, C_{load} = C_{L1} / 2. Some oscillators have built-in load capacitors, C_{L1} and C_{L2}.
2. This value is the startup time, measured from the moment it is enabled (by software) until a stabilized 16 MHz oscillation is reached. It can vary with the crystal type that is used.

Figure 17. HSE oscillator circuit diagram



HSE oscillator critical gm formula

The crystal characteristics have to be checked with the following formula:

$$g_m \gg g_{m\text{crit}}$$

where $g_{m\text{crit}}$ can be calculated with the crystal parameters as follows:

$$g_{m\text{crit}} = (2 \times \pi \times f_{\text{HSE}})^2 \times R_m(2C_o + C)^2$$

- R_m : Notional resistance (see crystal specification)
- L_m : Notional inductance (see crystal specification)
- C_m : Notional capacitance (see crystal specification)
- C_o : Shunt capacitance (see crystal specification)
- $C_{L1} = C_{L2} = C$: Grounded external capacitance

10.3.4 Internal clock sources and timing characteristics

Subject to general operating conditions for V_{DD} and T_A .

High speed internal RC oscillator (HSI)

Table 30. HSI oscillator characteristics

Symbol	Parameter	Conditions	Min	Typ	Max	Unit
f_{HSI}	Frequency	-	-	16	-	MHz

Table 30. HSI oscillator characteristics

Symbol	Parameter	Conditions	Min	Typ	Max	Unit
ACC _{HS}	HSI oscillator user trimming accuracy	Trimmed by the application for any V _{DD} and T _A conditions	-1 ⁽¹⁾	-	1 ⁽¹⁾	%
			-0.5 ⁽¹⁾	-	0.5 ⁽¹⁾	
ACC _{HS}	HSI oscillator accuracy (factory calibrated)	3.0 V ≤ V _{DD} ≤ 5.5 V, -40 °C ≤ T _A ≤ 150 °C	-5	-	5	
		3.0V ≤ V _{DD} ≤ 5.5V, -40°C ≤ T _A ≤ 125 °C	-2.5 ⁽²⁾	-	2.5 ⁽²⁾	
t _{su(HSI)}	HSI oscillator wakeup time	-	-	-	2 ⁽³⁾	µs

1. Depending on option byte setting (OPT3 and NOPT3)
2. These values are guaranteed for STM8AF62x6ITx order codes only.
3. Guaranteed by characterization, not tested in production

Figure 18. Typical HSI frequency vs V_{DD}



Low speed internal RC oscillator (LSI)

Subject to general operating conditions for V_{DD} and T_A.

Table 31. LSI oscillator characteristics

Symbol	Parameter	Conditions	Min	Typ	Max	Unit
f _{LSI}	Frequency	-	112	128	144	kHz
t _{su(LSI)}	LSI oscillator wakeup time	-	-	-	7 ⁽¹⁾	µs

1. Data based on characterization results, not tested in production.

Figure 19. Typical LSI frequency vs V_{DD}



10.3.5 Memory characteristics

Flash program memory/data EEPROM memory

General conditions: $T_A = -40$ to 150 °C.

Table 32. Flash program memory/data EEPROM memory

Symbol	Parameter	Conditions	Min	Typ	Max	Unit
V_{DD}	Operating voltage (all modes, execution/write/erase)	f_{CPU} is 0 to 16 MHz with 0 ws	3.0	-	5.5	V
V_{DD}	Operating voltage (code execution)	f_{CPU} is 0 to 16 MHz with 0 ws	2.6	-	5.5	
t_{prog}	Standard programming time (including erase) for byte/word/block (1 byte/4 bytes/128 bytes)	-	-	6	6.6	ms
	Fast programming time for 1 block (128 bytes)	-	-	3	3.3	
t_{erase}	Erase time for 1 block (128 bytes)	-	-	3	3.3	

Table 33. Flash program memory

Symbol	Parameter	Condition	Min	Max	Unit
T_{WE}	Temperature for writing and erasing	-	-40	150	°C
N_{WE}	Flash program memory endurance (erase/write cycles) ⁽¹⁾	$T_A = 25$ °C	1000	-	cycles
t_{RET}	Data retention time	$T_A = 25$ °C	40	-	years
		$T_A = 55$ °C	20	-	

1. The physical granularity of the memory is four bytes, so cycling is performed on four bytes even when a write/erase operation addresses a single byte.

Table 34. Data memory

Symbol	Parameter	Condition	Min	Max	Unit
T_{WE}	Temperature for writing and erasing	-	-40	150	°C
N_{WE}	Data memory endurance ⁽¹⁾ (erase/write cycles)	$T_A = 25$ °C	300 k	-	cycles
		$T_A = -40$ °C to 125 °C	100 k ⁽²⁾	-	
t_{RET}	Data retention time	$T_A = 25$ °C	40 ⁽²⁾⁽³⁾	-	years
		$T_A = 55$ °C	20 ⁽²⁾⁽³⁾	-	

1. The physical granularity of the memory is four bytes, so cycling is performed on four bytes even when a write/erase operation addresses a single byte.
2. More information on the relationship between data retention time and number of write/erase cycles is available in a separate technical document.
3. Retention time for 256B of data memory after up to 1000 cycles at 125 °C.

10.3.6 I/O port pin characteristics

General characteristics

Subject to general operating conditions for V_{DD} and T_A unless otherwise specified. All unused pins must be kept at a fixed voltage, using the output mode of the I/O for example or an external pull-up or pull-down resistor.

Table 35. I/O static characteristics

Symbol	Parameter	Conditions	Min	Typ	Max	Unit
V_{IL}	Input low level voltage	-	-0.3 V	-	$0.3 \times V_{DD}$	V
V_{IH}	Input high level voltage		$0.7 \times V_{DD}$	-	$V_{DD} + 0.3 V$	
V_{hys}	Hysteresis ⁽¹⁾		-	$0.1 \times V_{DD}$	-	
V_{OH}	Output high level voltage	Standard I/O, $V_{DD} = 5 V$, $I = 3 mA$	$V_{DD} - 0.5 V$	-	-	V
		Standard I/O, $V_{DD} = 3 V$, $I = 1.5 mA$	$V_{DD} - 0.4 V$	-	-	
V_{OL}	Output low level voltage	High sink and true open drain I/O, $V_{DD} = 5 V$ $I = 8 mA$	-	-	0.5	V
		Standard I/O, $V_{DD} = 5 V$ $I = 3 mA$	-	-	0.6	
		Standard I/O, $V_{DD} = 3 V$ $I = 1.5 mA$	-	-	0.4	
R_{pu}	Pull-up resistor	$V_{DD} = 5 V, V_{IN} = V_{SS}$	35	50	65	k Ω
t_R, t_F	Rise and fall time (10% - 90%)	Fast I/Os Load = 50 pF	-	-	35 ⁽²⁾	ns
		Standard and high sink I/Os Load = 50 pF	-	-	125 ⁽²⁾	
		Fast I/Os Load = 20 pF	-	-	20 ⁽²⁾	
		Standard and high sink I/Os Load = 20 pF	-	-	50 ⁽²⁾	
I_{lkg}	Digital input pad leakage current	$V_{SS} \leq V_{IN} \leq V_{DD}$	-	-	± 1	μA
$I_{lkg\ ana}$	Analog input pad leakage current	$V_{SS} \leq V_{IN} \leq V_{DD}$ $-40\ ^\circ C < T_A < 125\ ^\circ C$	-	-	± 250	nA
		$V_{SS} \leq V_{IN} \leq V_{DD}$ $-40\ ^\circ C < T_A < 150\ ^\circ C$	-	-	± 500	
$I_{lkg(inj)}$	Leakage current in adjacent I/O ⁽³⁾	Injection current $\pm 4 mA$	-	-	± 1 ⁽³⁾	μA
I_{DDIO}	Total current on either V_{DDIO} or V_{SSIO}	Including injection currents	-	-	60	mA

1. Hysteresis voltage between Schmitt trigger switching levels. Based on characterization results, not tested in production.

- 2. Guaranteed by design.
- 3. Data based on characterization results, not tested in production.

Figure 20. Typical V_{IL} and V_{IH} vs V_{DD} @ four temperatures



Figure 21. Typical pull-up resistance R_{PU} vs V_{DD} @ four temperatures



Figure 22. Typical pull-up current I_{PU} vs V_{DD} @ four temperatures



Typical output level curves

Figure 23 to Figure 32 show typical output level curves measured with output on a single pin.

Figure 23. Typ. V_{OL} @ $V_{DD} = 3.3$ V (standard ports)

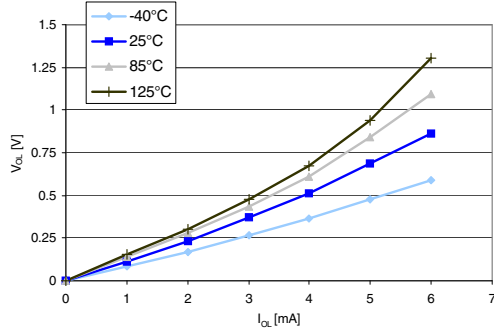

Figure 24. Typ. V_{OL} @ $V_{DD} = 5.0$ V (standard ports)

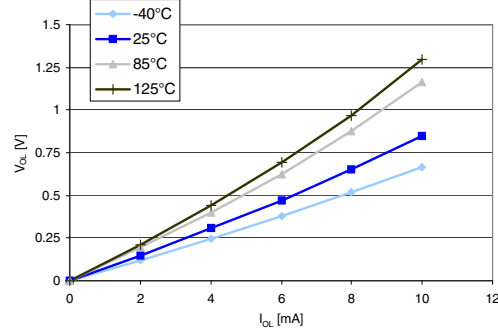

Figure 25. Typ. V_{OL} @ $V_{DD} = 3.3$ V (true open drain ports)

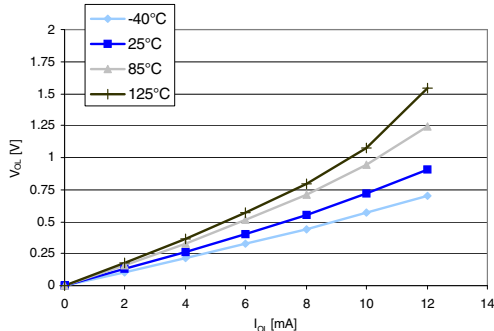

Figure 26. Typ. V_{OL} @ $V_{DD} = 5.0$ V (true open drain ports)

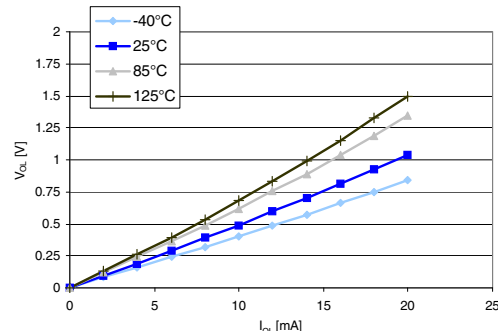

Figure 27. Typ. V_{OL} @ $V_{DD} = 3.3$ V (high sink ports)



Figure 28. Typ. V_{OL} @ $V_{DD} = 5.0$ V (high sink ports)

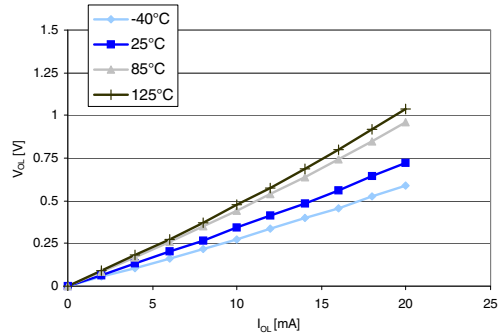

Figure 29. Typ. $V_{DD} - V_{OH}$ @ $V_{DD} = 3.3$ V (standard ports)



Figure 30. Typ. $V_{DD} - V_{OH}$ @ $V_{DD} = 5.0$ V (standard ports)

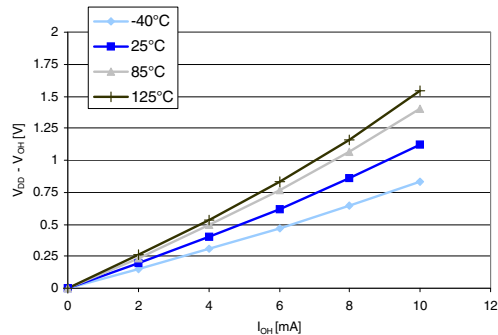
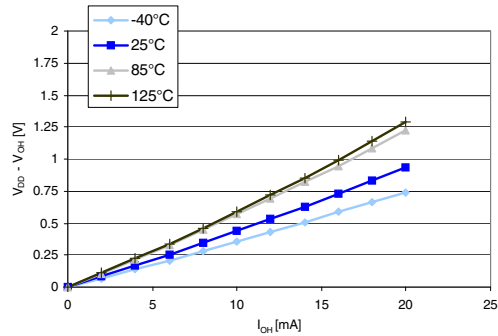

Figure 31. Typ. $V_{DD} - V_{OH}$ @ $V_{DD} = 3.3$ V (high sink ports)



Figure 32. Typ. $V_{DD} - V_{OH}$ @ $V_{DD} = 5.0$ V (high sink ports)



10.3.7 Reset pin characteristics

Subject to general operating conditions for V_{DD} and T_A unless otherwise specified.

Table 36. NRST pin characteristics

Symbol	Parameter	Conditions	Min	Typ	Max	Unit
$V_{IL(NRST)}$	NRST input low level voltage ⁽¹⁾	-	V_{SS}	-	$0.3 \times V_{DD}$	V
$V_{IH(NRST)}$	NRST input high level voltage ⁽¹⁾	-	$0.7 \times V_{DD}$	-	V_{DD}	
$V_{OL(NRST)}$	NRST output low level voltage ⁽¹⁾	$I_{OL} = 3 \text{ mA}$	-	-	0.6	
$R_{PU(NRST)}$	NRST pull-up resistor	-	30	40	60	k Ω
t_{IFP}	NRST input filtered pulse ⁽¹⁾	-	85	-	315	ns
$t_{INFP(NRST)}$	NRST Input not filtered pulse duration ⁽²⁾	-	500	-	-	

1. Data based on characterization results, not tested in production.
2. Data guaranteed by design, not tested in production.

Figure 33. Typical NRST V_{IL} and V_{IH} vs V_{DD} @ four temperatures

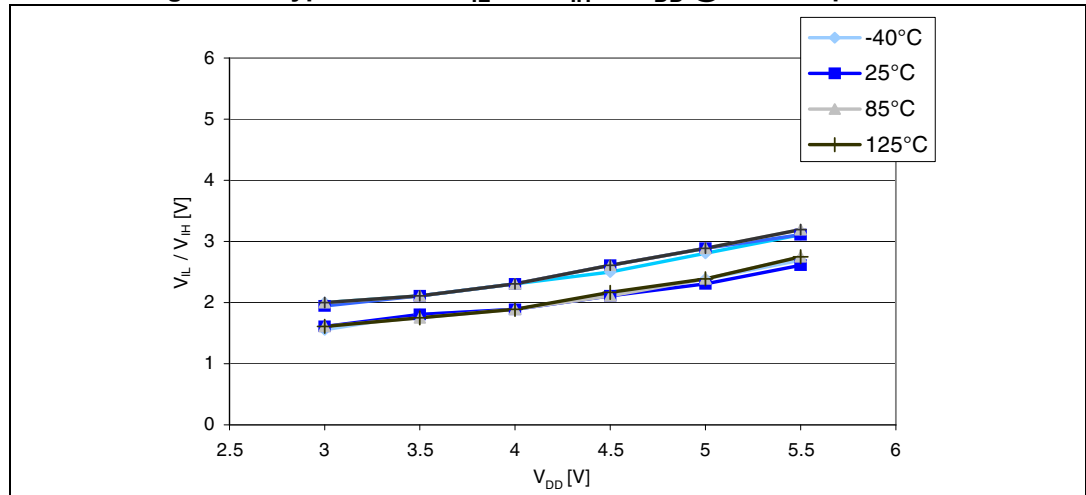

Figure 34. Typical NRST pull-up resistance R_{PU} vs V_{DD}



Figure 35. Typical NRST pull-up current I_{PU} vs V_{DD}



The reset network shown in [Figure 36](#) protects the device against parasitic resets. The user must ensure that the level on the NRST pin can go below $V_{IL(NRST)}$ max (see [Table 36: NRST pin characteristics](#)), otherwise the reset is not taken into account internally.

Figure 36. Recommended reset pin protection



10.3.8 TIM 1, 2, 3, and 4 timer specifications

Subject to general operating conditions for V_{DD} , f_{MASTER} , and T_A unless otherwise specified.

Table 37. TIM 1, 2, 3, and 4 electrical specifications

Symbol	Parameter	Conditions	Min	Typ	Max	Unit
f_{EXT}	Timer external clock frequency ⁽¹⁾	-	-	-	16	MHz

1. Not tested in production. On 64 Kbyte devices, the frequency is limited to 16 MHz.

10.3.9 SPI serial peripheral interface

Unless otherwise specified, the parameters given in [Table 38](#) are derived from tests performed under ambient temperature, f_{MASTER} frequency and V_{DD} supply voltage conditions. $t_{MASTER} = 1/f_{MASTER}$.

Refer to I/O port characteristics for more details on the input/output alternate function characteristics (NSS, SCK, MOSI, MISO).

Table 38. SPI characteristics

Symbol	Parameter	Conditions	Min	Max	Unit	
f_{SCK} $1/t_{c(SCK)}$	SPI clock frequency	Master mode	0	10	MHz	
		Slave mode	$V_{DD} < 4.5 V$	0		6 ⁽¹⁾
			$V_{DD} = 4.5 V$ to 5.5 V	0		8 ⁽¹⁾
$t_{r(SCK)}$ $t_{f(SCK)}$	SPI clock rise and fall time	Capacitive load: C = 30 pF	-	25 ⁽²⁾	ns	
$t_{su(NSS)}^{(3)}$	NSS setup time	Slave mode	$4 * t_{MASTER}$	-		
$t_{h(NSS)}^{(3)}$	NSS hold time	Slave mode	70	-		
$t_{w(SCKH)}^{(3)}$ $t_{w(SCKL)}^{(3)}$	SCK high and low time	Master mode	$t_{SCK}/2 - 15$	$t_{SCK}/2 + 15$		
$t_{su(MI)}^{(3)}$ $t_{su(SI)}^{(3)}$	Data input setup time	Master mode	5	-		
		Slave mode	5	-		
$t_{h(MI)}^{(3)}$ $t_{h(SI)}^{(3)}$	Data input hold time	Master mode	7	-		
		Slave mode	10	-		
$t_{a(SO)}^{(3)(4)}$	Data output access time	Slave mode	-	$3 * t_{MASTER}$		
$t_{dis(SO)}^{(3)(5)}$	Data output disable time	Slave mode	25	-		
$t_{v(SO)}^{(3)}$	Data output valid time	Slave mode (after enable edge)	$V_{DD} < 4.5 V$	-		75
		$V_{DD} = 4.5 V$ to 5.5 V	-	53		
$t_{v(MO)}^{(3)}$	Data output valid time	Master mode (after enable edge)	-	30		
$t_{h(SO)}^{(3)}$ $t_{h(MO)}^{(3)}$	Data output hold time	Slave mode (after enable edge)	31	-		
		Master mode (after enable edge)	12	-		

1. $f_{SCK} < f_{MASTER}/2$.

2. The pad has to be configured accordingly (fast mode).

3. Values based on design simulation and/or characterization results, and not tested in production.
4. Min time is for the minimum time to drive the output and the max time is for the maximum time to validate the data.
5. Min time is for the minimum time to invalidate the output and the max time is for the maximum time to put the data in Hi-Z.

Figure 37. SPI timing diagram where slave mode and CPHA = 0

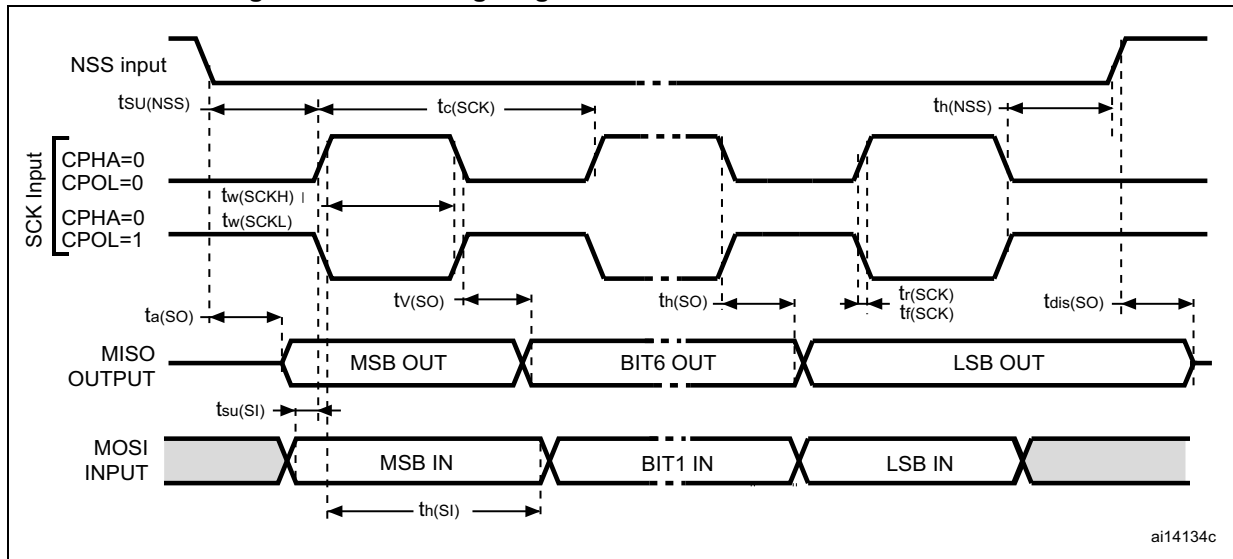

1. Measurement points are at CMOS levels: 0.3 V_{DD} and 0.7 V_{DD} .

Figure 38. SPI timing diagram where slave mode and CPHA = 1

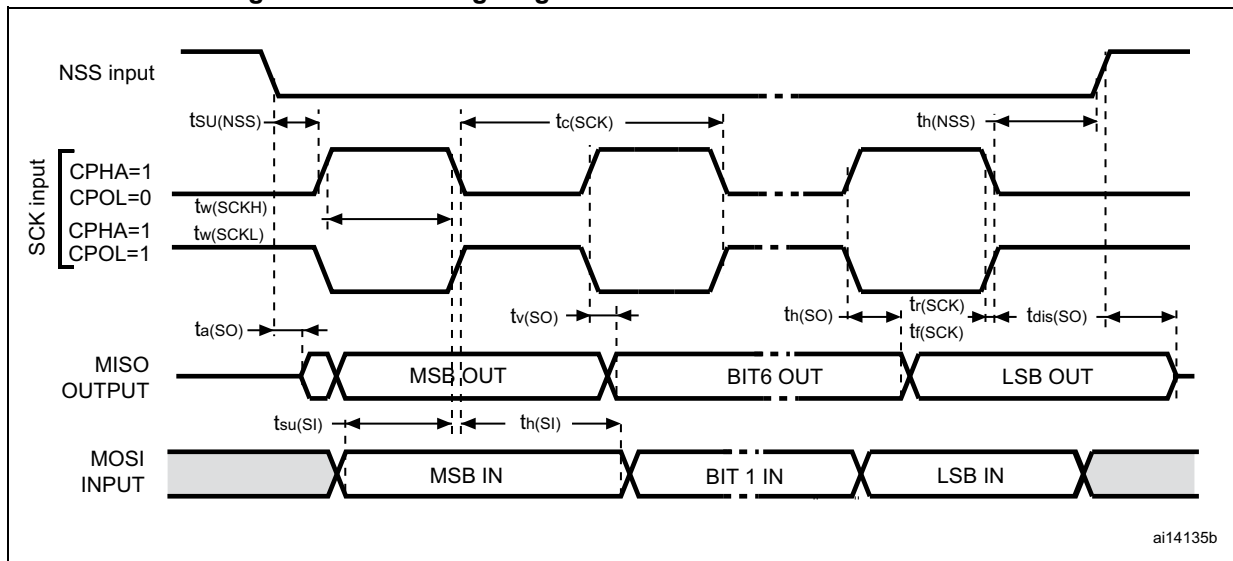

1. Measurement points are at CMOS levels: 0.3 V_{DD} and 0.7 V_{DD} .

Figure 39. SPI timing diagram - master mode



1. Measurement points are at CMOS levels: 0.3 V_{DD} and 0.7 V_{DD} .

10.3.10 I²C interface characteristicsTable 39. I²C characteristics

Symbol	Parameter	Standard mode I ² C		Fast mode I ² C ⁽¹⁾		Unit
		Min ⁽²⁾	Max ⁽²⁾	Min ⁽²⁾	Max ⁽²⁾	
t _{w(SCLL)}	SCL clock low time	4.7	-	1.3	-	μs
t _{w(SCLH)}	SCL clock high time	4.0	-	0.6	-	
t _{su(SDA)}	SDA setup time	250	-	100	-	ns
t _{h(SDA)}	SDA data hold time	0 ⁽³⁾	-	0 ⁽⁴⁾	900 ⁽³⁾	
t _{r(SDA)} t _{r(SCL)}	SDA and SCL rise time (V _{DD} = 3 to 5.5 V)	-	1000	-	300	
t _{f(SDA)} t _{f(SCL)}	SDA and SCL fall time (V _{DD} = 3 to 5.5 V)	-	300	-	300	
t _{h(STA)}	START condition hold time	4.0	-	0.6	-	μs
t _{su(STA)}	Repeated START condition setup time	4.7	-	0.6	-	
t _{su(STO)}	STOP condition setup time	4.0	-	0.6	-	
t _{w(STO:STA)}	STOP to START condition time (bus free)	4.7	-	1.3	-	
C _b	Capacitive load for each bus line	-	400	-	400	pF

1. f_{MASTER} must be at least 8 MHz to achieve max fast I²C speed (400 kHz)
2. Data based on standard I²C protocol requirement, not tested in production
3. The maximum hold time of the start condition has only to be met if the interface does not stretch the low time
4. The device must internally provide a hold time of at least 300 ns for the SDA signal in order to bridge the undefined region of the falling edge of SCL

10.3.11 10-bit ADC characteristics

Subject to general operating conditions for V_{DDA} , f_{MASTER} , and T_A unless otherwise specified.

Table 40. ADC characteristics

Symbol	Parameter	Conditions	Min	Typ	Max	Unit
f_{ADC}	ADC clock frequency	-	111 kHz	-	4 MHz	kHz/MHz
V_{DDA}	Analog supply	-	3	-	5.5	V
V_{REF+}	Positive reference voltage	-	2.75	-	V_{DDA}	
V_{REF-}	Negative reference voltage	-	V_{SSA}	-	0.5	
V_{AIN}	Conversion voltage range ⁽¹⁾	-	V_{SSA}	-	V_{DDA}	
		Devices with external V_{REF+}/V_{REF-} pins	V_{REF-}	-	V_{REF+}	
C_{smp}	Internal sample and hold capacitor	-	-	-	3	pF
$t_S^{(1)}$	Sampling time ($3 \times 1/f_{ADC}$)	$f_{ADC} = 2$ MHz	-	1.5	-	μs
		$f_{ADC} = 4$ MHz	-	0.75	-	
t_{STAB}	Wakeup time from standby	$f_{ADC} = 2$ MHz	-	7	-	
		$f_{ADC} = 4$ MHz	-	3.5	-	
t_{CONV}	Total conversion time including sampling time ($14 \times 1/f_{ADC}$)	$f_{ADC} = 2$ MHz	-	7	-	
		$f_{ADC} = 4$ MHz	-	3.5	-	
R_{switch}	Equivalent switch resistance	-	-	-	30	k Ω

1. During the sample time, the sampling capacitance, C_{smp} (3 pF typ), can be charged/discharged by the external source. The internal resistance of the analog source must allow the capacitance to reach its final voltage level within t_S . After the end of the sample time t_S , changes of the analog input voltage have no effect on the conversion result.

Figure 40. Typical application with ADC



1. Legend: R_{AIN} = external resistance, C_{AIN} = capacitors, C_{smp} = internal sample and hold capacitor.

Table 41. ADC accuracy for $V_{DDA} = 5\text{ V}$

Symbol	Parameter	Conditions	Typ	Max ⁽¹⁾	Unit
$ E_T $	Total unadjusted error ⁽²⁾	$f_{ADC} = 2\text{ MHz}$	1.4	3 ⁽³⁾	LSB
$ E_O $	Offset error ⁽²⁾		0.8	3	
$ E_G $	Gain error ⁽²⁾		0.1	2	
$ E_D $	Differential linearity error ⁽²⁾		0.9	1	
$ E_L $	Integral linearity error ⁽²⁾		0.7	1.5	
$ E_T $	Total unadjusted error ⁽²⁾	$f_{ADC} = 4\text{ MHz}$	1.9 ⁽⁴⁾	4 ⁽⁴⁾	
$ E_O $	Offset error ⁽²⁾		1.3 ⁽⁴⁾	4 ⁽⁴⁾	
$ E_G $	Gain error ⁽²⁾		0.6 ⁽⁴⁾	3 ⁽⁴⁾	
$ E_D $	Differential linearity error ⁽²⁾		1.5 ⁽⁴⁾	2 ⁽⁴⁾	
$ E_L $	Integral linearity error ⁽²⁾		1.2 ⁽⁴⁾	1.5 ⁽⁴⁾	

1. Max value is based on characterization, not tested in production.
2. ADC accuracy vs. injection current: Any positive or negative injection current within the limits specified for $I_{INJ(PIN)}$ and $\Sigma I_{INJ(PIN)}$ in Section 10.3.6 does not affect the ADC accuracy.
3. TUE 2LSB can be reached on specific sales types on the whole temperature range.
4. Target values.

Figure 41. ADC accuracy characteristics



1. Example of an actual transfer curve
2. The ideal transfer curve
3. End point correlation line
 E_T = Total unadjusted error: Maximum deviation between the actual and the ideal transfer curves.
 E_O = Offset error: Deviation between the first actual transition and the first ideal one.
 E_G = Gain error: Deviation between the last ideal transition and the last actual one.
 E_D = Differential linearity error: Maximum deviation between actual steps and the ideal one.
 E_L = Integral linearity error: Maximum deviation between any actual transition and the end point correlation line.

10.3.12 EMC characteristics

Susceptibility tests are performed on a sample basis during product characterization.

Functional EMS (electromagnetic susceptibility)

While executing a simple application (toggling 2 LEDs through I/O ports), the product is stressed by two electromagnetic events until a failure occurs (indicated by the LEDs).

- **ESD:** Electrostatic discharge (positive and negative) is applied on all pins of the device until a functional disturbance occurs. This test conforms with the IEC 1000-4-2 standard.
- **FTB:** A burst of fast transient voltage (positive and negative) is applied to V_{DD} and V_{SS} through a 100 pF capacitor, until a functional disturbance occurs. This test conforms with the IEC 1000-4-4 standard.

A device reset allows normal operations to be resumed. The test results are given in the table below based on the EMS levels and classes defined in application note AN1709.

Designing hardened software to avoid noise problems

EMC characterization and optimization are performed at component level with a typical application environment and simplified MCU software. It should be noted that good EMC performance is highly dependent on the user application and the software in particular.

Therefore it is recommended that the user applies EMC software optimization and prequalification tests in relation with the EMC level requested for his application.

Software recommendations

The software flowchart must include the management of runaway conditions such as:

- Corrupted program counter
- Unexpected reset
- Critical data corruption (control registers...)

Prequalification trials

Most of the common failures (unexpected reset and program counter corruption) can be recovered by applying a low state on the NRST pin or the oscillator pins for 1 second.

To complete these trials, ESD stress can be applied directly on the device, over the range of specification values. When unexpected behavior is detected, the software can be hardened to prevent unrecoverable errors occurring (see application note AN1015).

Table 42. EMS data

Symbol	Parameter	Conditions	Level/class
V_{FESD}	Voltage limits to be applied on any I/O pin to induce a functional disturbance	$V_{DD} = 3.3\text{ V}$, $T_A = 25\text{ }^\circ\text{C}$, $f_{MASTER} = 16\text{ MHz}$ (HSI clock), Conforms to IEC 1000-4-2	3/B
V_{EFTB}	Fast transient voltage burst limits to be applied through 100 pF on V_{DD} and V_{SS} pins to induce a functional disturbance	$V_{DD} = 3.3\text{ V}$, $T_A = 25\text{ }^\circ\text{C}$, $f_{MASTER} = 16\text{ MHz}$ (HSI clock), Conforms to IEC 1000-4-4	4/A

Electromagnetic interference (EMI)

Emission tests conform to the IEC 61967-2 standard for test software, board layout and pin loading.

Table 43. EMI data

Symbol	Parameter	Conditions				Unit
		General conditions	Monitored frequency band	Max f _{CPU} ⁽¹⁾		
				8 MHz	16 MHz	
S _{EMI}	Peak level	V _{DD} = 5 V, T _A = 25 °C, LQFP80 package conforming to IEC 61967-2	0.1 MHz to 30 MHz	15	17	dBμV
			30 MHz to 130 MHz	18	22	
			130 MHz to 1 GHz	-1	3	
	-		2	2.5		
	EMI level					

1. Data based on characterization results, not tested in production.

Absolute maximum ratings (electrical sensitivity)

Based on two different tests (ESD and LU) using specific measurement methods, the product is stressed to determine its performance in terms of electrical sensitivity. For more details, refer to the application note AN1181.

Electrostatic discharge (ESD)

Electrostatic discharges (3 positive then 3 negative pulses separated by 1 second) are applied to the pins of each sample according to each pin combination. The sample size depends on the number of supply pins in the device (3 parts*(n+1) supply pin). This test conforms to the JESD22-A114A/A115A standard. For more details, refer to the application note AN1181.

Table 44. ESD absolute maximum ratings

Symbol	Ratings	Conditions	Class	Maximum value ⁽¹⁾	Unit
V _{ESD(HBM)}	Electrostatic discharge voltage (Human body model)	T _A = 25°C, conforming to JESD22-A114	3A	4000	V
V _{ESD(CDM)}	Electrostatic discharge voltage (Charge device model)	T _A = 25°C, conforming to JESD22-C101	3	500	
V _{ESD(MM)}	Electrostatic discharge voltage (Machine model)	T _A = 25°C, conforming to JESD22-A115	B	200	

1. Data based on characterization results, not tested in production

Static latch-up

Two complementary static tests are required on 10 parts to assess the latch-up performance.

- A supply overvoltage (applied to each power supply pin) and
- A current injection (applied to each input, output and configurable I/O pin) are performed on each sample.

This test conforms to the EIA/JESD 78 IC latch-up standard. For more details, refer to the application note AN1181.

Table 45. Electrical sensitivities

Symbol	Parameter	Conditions	Class ⁽¹⁾
LU	Static latch-up class	$T_A = 25\text{ °C}$	A
		$T_A = 85\text{ °C}$	
		$T_A = 125\text{ °C}$	
		$T_A = 150\text{ °C}$	

1. Class description: A Class is an STMicroelectronics internal specification. All its limits are higher than the JEDEC specifications, that means when a device belongs to class A it exceeds the JEDEC standard. B class strictly covers all the JEDEC criteria (international standard).

11 Package information

In order to meet environmental requirements, ST offers these devices in different grades of ECOPACK® packages, depending on their level of environmental compliance. ECOPACK® specifications, grade definitions and product status are available at: www.st.com. ECOPACK® is an ST trademark.

11.1 VFQFPN32 package information

Figure 42. VFQFPN32 - 32-pin, 5x5 mm, 0.5 mm pitch very thin profile fine pitch quad flat package outline



1. Drawing is not to scale.

Table 46. VFQFPN32 - 32-pin, 5x5 mm, 0.5 mm pitch very thin profile fine pitch quad flat package mechanical data

Symbol	millimeters			inches ⁽¹⁾		
	Min	Typ	Max	Min	Typ	Max
A	0.800	0.900	1.000	0.0315	0.0354	0.0394
A1	0.000	0.020	0.050	0.0000	0.0008	0.0020
A3	-	0.200	-	-	0.0079	-
b	0.180	0.250	0.300	0.0071	0.0098	0.0118
D	4.850	5.000	5.150	0.1909	0.1969	0.2028
D2	3.500	3.600	3.700	0.1378	0.1417	0.1457
E	4.850	5.000	5.150	0.1909	0.1969	0.2028
E2	3.500	3.600	3.700	0.1378	0.1417	0.1457
e	-	0.500	-	-	0.0197	-
L	0.300	0.400	0.500	0.0118	0.0157	0.0197
ddd	-	-	0.050	-	-	0.0020

1. Values in inches are converted from mm and rounded to 4 decimal digits.

Figure 43. VFQFPN32 - 32-pin, 5x5 mm, 0.5 mm pitch very thin profile fine pitch quad flat package recommended footprint

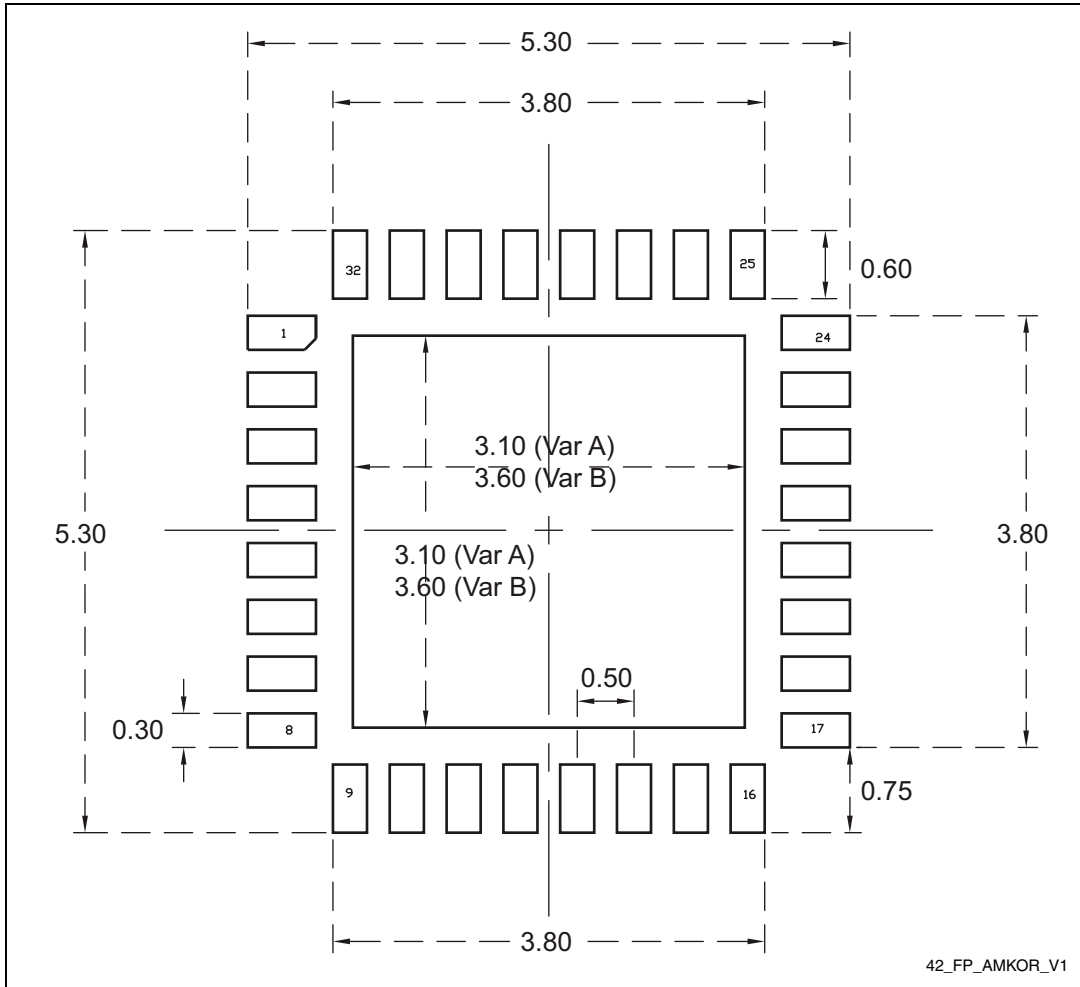

42_FP_AMKOR_V1

1. Dimensions are expressed in millimeters.

Device marking

The following figure gives an example of topside marking orientation versus pin 1 identifier location.

Figure 44. VFQFPN32 marking example (package top view)

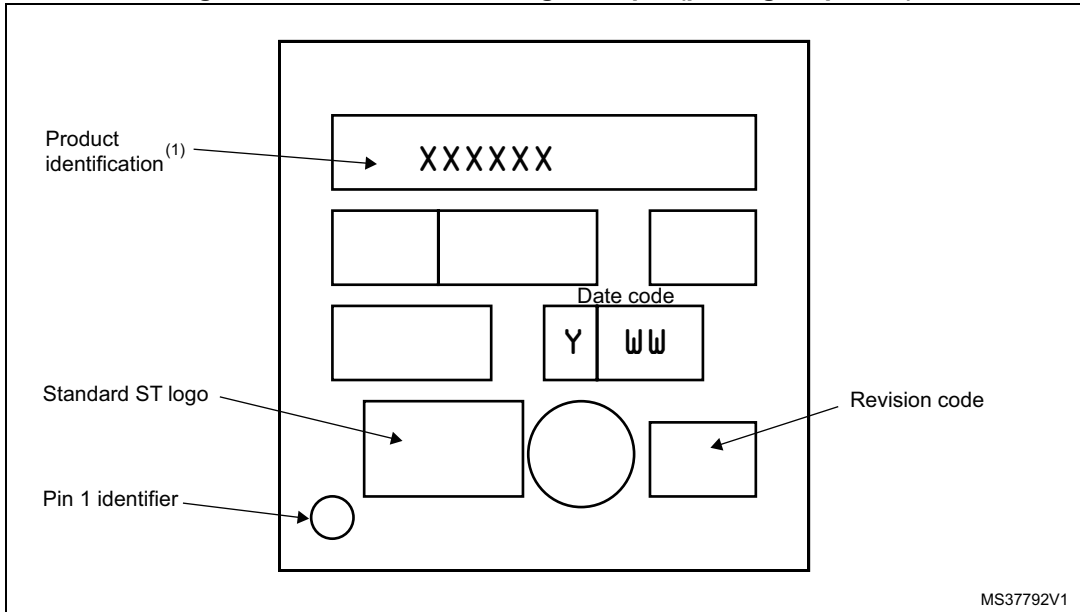

11.2 LQFP48 package information

Figure 45. LQFP48 - 48-pin, 7 x 7 mm low-profile quad flat package outline



1. Drawing is not to scale.

**Table 47. LQFP48 - 48-pin, 7 x 7 mm low-profile quad flat package
mechanical data**

Symbol	millimeters			inches ⁽¹⁾		
	Min	Typ	Max	Min	Typ	Max
A	-	-	1.600	-	-	0.0630
A1	0.050	-	0.150	0.0020	-	0.0059
A2	1.350	1.400	1.450	0.0531	0.0551	0.0571
b	0.170	0.220	0.270	0.0067	0.0087	0.0106
c	0.090	-	0.200	0.0035	-	0.0079
D	8.800	9.000	9.200	0.3465	0.3543	0.3622
D1	6.800	7.000	7.200	0.2677	0.2756	0.2835
D3	-	5.500	-	-	0.2165	-
E	8.800	9.000	9.200	0.3465	0.3543	0.3622
E1	6.800	7.000	7.200	0.2677	0.2756	0.2835
E3	-	5.500	-	-	0.2165	-
e	-	0.500	-	-	0.0197	-
L	0.450	0.600	0.750	0.0177	0.0236	0.0295
L1	-	1.000	-	-	0.0394	-
k	0°	3.5°	7°	0°	3.5°	7°
ccc	-	-	0.080	-	-	0.0031

1. Values in inches are converted from mm and rounded to 4 decimal digits.

Figure 46. LQFP48 - 48-pin, 7 x 7 mm low-profile quad flat package recommended footprint



1. Dimensions are expressed in millimeters.

Device marking

The following figure gives an example of topside marking orientation versus pin 1 identifier location.

Figure 47. LQFP48 marking example (package top view)

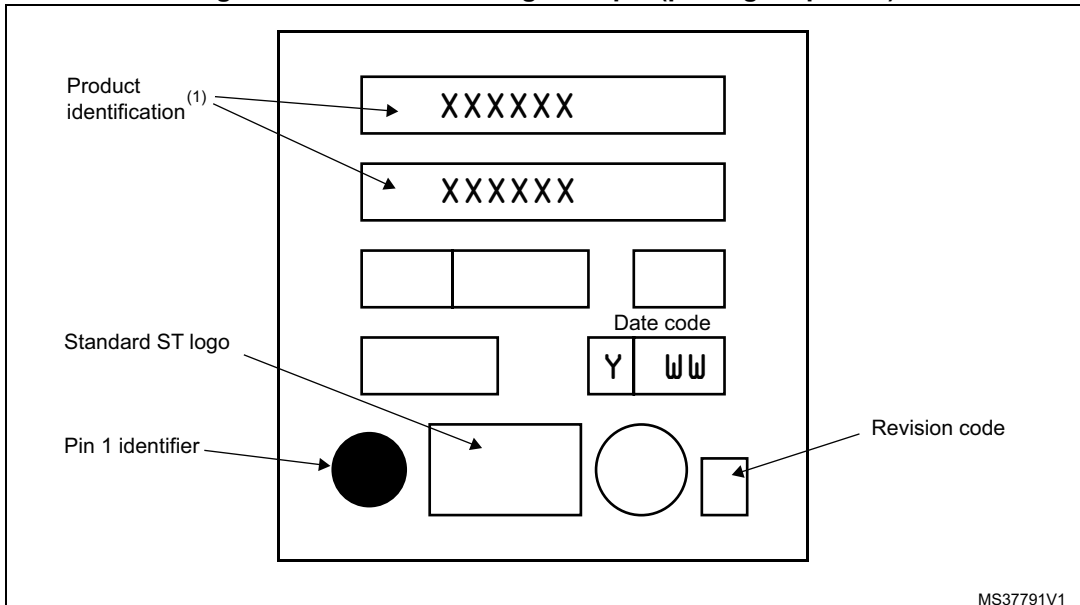

MS37791V1

11.3 LQFP32 package information

Figure 48. LQFP32 - 32-pin, 7 x 7 mm low-profile quad flat package outline



1. Drawing is not to scale.

Table 48. LQFP32 - 32-pin, 7 x 7 mm low-profile quad flat package mechanical data

Symbol	millimeters			inches ⁽¹⁾		
	Min	Typ	Max	Min	Typ	Max
A	-	-	1.600	-	-	0.0630
A1	0.050	-	0.150	0.0020	-	0.0059
A2	1.350	1.400	1.450	0.0531	0.0551	0.0571
b	0.300	0.370	0.450	0.0118	0.0146	0.0177
c	0.090	-	0.200	0.0035	-	0.0079
D	8.800	9.000	9.200	0.3465	0.3543	0.3622
D1	6.800	7.000	7.200	0.2677	0.2756	0.2835
D3	-	5.600	-	-	0.2205	-
E	8.800	9.000	9.200	0.3465	0.3543	0.3622
E1	6.800	7.000	7.200	0.2677	0.2756	0.2835
E3	-	5.600	-	-	0.2205	-
e	-	0.800	-	-	0.0315	-
L	0.450	0.600	0.750	0.0177	0.0236	0.0295
L1	-	1.000	-	-	0.0394	-
k	0°	3.5°	7°	0°	3.5°	7°
ccc	-	-	0.100	-	-	0.0039

1. Values in inches are converted from mm and rounded to 4 decimal digits.

Figure 49. LQFP32 - 32-pin, 7 x 7 mm low-profile quad flat package recommended footprint



1. Dimensions are expressed in millimeters.

Device marking

The following figure gives an example of topside marking orientation versus pin 1 identifier location.

Figure 50. LQFP32 marking example (package top view)



11.4 Thermal characteristics

In case the maximum chip junction temperature (T_{Jmax}) specified in [Table 21: General operating conditions on page 52](#) is exceeded, the functionality of the device cannot be guaranteed.

T_{Jmax} , in degrees Celsius, may be calculated using the following equation:

$$T_{Jmax} = T_{Amax} + (P_{Dmax} \times \Theta_{JA})$$

Where:

- T_{Amax} is the maximum ambient temperature in °C
- Θ_{JA} is the package junction-to-ambient thermal resistance in °C/W
- P_{Dmax} is the sum of P_{INTmax} and $P_{I/Omax}$ ($P_{Dmax} = P_{INTmax} + P_{I/Omax}$)
- P_{INTmax} is the product of I_{DD} and V_{DD} , expressed in Watts. This is the maximum chip internal power.
- $P_{I/Omax}$ represents the maximum power dissipation on output pins

Where:

$$P_{I/Omax} = \Sigma (V_{OL} * I_{OL}) + \Sigma ((V_{DD} - V_{OH}) * I_{OH}),$$

taking into account the actual V_{OL}/I_{OL} and V_{OH}/I_{OH} of the I/Os at low and high level in the application.

Table 49. Thermal characteristics⁽¹⁾

Symbol	Parameter	Value	Unit
Θ_{JA}	Thermal resistance junction-ambient LQFP 48 - 7 x 7 mm	57	°C/W
Θ_{JA}	Thermal resistance junction-ambient LQFP 32 - 7 x 7 mm	59	°C/W
Θ_{JA}	Thermal resistance junction-ambient VFQFPN32	25	°C/W

1. Thermal resistances are based on JEDEC JESD51-2 with 4-layer PCB in a natural convection environment.

11.4.1 Reference document

JESD51-2 integrated circuits thermal test method environment conditions - natural convection (still air). Available from www.jedec.org.

11.4.2 Selecting the product temperature range

When ordering the microcontroller, the temperature range is specified in the order code (see [Section 12: Ordering information](#)).

The following example shows how to calculate the temperature range needed for a given application.

Assuming the following application conditions:

Maximum ambient temperature $T_{Amax} = 82\text{ }^{\circ}\text{C}$ (measured according to JESD51-2),
 $I_{DDmax} = 14\text{ mA}$, $V_{DD} = 5\text{ V}$, maximum 20 I/Os used at the same time in output at low level with $I_{OL} = 8\text{ mA}$, $V_{OL} = 0.4\text{ V}$

$$P_{INTmax} = 14\text{ mA} \times 5\text{ V} = 70\text{ mW}$$

$$P_{IOmax} = 20 \times 8\text{ mA} \times 0.4\text{ V} = 64\text{ mW}$$

This gives: $P_{INTmax} = 70\text{ mW}$ and $P_{IOmax} = 64\text{ mW}$:

$$P_{Dmax} = 70\text{ mW} + 64\text{ mW}$$

Thus: $P_{Dmax} = 134\text{ mW}$.

Using the values obtained in [Table 49: Thermal characteristics](#) T_{Jmax} is calculated as follows:

For LQFP64 $46\text{ }^{\circ}\text{C/W}$

$$T_{Jmax} = 82\text{ }^{\circ}\text{C} + (46\text{ }^{\circ}\text{C/W} \times 134\text{ mW}) = 82\text{ }^{\circ}\text{C} + 6\text{ }^{\circ}\text{C} = 88\text{ }^{\circ}\text{C}$$

This is within the range of the suffix C version parts ($-40 < T_J < 125\text{ }^{\circ}\text{C}$).

Parts must be ordered at least with the temperature range suffix C.

12 Ordering information

Figure 51. STM8AF6246/48/66/68 ordering information scheme^{(1) (2)}



1. For a list of available options (e.g. memory size, package) and orderable part numbers or for further information on any aspect of this device, please go to www.st.com or contact the nearest ST Sales Office.
2. Parts marked as "ES", "E" or accompanied by an Engineering Sample notification letter, are not yet qualified and therefore not yet ready to be used in production and any consequences deriving from such usage will not be at ST charge. In no event, ST will be liable for any customer usage of these engineering samples in production. ST Quality has to be contacted prior to any decision to use these Engineering Samples to run qualification activity.
3. Customer specific FASTROM code or custom device configuration. This field shows 'SSS' if the device contains a super set silicon, usually equipped with bigger memory and more I/Os. This silicon is supposed to be replaced later by the target silicon.

13 STM8 development tools

Development tools for the STM8A microcontrollers include the

- STice emulation system offering tracing and code profiling
- STVD high-level language debugger including assembler and visual development environment - seamless integration of third party C compilers.
- STVP Flash programming software

In addition, the STM8A comes with starter kits, evaluation boards and low-cost in-circuit debugging/programming tools.

13.1 Emulation and in-circuit debugging tools

The STM8 tool line includes the STice emulation system offering a complete range of emulation and in-circuit debugging features on a platform that is designed for versatility and cost-effectiveness. In addition, STM8A application development is supported by a low-cost in-circuit debugger/programmer.

The STice is the fourth generation of full-featured emulators from STMicroelectronics. It offers new advanced debugging capabilities including tracing, profiling and code coverage analysis to help detect execution bottlenecks and dead code.

In addition, STice offers in-circuit debugging and programming of STM8A microcontrollers via the STM8 single wire interface module (SWIM), which allows non-intrusive debugging of an application while it runs on the target microcontroller.

For improved cost effectiveness, STice is based on a modular design that allows users to order exactly what they need to meet their development requirements and to adapt their emulation system to support existing and future ST microcontrollers.

13.1.1 STice key features

- Program and data trace recording up to 128 K records
- Advanced breakpoints with up to 4 levels of conditions
- Data breakpoints
- Real-time read/write of all device resources during emulation
- Occurrence and time profiling and code coverage analysis (new features)
- In-circuit debugging/programming via SWIM protocol
- 8-bit probe analyzer
- 1 input and 2 output triggers
- USB 2.0 high speed interface to host PC
- Power supply follower managing application voltages between 1.62 to 5.5 V
- Modularity that allows users to specify the components they need to meet their development requirements and adapt to future requirements.
- Supported by free software tools that include integrated development environment (IDE), programming software interface and assembler for STM8.

13.2 Software tools

STM8 development tools are supported by a complete, free software package from STMicroelectronics that includes ST visual develop (STVD) IDE and the ST visual programmer (STVP) software interface. STVD provides seamless integration of the Cosmic and Raisonance C compilers for STM8.

13.2.1 STM8 toolset

The STM8 toolset with STVD integrated development environment and STVP programming software is available for free download at www.st.com. This package includes:

ST visual develop

Full-featured integrated development environment from STMicroelectronics, featuring:

- Seamless integration of C and ASM toolsets
- Full-featured debugger
- Project management
- Syntax highlighting editor
- Integrated programming interface
- Support of advanced emulation features for STice such as code profiling and coverage

ST visual programmer (STVP)

Easy-to-use, unlimited graphical interface allowing read, write and verification of the STM8A microcontroller Flash memory. STVP also offers project mode for saving programming configurations and automating programming sequences.

13.2.2 C and assembly toolchains

Control of C and assembly toolchains is seamlessly integrated into the STVD integrated development environment, making it possible to configure and control the building of the application directly from an easy-to-use graphical interface.

Available toolchains include:

C compiler for STM8

All compilers are available in free version with a limited code size depending on the compiler. For more information, refer to www.cosmic-software.com, www.raisonance.com, and www.iar.com.

STM8 assembler linker

Free assembly toolchain included in the STM8 toolset, which allows users to assemble and link the application source code.

13.3 Programming tools

During the development cycle, STice provides in-circuit programming of the STM8A Flash microcontroller on the user application board via the SWIM protocol. Additional tools are used to include a low-cost in-circuit programmer as well as ST socket boards, which provide dedicated programming platforms with sockets for programming the user STM8A.

For production environments, programmers will include a complete range of gang and automated programming solutions from third-party tool developers already supplying programmers for the STM8 family.

14 Revision history

Table 50. Document revision history

Date	Revision	Changes
22-Aug-2008	1	Initial release
10-Aug-2009	2	Document revised as the following: Updated <i>Features</i> ; Updated <i>Table: Device summary</i> ; Updated <i>Section: Product line-up</i> ; Changed <i>Section: Product overview</i> ; Updated <i>Section: Pinouts and pin description</i> ; Changed <i>Section: Register map</i> ; Updated <i>Section: Interrupt table</i> ; Updated <i>Section: Option bytes</i> ; Updated <i>Section: Electrical characteristics</i> ; Updated <i>Section: Package information</i> ; Updated <i>Section: Ordering information</i> ; Added <i>Section: STM8 development tools</i> .
22-Oct-2009	3	Adapted <i>Table: STM8AF61xx/62xx (32 Kbyte) microcontroller pin description</i> . Added <i>Section: LIN header error when automatic resynchronization is enabled</i> .
08-Jul-2010	4	Updated title on cover page. Added VFQFPN32 5x 5 mm package. Added STM8AF62xx devices, and modified cover page header to clarify the part numbers covered by the datasheets. Updated <i>Note 1</i> below <i>Table: Device summary</i> . Updated D temperature range to -40 to 150°C. Content of <i>Section: Product overview</i> reorganized. Renamed <i>Section: Memory and register map</i> , and content merged with Register map section. Renamed BL_EN and NBL_EN, BL and NBL, respectively, in <i>Table: Option bytes</i> . Added <i>Table: Operating lifetime</i> . Added CEXT and P _D (power dissipation) in <i>Table: General operating conditions</i> , and <i>Section: VCAP external capacitor</i> . Suffix D maximum junction temperature (T _J) updated in <i>Table: General operating conditions</i> . Update t _{VDD} in <i>Table: Operating conditions at power-up/power-down</i> . Moved <i>Table: Typical peripheral current consumption VDD = 5.0 V</i> to <i>Section: Current consumption for on-chip peripherals</i> and removed I _{DD(CAN)} . Updated <i>Section: Ordering information</i> for the devices supported by the datasheet. Updated <i>Section: STM8 development tools</i> .

Table 50. Document revision history (continued)

Date	Revision	Changes
31-Jan-2011	5	<p>Modified references to reference manual, and Flash programming manual in the whole document.</p> <p>Added reference to AEC Q100 standard on cover page.</p> <p>Renamed timer types as follows:</p> <ul style="list-style-type: none"> – Auto-reload timer to general purpose timer – Multipurpose timer to advanced control timer – System timer to basic timer <p>Introduced concept of medium density Flash program memory.</p> <p>Updated timer names in <i>Figure: STM8A block diagram</i>.</p> <p>Added TMU brief description in <i>Section: Flash program and data EEPROM</i>, and updated TMU_MAXATT description in <i>Table: Option byte description</i>.</p> <p>Updated clock sources in clock controller features. Changed 16MHZTRIM0 to HSITRIM bit in <i>Section: User trimming</i>.</p> <p>Added <i>Table: Peripheral clock gating bits</i>.</p> <p>Updated <i>Section: Low-power operating modes</i>.</p> <p>Added calibration using TIM3 in <i>Section: Auto-wakeup counter</i>.</p> <p>Added <i>Table: ADC naming</i> and <i>Table: Communication peripheral naming correspondence</i>.</p> <p>Added <i>Note 1</i> related AIN12 pin in <i>Section: Analog-to-digital converter (ADC)</i> and <i>Table: STM8AF61xx/62xx (32 Kbyte) microcontroller pin description</i>.</p> <p>Updated SPI data rate to 10 Mbit/s or $f_{MASTER}/2$ in <i>Section: Serial peripheral interface (SPI)</i>.</p> <p>Added reset state in <i>Table: Legend/abbreviation</i>.</p> <p><i>Table: STM8AF61xx/62xx (32 Kbyte) microcontroller pin description:</i> added <i>Note 7</i> related to PD1/SWIM, modified <i>Note 6</i>, corrected wpu input for PE1 and PE2, and renamed TIMn_CCx and TIMn_NCCx to TIMn_CHx and TIMn_CHxN, respectively.</p> <p>Section: Register map:</p> <p>Replaced tables describing register maps and reset values for non-volatile memory, global configuration, reset status, clock controller, interrupt controller, timers, communication interfaces, and ADC, by <i>Table: General hardware register map</i>.</p> <p>Added <i>Note 1</i> for Px_IDR registers in <i>Table: I/O port hardware register map</i>. Updated register reset values for Px_IDR registers.</p> <p>Added SWIM and debug module register map.</p>

Table 50. Document revision history (continued)

Date	Revision	Changes
31-Jan-2011	5 (continued)	<p>Renamed Fast Active Halt mode to Active-halt mode with regulator on, and Slow Active Halt mode to Active-halt mode with regulator off.</p> <p>Updated <i>Table: Total current consumption in Halt and Active-halt modes</i>. General conditions for VDD apply, TA = -40 to 55 °C, in particular I_{DD(FAH)} and I_{DD(SAH)} renamed I_{DD(AH)}; t_{WU(FAH)} and t_{WU(SAH)} renamed t_{WU(AH)}, and temperature condition added.</p> <p>Removed I_{DD(USART)} from <i>Table: Typical peripheral current consumption VDD = 5.0 V</i>.</p> <p>Updated general conditions in <i>Section: Memory characteristics</i>.</p> <p>Modified T_{WE} maximum value in <i>Table: Flash program memory</i> and <i>Table: Data memory</i>.</p> <p>Update I_{Ikg ana} maximum value for T_A ranging from -40 to 150 °C in <i>Table: I/O static characteristics</i>.</p> <p>Added t_{I_{FP}(NRST)} and renamed V_{F(NRST)} t_{I_{FP}} in <i>Table: NRST pin characteristics</i>. Added recommendations concerning NRST pin level above <i>Figure: Recommended reset pin protection</i>, and updated external capacitor value.</p> <p>Added Raisonance compiler in <i>Section: Software tools</i>.</p> <p>Moved know limitations to separate errata sheet.</p>
18-Jul-2012	6	<p>Updated wildcards of document part numbers.</p> <p><i>Table: Device summary</i>: updated the footnotes to all STM8AF61xx part numbers.</p> <p><i>Section: Introduction</i>: small text change in first paragraph.</p> <p><i>Table: STM8AF62xx product line-up</i>: added "P" version for all order codes; updated RAM.</p> <p><i>Table: STM8AF/H61xx product line-up</i>: added "P" version for all order codes.</p> <p><i>Figure: STM8A block diagram</i>: updated POR, BOR and WDG; updated LINUART input; added legend.</p> <p><i>Section: Flash program and data EEPROM</i>: removed non relevant bullet points and added a sentence about the factory programmer.</p> <p><i>Table: Peripheral clock gating bit assignments in CLK_PCKENR1/2 registers</i>: updated</p> <p><i>ADC features</i>: updated ADC input range.</p> <p><i>Table: Memory model for the devices covered in this datasheet</i>: updated 16 Kbyte and 8 Kbyte information.</p> <p><i>Table: Option bytes</i>: updated factory default setting for NOPT17; added footnote 1.</p> <p><i>Section: Minimum and maximum values</i>: T_A = -40 °C (not 40 °C).</p> <p><i>Table: General operating conditions</i>: updated V_{CAP}.</p> <p><i>Table: Total current consumption in Run, Wait and Slow mode</i> General conditions for VDD apply, TA = -40 to 150 °C: updated conditions for I_{DD(RUN)}.</p> <p><i>Table: I/O static characteristics</i>: added new condition and new max values for rise and fall time; updated the footnote.</p>

Table 50. Document revision history (continued)

Date	Revision	Changes
18-Jul-2012	6 (continued)	<p><i>Section: Reset pin characteristics:</i> updated text below <i>Figure: Typical NRST pull-up current Ipu vs VDD</i>.</p> <p><i>Figure: Recommended reset pin protection:</i> updated unit of capacitor.</p> <p><i>Table: SPI characteristics:</i> updated SCK high and low time conditions and values.</p> <p><i>Figure: SPI timing diagram - master mode:</i> replaced 'SCK input' signals with 'SCK output' signals.</p> <p>Updated <i>Table: VFQFPN 32-lead very thin fine pitch quad flat no-lead package mechanical data</i>, <i>Table: LQFP 48-pin low profile quad flat package mechanical data</i>, and <i>Table: LQFP 32-pin low profile quad flat package mechanical data</i>.</p> <p>Replaced <i>Figure: LQFP 48-pin low profile quad flat package (7 x 7)</i> and <i>Figure: LQFP 32-pin low profile quad flat package (7 x 7)</i>.</p> <p>Added <i>Figure: LQFP 48-pin recommended footprint</i> and <i>Figure: LQFP 32-pin recommended footprint</i>.</p> <p><i>Figure: Ordering information scheme(1):</i> added footnote 1, added "xxx" and footnote 2, updated example and device family; added FASTROM.</p> <p><i>Section: C and assembly toolchains:</i> added www.iar.com</p>
04-Apr-2014	7	<p>Updated:</p> <ul style="list-style-type: none"> - <i>Table: Device summary</i>, - <i>Table: STM8AF62xx product line-up</i>, - <i>Table: STM8AF/H61xx product line-up</i>. - SPI description in <i>Features</i>. - The typical and maximum values for t_{TEMP} reset release delay in <i>Table: Operating conditions at power-up/power-down</i>. - The symbol for NRST Input not filtered pulse duration in <i>Table: NRST pin characteristics</i> - The address and comment of Reset interrupt in <i>Table: STM8A interrupt table</i>. <p>Added the three footnotes to <i>Figure VFQFPN 32-lead very thin fine pitch quad flat no-lead package (5 x 5)</i>.</p>
24-Jun-2014	8	<p>Updated <i>Table: HSI oscillator characteristics</i>.</p> <p>Added HSI accuracy and removed temperature range B in <i>Figure: Ordering information scheme(1)</i>.</p>
12-Nov-2014	9	<p>Updates in <i>Table: HSI oscillator characteristics</i> (HSI oscillator accuracy (factory calibrated) values) and <i>Figure: Ordering information scheme(1)</i> (changed the value for I).</p>

Table 50. Document revision history (continued)

Date	Revision	Changes
09-Jun-2015	10	<p>Updated:</p> <ul style="list-style-type: none"> – the product naming in the document headers and captions, – LIN version in <i>Features</i> and <i>Section 5.9.3: Universal asynchronous receiver/transmitter with LIN support (LINUART)</i>. <p>Added:</p> <ul style="list-style-type: none"> – the third table footnote to <i>Table 22: Operating conditions at power-up/power-down</i>, – <i>Figure 44: VFQFPN32 marking example (package top view)</i>, – <i>Figure 47: LQFP48 marking example (package top view)</i>, – <i>Figure 50: LQFP32 marking example (package top view)</i>, – the note about the parts marked “E” and “ES” below <i>Figure 51: STM8AF6246/48/66/68 ordering information scheme(1) (2)</i>, – the standard for EMI characteristics in <i>Table 43: EMI data</i>. <p>Removed the references to STM8AF61xx and STM8AH61xx obsolete products.</p> <p>Moved <i>Section 11.4: Thermal characteristics</i> to <i>Section 11: Package information</i>.</p>
14-Jun-2016	11	Update <i>Table 46: VFQFPN32 - 32-pin, 5x5 mm, 0.5 mm pitch very thin profile fine pitch quad flat package mechanical data</i>

IMPORTANT NOTICE – PLEASE READ CAREFULLY

STMicroelectronics NV and its subsidiaries ("ST") reserve the right to make changes, corrections, enhancements, modifications, and improvements to ST products and/or to this document at any time without notice. Purchasers should obtain the latest relevant information on ST products before placing orders. ST products are sold pursuant to ST's terms and conditions of sale in place at the time of order acknowledgement.

Purchasers are solely responsible for the choice, selection, and use of ST products and ST assumes no liability for application assistance or the design of Purchasers' products.

No license, express or implied, to any intellectual property right is granted by ST herein.

Resale of ST products with provisions different from the information set forth herein shall void any warranty granted by ST for such product.

ST and the ST logo are trademarks of ST. All other product or service names are the property of their respective owners.

Information in this document supersedes and replaces information previously supplied in any prior versions of this document.

© 2016 STMicroelectronics – All rights reserved

