

This programming manual provides information for application and system-level software developers. It gives a full description of the STM32F10xxx/20xxx/21xxx/L1xxx Cortex™-M3 processor programming model, instruction set and core peripherals.

The STM32F10xxx/20xxx/21xxx/L1xxx Cortex™-M3 processor is a high performance 32-bit processor designed for the microcontroller market. It offers significant benefits to developers, including:

- Outstanding processing performance combined with fast interrupt handling
- Enhanced system debug with extensive breakpoint and trace capabilities
- Efficient processor core, system and memories
- Ultra-low power consumption with integrated sleep modes
- Platform security

Contents

1	About this document	9
1.1	Typographical conventions	9
1.2	List of abbreviations for registers	9
1.3	About the STM32 Cortex-M3 processor and core peripherals	9
1.3.1	System level interface	10
1.3.2	Integrated configurable debug	10
1.3.3	Cortex-M3 processor features and benefits summary	11
1.3.4	Cortex-M3 core peripherals	12
2	The Cortex-M3 processor	13
2.1	Programmers model	13
2.1.1	Processor mode and privilege levels for software execution	13
2.1.2	Stacks	13
2.1.3	Core registers	14
2.1.4	Exceptions and interrupts	22
2.1.5	Data types	22
2.1.6	The Cortex microcontroller software interface standard (CMSIS)	23
2.2	Memory model	24
2.2.1	Memory regions, types and attributes	25
2.2.2	Memory system ordering of memory accesses	26
2.2.3	Behavior of memory accesses	26
2.2.4	Software ordering of memory accesses	27
2.2.5	Bit-banding	28
2.2.6	Memory endianness	30
2.2.7	Synchronization primitives	31
2.2.8	Programming hints for the synchronization primitives	32
2.3	Exception model	33
2.3.1	Exception states	33
2.3.2	Exception types	33
2.3.3	Exception handlers	35
2.3.4	Vector table	36
2.3.5	Exception priorities	36
2.3.6	Interrupt priority grouping	37
2.3.7	Exception entry and return	38

2.4	Fault handling	40
2.4.1	Fault types	40
2.4.2	Fault escalation and hard faults	41
2.4.3	Fault status registers and fault address registers	42
2.4.4	Lockup	42
2.5	Power management	42
2.5.1	Entering sleep mode	43
2.5.2	Wakeup from sleep mode	43
2.5.3	The external event input	44
2.5.4	Power management programming hints	44
3	The Cortex-M3 instruction set	45
3.1	Instruction set summary	45
3.2	Intrinsic functions	50
3.3	About the instruction descriptions	51
3.3.1	Operands	51
3.3.2	Restrictions when using PC or SP	52
3.3.3	Flexible second operand	52
3.3.4	Shift operations	53
3.3.5	Address alignment	56
3.3.6	PC-relative expressions	56
3.3.7	Conditional execution	57
3.3.8	Instruction width selection	59
3.4	Memory access instructions	60
3.4.1	ADR	60
3.4.2	LDR and STR, immediate offset	61
3.4.3	LDR and STR, register offset	63
3.4.4	LDR and STR, unprivileged	64
3.4.5	LDR, PC-relative	65
3.4.6	LDM and STM	67
3.4.7	PUSH and POP	68
3.4.8	LDREX and STREX	70
3.4.9	CLREX	71
3.5	General data processing instructions	72
3.5.1	ADD, ADC, SUB, SBC, and RSB	73
3.5.2	AND, ORR, EOR, BIC, and ORN	75

- 3.5.3 ASR, LSL, LSR, ROR, and RRX 76
- 3.5.4 CLZ 77
- 3.5.5 CMP and CMN 78
- 3.5.6 MOV and MVN 79
- 3.5.7 MOVT 80
- 3.5.8 REV, REV16, REVSH, and RBIT 81
- 3.5.9 TST and TEQ 82
- 3.6 Multiply and divide instructions 83
 - 3.6.1 MUL, MLA, and MLS 83
 - 3.6.2 UMULL, UMLAL, SMULL, and SMLAL 85
 - 3.6.3 SDIV and UDIV 86
- 3.7 Saturating instructions 87
 - 3.7.1 SSAT and USAT 87
- 3.8 Bitfield instructions 88
 - 3.8.1 BFC and BFI 89
 - 3.8.2 SBFX and UBFX 89
 - 3.8.3 SXT and UXT 90
 - 3.8.4 Branch and control instructions 91
 - 3.8.5 B, BL, BX, and BLX 92
 - 3.8.6 CBZ and CBNZ 93
 - 3.8.7 IT 94
 - 3.8.8 TBB and TBH 96
- 3.9 Miscellaneous instructions 97
 - 3.9.1 BKPT 98
 - 3.9.2 CPS 98
 - 3.9.3 DMB 99
 - 3.9.4 DSB 100
 - 3.9.5 ISB 100
 - 3.9.6 MRS 100
 - 3.9.7 MSR 101
 - 3.9.8 NOP 102
 - 3.9.9 SEV 102
 - 3.9.10 SVC 103
 - 3.9.11 WFE 103
 - 3.9.12 WFI 104

4 Core peripherals 105



4.1	About the STM32 core peripherals	105
4.2	Memory protection unit (MPU)	105
4.2.1	MPU access permission attributes	106
4.2.2	MPU mismatch	108
4.2.3	Updating an MPU region	108
4.2.4	MPU design hints and tips	110
4.2.5	MPU type register (MPU_TYPER)	111
4.2.6	MPU control register (MPU_CR)	112
4.2.7	MPU region number register (MPU_RNR)	113
4.2.8	MPU region base address register (MPU_RBAR)	114
4.2.9	MPU region attribute and size register (MPU_RASR)	116
4.3	Nested vectored interrupt controller (NVIC)	118
4.3.1	The CMSIS mapping of the Cortex-M3 NVIC registers	119
4.3.2	Interrupt set-enable registers (NVIC_ISERx)	120
4.3.3	Interrupt clear-enable registers (NVIC_ICERx)	121
4.3.4	Interrupt set-pending registers (NVIC_ISPRx)	122
4.3.5	Interrupt clear-pending registers (NVIC_ICPRx)	123
4.3.6	Interrupt active bit registers (NVIC_IABRx)	124
4.3.7	Interrupt priority registers (NVIC_IPRx)	125
4.3.8	Software trigger interrupt register (NVIC_STIR)	126
4.3.9	Level-sensitive and pulse interrupts	126
4.3.10	NVIC design hints and tips	127
4.3.11	NVIC register map	128
4.4	System control block (SCB)	129
4.4.1	Auxiliary control register (SCB_ACTLR)	129
4.4.2	CPUID base register (SCB_CPUID)	130
4.4.3	Interrupt control and state register (SCB_ICSR)	131
4.4.4	Vector table offset register (SCB_VTOR)	133
4.4.5	Application interrupt and reset control register (SCB_AIRCR)	134
4.4.6	System control register (SCB_SCR)	136
4.4.7	Configuration and control register (SCB_CCR)	137
4.4.8	System handler priority registers (SHPRx)	138
4.4.9	System handler control and state register (SCB_SHCSR)	140
4.4.10	Configurable fault status register (SCB_CFSR)	142
4.4.11	Hard fault status register (SCB_HFSR)	145
4.4.12	Memory management fault address register (SCB_MMFAR)	147
4.4.13	Bus fault address register (SCB_BFAR)	147

4.4.14	System control block design hints and tips	148
4.4.15	SCB register map	148
4.5	SysTick timer (STK)	150
4.5.1	SysTick control and status register (STK_CTRL)	151
4.5.2	SysTick reload value register (STK_LOAD)	152
4.5.3	SysTick current value register (STK_VAL)	153
4.5.4	SysTick calibration value register (STK_CALIB)	153
4.5.5	SysTick design hints and tips	154
4.5.6	SysTick register map	154
5	Revision history	155

List of tables

Table 1.	Summary of processor mode, execution privilege level, and stack use options	14
Table 2.	Core register set summary	14
Table 3.	PSR register combinations	16
Table 4.	APSR bit definitions	17
Table 5.	IPSR bit definitions	18
Table 6.	EPSR bit definitions	19
Table 7.	PRIMASK register bit definitions	20
Table 8.	FAULTMASK register bit definitions	20
Table 9.	BASEPRI register bit assignments	21
Table 10.	CONTROL register bit definitions	21
Table 11.	Ordering of memory accesses	26
Table 12.	Memory access behavior	26
Table 13.	SRAM memory bit-banding regions	28
Table 14.	Peripheral memory bit-banding regions	28
Table 15.	C compiler intrinsic functions for exclusive access instructions	32
Table 16.	Properties of the different exception types	34
Table 17.	Exception return behavior	40
Table 18.	Faults	40
Table 19.	Fault status and fault address registers	42
Table 20.	Cortex-M3 instructions	45
Table 21.	CMSIS intrinsic functions to generate some Cortex-M3 instructions	50
Table 22.	CMSIS intrinsic functions to access the special registers	51
Table 23.	Condition code suffixes	58
Table 24.	Memory access instructions	60
Table 25.	Immediate, pre-indexed and post-indexed offset ranges	62
Table 26.	<i>label</i> -PC offset ranges	66
Table 27.	Data processing instructions	72
Table 28.	Multiply and divide instructions	83
Table 29.	Packing and unpacking instructions	88
Table 30.	Branch and control instructions	91
Table 31.	Branch ranges	92
Table 32.	Miscellaneous instructions	97
Table 33.	STM32 core peripheral register regions	105
Table 34.	Memory attributes summary	106
Table 35.	TEX, C, B, and S encoding	107
Table 36.	Cache policy for memory attribute encoding	107
Table 37.	AP encoding	108
Table 38.	Memory region attributes for STM32	111
Table 39.	Example SIZE field values	117
Table 40.	MPU register map and reset values	117
Table 41.	Mapping of interrupts to the interrupt variables	119
Table 42.	IPR bit assignments	125
Table 43.	CMSIS functions for NVIC control	127
Table 44.	NVIC register map and reset values	128
Table 45.	Priority grouping	135
Table 46.	System fault handler priority fields	138
Table 47.	SCB register map and reset value for STM32F2 and STM32L	148
Table 48.	SCB register map and reset values	149
Table 49.	SysTick register map and reset values	154
Table 50.	Document revision history	155

List of figures

Figure 1.	STM32 Cortex-M3 implementation	10
Figure 2.	Processor core registers	14
Figure 3.	APSR, IPSR and EPSR bit assignments	16
Figure 4.	PSR bit assignments	16
Figure 5.	PRIMASK bit assignments	20
Figure 6.	FAULTMASK bit assignments	20
Figure 7.	BASEPRI bit assignments	21
Figure 8.	CONTROL bit assignments	21
Figure 9.	Memory map	24
Figure 10.	Bit-band mapping	29
Figure 11.	Little-endian example	30
Figure 12.	Vector table	36
Figure 13.	ASR#3	54
Figure 14.	LSR#3	54
Figure 15.	LSL#3	55
Figure 16.	ROR #3	55
Figure 17.	RRX #3	56
Figure 18.	Subregion example	110
Figure 19.	NVIC_IPRx register mapping	125
Figure 20.	CFSR subregisters	142

1 About this document

This document provides the information required for application and system-level software development. It does not provide information on debug components, features, or operation.

This material is for microcontroller software and hardware engineers, including those who have no experience of ARM products.

1.1 Typographical conventions

The typographical conventions used in this document are:

<i>italic</i>	Highlights important notes, introduces special terminology, denotes internal cross-references, and citations.
< and >	Enclose replaceable terms for assembler syntax where they appear in code or code fragments. For example: LDRSB<cond> <Rt>, [<Rn>, #<offset>]

1.2 List of abbreviations for registers

The following abbreviations are used in register descriptions:

read/write (rw)	Software can read and write to these bits.
read-only (r)	Software can only read these bits.
write-only (w)	Software can only write to this bit. Reading the bit returns the reset value.
read/clear (rc_w1)	Software can read as well as clear this bit by writing 1. Writing '0' has no effect on the bit value.
read/clear (rc_w0)	Software can read as well as clear this bit by writing 0. Writing '1' has no effect on the bit value.
toggle (t)	Software can only toggle this bit by writing '1'. Writing '0' has no effect.
Reserved (Res.)	Reserved bit, must be kept at reset value.

1.3 About the STM32 Cortex-M3 processor and core peripherals

The Cortex-M3 processor is built on a high-performance processor core, with a 3-stage pipeline Harvard architecture, making it ideal for demanding embedded applications. The processor delivers exceptional power efficiency through an efficient instruction set and extensively optimized design, providing high-end processing hardware including single-cycle 32x32 multiplication and dedicated hardware division.

Figure 1. STM32 Cortex-M3 implementation

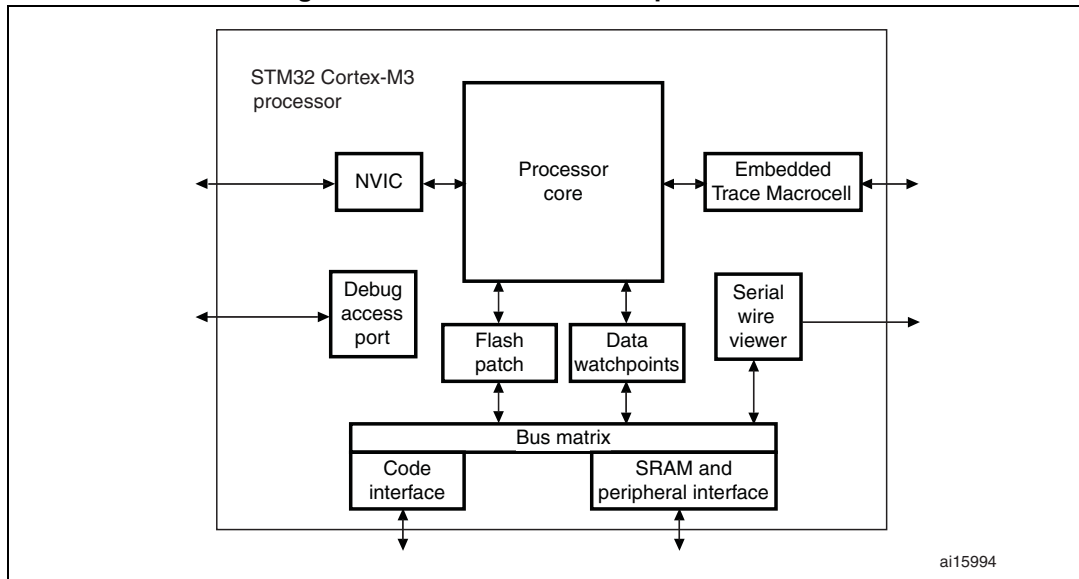

To facilitate the design of cost-sensitive devices, the Cortex-M3 processor implements tightly-coupled system components that reduce processor area while significantly improving interrupt handling and system debug capabilities. The Cortex-M3 processor implements a version of the Thumb[®] instruction set, ensuring high code density and reduced program memory requirements. The Cortex-M3 instruction set provides the exceptional performance expected of a modern 32-bit architecture, with the high code density of 8-bit and 16-bit microcontrollers.

The Cortex-M3 processor closely integrates a configurable nested interrupt controller (NVIC), to deliver industry-leading interrupt performance. The NVIC includes a non-maskable interrupt (NMI), and provides up to 256 interrupt priority levels. The tight integration of the processor core and NVIC provides fast execution of interrupt service routines (ISRs), dramatically reducing the interrupt latency. This is achieved through the hardware stacking of registers, and the ability to suspend load-multiple and store-multiple operations. Interrupt handlers do not require any assembler stubs, removing any code overhead from the ISRs. Tail-chaining optimization also significantly reduces the overhead when switching from one ISR to another.

To optimize low-power designs, the NVIC integrates with the sleep modes, that include a deep sleep function that enables the STM32 to enter STOP or STDBY mode.

1.3.1 System level interface

The Cortex-M3 processor provides multiple interfaces using AMBA[®] technology to provide high speed, low latency memory accesses. It supports unaligned data accesses and implements atomic bit manipulation that enables faster peripheral controls, system spinlocks and thread-safe Boolean data handling.

1.3.2 Integrated configurable debug

The Cortex-M3 processor implements a complete hardware debug solution. This provides high system visibility of the processor and memory through either a traditional JTAG port or a 2-pin *Serial Wire Debug* (SWD) port that is ideal for small package devices.

For system trace the processor integrates an *Instrumentation Trace Macrocell* (ITM) alongside data watchpoints and a profiling unit. To enable simple and cost-effective profiling of the system events these generate, a *Serial Wire Viewer* (SWV) can export a stream of software-generated messages, data trace, and profiling information through a single pin.

The optional *Embedded Trace Macrocell*[™] (ETM) delivers unrivalled instruction trace capture in an area far smaller than traditional trace units, enabling many low cost MCUs to implement full instruction trace for the first time.

1.3.3 Cortex-M3 processor features and benefits summary

- Tight integration of system peripherals reduces area and development costs
- Thumb instruction set combines high code density with 32-bit performance
- Code-patch ability for ROM system updates
- Power control optimization of system components
- Integrated sleep modes for low power consumption
- Fast code execution permits slower processor clock or increases sleep mode time
- Hardware division and fast multiplier
- Deterministic, high-performance interrupt handling for time-critical applications
- Extensive debug and trace capabilities:
 - Serial Wire Debug and Serial Wire Trace reduce the number of pins required for debugging and tracing.

1.3.4 Cortex-M3 core peripherals

These are:

Nested vectored interrupt controller

The *nested vectored interrupt controller* (NVIC) is an embedded interrupt controller that supports low latency interrupt processing.

System control block

The *system control block* (SCB) is the programmers model interface to the processor. It provides system implementation information and system control, including configuration, control, and reporting of system exceptions.

System timer

The system timer, SysTick, is a 24-bit count-down timer. Use this as a Real Time Operating System (RTOS) tick timer or as a simple counter.

2 The Cortex-M3 processor

2.1 Programmers model

This section describes the Cortex-M3 programmers model. In addition to the individual core register descriptions, it contains information about the processor modes and privilege levels for software execution and stacks.

2.1.1 Processor mode and privilege levels for software execution

The processor *modes* are:

Thread mode	Used to execute application software. The processor enters Thread mode when it comes out of reset.
Handler mode	Used to handle exceptions. The processor returns to Thread mode when it has finished exception processing.

The *privilege levels* for software execution are:

Unprivileged	<p>The software:</p> <ul style="list-style-type: none">• Has limited access to the MSR and MRS instructions, and cannot use the CPS instruction• Cannot access the system timer, NVIC, or system control block• Might have restricted access to memory or peripherals. <p><i>Unprivileged software</i> executes at the unprivileged level.</p>
Privileged	<p>The software can use all the instructions and has access to all resources.</p> <p><i>Privileged software</i> executes at the privileged level.</p>

In Thread mode, the CONTROL register controls whether software execution is privileged or unprivileged, see [CONTROL register on page 21](#). In Handler mode, software execution is always privileged.

Only privileged software can write to the CONTROL register to change the privilege level for software execution in Thread mode. Unprivileged software can use the SVC instruction to make a *supervisor call* to transfer control to privileged software.

2.1.2 Stacks

The processor uses a full descending stack. This means the stack pointer indicates the last stacked item on the stack memory. When the processor pushes a new item onto the stack, it decrements the stack pointer and then writes the item to the new memory location. The processor implements two stacks, the *main stack* and the *process stack*, with independent copies of the stack pointer, see [Stack pointer on page 15](#).

In Thread mode, the CONTROL register controls whether the processor uses the main stack or the process stack, see [CONTROL register on page 21](#). In Handler mode, the processor always uses the main stack. The options for processor operations are:

Table 1. Summary of processor mode, execution privilege level, and stack use options

Processor mode	Used to execute	Privilege level for software execution	Stack used
Thread	Applications	Privileged or unprivileged ⁽¹⁾	Main stack or process stack ⁽¹⁾
Handler	Exception handlers	Always privileged	Main stack

1. See [CONTROL register on page 21](#).

2.1.3 Core registers

Figure 2. Processor core registers

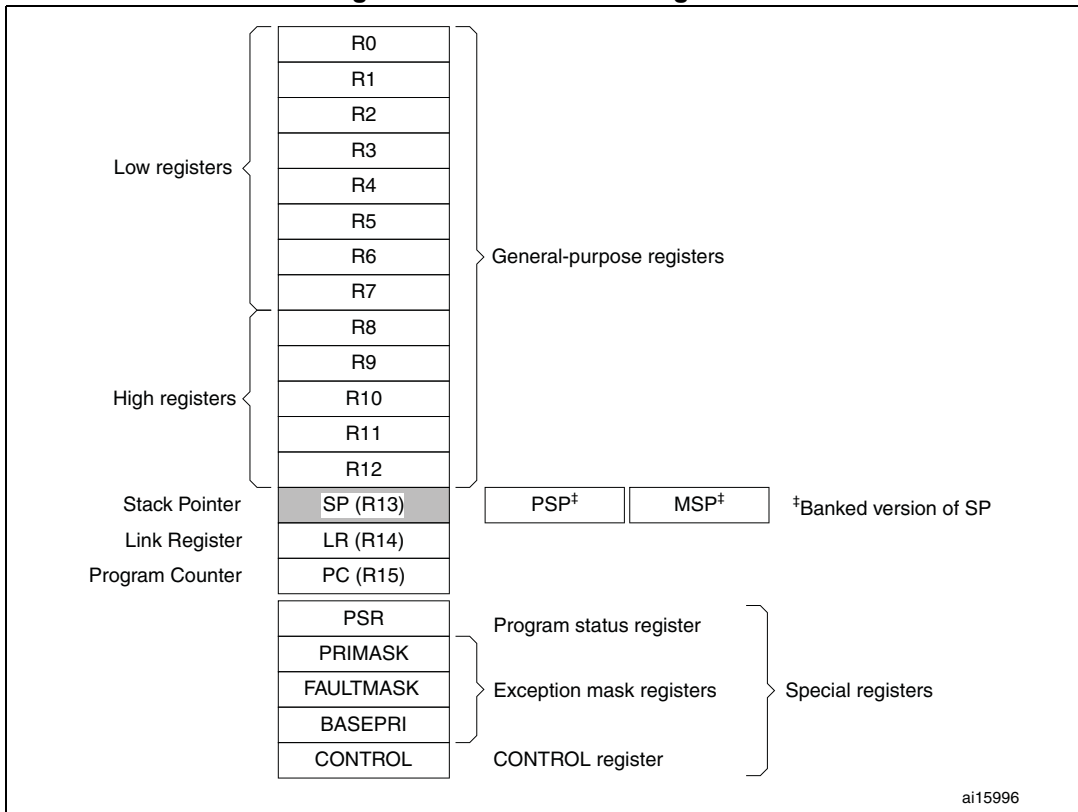

Table 2. Core register set summary

Name	Type ⁽¹⁾	Required privilege ⁽²⁾	Reset value	Description
R0-R12	read-write	Either	Unknown	General-purpose registers on page 15
MSP	read-write	Privileged	See description	Stack pointer on page 15
PSP	read-write	Either	Unknown	Stack pointer on page 15

Table 2. Core register set summary (continued)

Name	Type ⁽¹⁾	Required privilege ⁽²⁾	Reset value	Description
LR	read-write	Either	0xFFFFFFFF	Link register on page 15
PC	read-write	Either	See description	Program counter on page 15
PSR	read-write	Privileged	0x01000000	Program status register on page 16
ASPR	read-write	Either	0x00000000	Application program status register on page 17
IPSR	read-only	Privileged	0x00000000	Interrupt program status register on page 18
EPSR	read-only	Privileged	0x01000000	Execution program status register on page 19
PRIMASK	read-write	Privileged	0x00000000	Priority mask register on page 20
FAULTMASK	read-write	Privileged	0x00000000	Fault mask register on page 20
BASEPRI	read-write	Privileged	0x00000000	Base priority mask register on page 21
CONTROL	read-write	Privileged	0x00000000	CONTROL register on page 21

1. Describes access type during program execution in thread mode and Handler mode. Debug access can differ.

2. An entry of Either means privileged and unprivileged software can access the register.

General-purpose registers

R0-R12 are 32-bit general-purpose registers for data operations.

Stack pointer

The *Stack Pointer* (SP) is register R13. In Thread mode, bit[1] of the CONTROL register indicates the stack pointer to use:

- 0 = *Main Stack Pointer* (MSP). This is the reset value.
- 1 = *Process Stack Pointer* (PSP).

On reset, the processor loads the MSP with the value from address 0x00000000.

Link register

The *Link Register* (LR) is register R14. It stores the return information for subroutines, function calls, and exceptions. On reset, the processor loads the LR value 0xFFFFFFFF.

Program counter

The *Program Counter* (PC) is register R15. It contains the current program address. Bit[0] is always 0 because instruction fetches must be halfword aligned. On reset, the processor loads the PC with the value of the reset vector, which is at address 0x00000004.

Program status register

The *Program Status Register* (PSR) combines:

- *Application Program Status Register* (APSR)
- *Interrupt Program Status Register* (IPSR)
- *Execution Program Status Register* (EPSR)

These registers are mutually exclusive bitfields in the 32-bit PSR. The bit assignments are as shown in [Figure 3](#) and [Figure 4](#).

Figure 3. APSR, IPSR and EPSR bit assignments

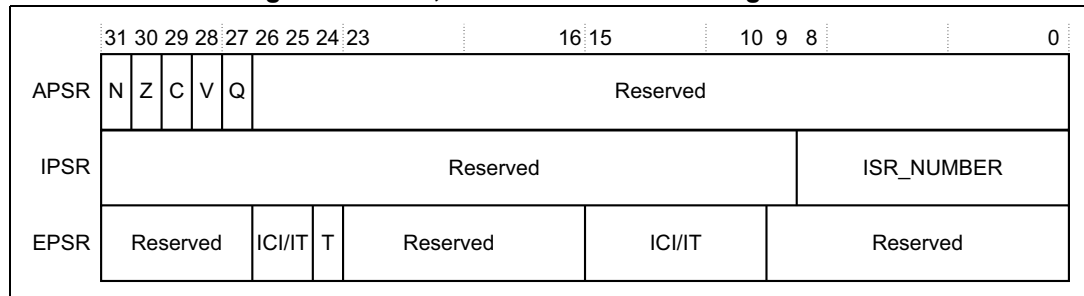
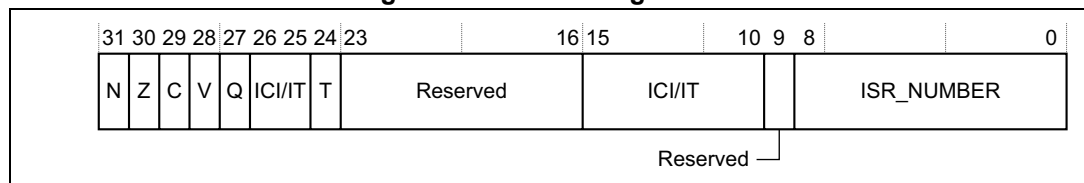

Figure 4. PSR bit assignments



Access these registers individually or as a combination of any two or all three registers, using the register name as an argument to the MSR or MRS instructions. For example:

- Read all of the registers using PSR with the MRS instruction
- Write to the APSR using APSR with the MSR instruction.

The PSR combinations and attributes are:

Table 3. PSR register combinations

Register	Type	Combination
PSR	read-write ^{(1), (2)}	APSR, EPSR, and IPSR
IEPSR	read-only	EPSR and IPSR
IAPSR	read-write ⁽¹⁾	APSR and IPSR
EAPSR	read-write ⁽²⁾	APSR and EPSR

1. The processor ignores writes to the IPSR bits.
2. Reads of the EPSR bits return zero, and the processor ignores writes to the these bits

See the instruction descriptions [MRS on page 100](#) and [MSR on page 101](#) for more information about how to access the program status registers.

Application program status register

The APSR contains the current state of the condition flags from previous instruction executions. See the register summary in [Table 2 on page 14](#) for its attributes. The bit assignments are:

Table 4. APSR bit definitions

Bits	Description
Bit 31	N: Negative or less than flag: 0: Operation result was positive, zero, greater than, or equal 1: Operation result was negative or less than.
Bit 30	Z: Zero flag: 0: Operation result was not zero 1: Operation result was zero.
Bit 29	C: Carry or borrow flag: 0: Add operation did not result in a carry bit or subtract operation resulted in a borrow bit 1: Add operation resulted in a carry bit or subtract operation did not result in a borrow bit.
Bit 28	V: Overflow flag: 0: Operation did not result in an overflow 1: Operation resulted in an overflow.
Bit 27	Q: Sticky saturation flag: 0: Indicates that saturation has not occurred since reset or since the bit was last cleared to zero 1: Indicates when an SSAT or USAT instruction results in saturation. This bit is cleared to zero by software using an MRS instruction.
Bits 26:0	Reserved.

Interrupt program status register

The IPSR contains the exception type number of the current *Interrupt Service Routine* (ISR). See the register summary in [Table 2 on page 14](#) for its attributes. The bit assignments are:

Table 5. IPSR bit definitions

Bits	Description
Bits 31:9	Reserved
Bits 8:0	<p>ISR_NUMBER: This is the number of the current exception:</p> <ul style="list-style-type: none"> 0: Thread mode 1: Reserved 2: NMI 3: Hard fault 4: Memory management fault 5: Bus fault 6: Usage fault 7: Reserved 10: Reserved 11: SVCall 12: Reserved for Debug 13: Reserved 14: PendSV 15: SysTick 16: IRQ0⁽¹⁾ 83: IRQ67⁽¹⁾ <p>see Exception types on page 33 for more information.</p>

1. See STM32 product reference manual/datasheet for more information on interrupt mapping

Execution program status register

The EPSR contains the Thumb state bit, and the execution state bits for either the:

- *If-Then* (IT) instruction
- *Interruptible-Continuable Instruction* (ICI) field for an interrupted load multiple or store multiple instruction.

See the register summary in [Table 2 on page 14](#) for the EPSR attributes. The bit assignments are:

Table 6. EPSR bit definitions

Bits	Description
Bits 31:27	Reserved.
Bits 26:25, 15:10	ICI: Interruptible-continuable instruction bits See Interruptible-continuable instructions on page 19 .
Bits 26:25, 15:10	IT: Indicates the execution state bits of the IT instruction, see IT on page 94 .
Bit 24	Always set to 1.
Bits 23:16	Reserved.
Bits 9:0]	Reserved.

Attempts to read the EPSR directly through application software using the MSR instruction always return zero. Attempts to write the EPSR using the MSR instruction in application software are ignored. Fault handlers can examine EPSR value in the stacked PSR to indicate the operation that is at fault. See [Section 2.3.7: Exception entry and return on page 38](#)

Interruptible-continuable instructions

When an interrupt occurs during the execution of an LDM or STM instruction, the processor:

- Stops the load multiple or store multiple instruction operation temporarily
- Stores the next register operand in the multiple operation to EPSR bits[15:12].

After servicing the interrupt, the processor:

- Returns to the register pointed to by bits[15:12]
- Resumes execution of the multiple load or store instruction.

When the EPSR holds ICI execution state, bits[26:25,11:10] are zero.

If-Then block

The If-Then block contains up to four instructions following a 16-bit IT instruction. Each instruction in the block is conditional. The conditions for the instructions are either all the same, or some can be the inverse of others. See [IT on page 94](#) for more information.

Exception mask registers

The exception mask registers disable the handling of exceptions by the processor. Disable exceptions where they might impact on timing critical tasks.

To access the exception mask registers use the MSR and MRS instructions, or the CPS instruction to change the value of PRIMASK or FAULTMASK. See [MRS on page 100](#), [MSR on page 101](#), and [CPS on page 98](#) for more information.

Priority mask register

The PRIMASK register prevents activation of all exceptions with configurable priority. See the register summary in [Table 2 on page 14](#) for its attributes. [Figure 5](#) shows the bit assignments.

Figure 5. PRIMASK bit assignments

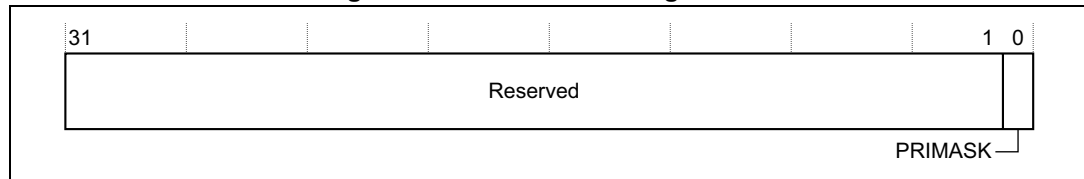

Table 7. PRIMASK register bit definitions

Bits	Description
Bits 31:1	Reserved
Bit 0	PRIMASK: 0: No effect 1: Prevents the activation of all exceptions with configurable priority.

Fault mask register

The FAULTMASK register prevents activation of all exceptions except for *Non-Maskable Interrupt* (NMI). See the register summary in [Table 2 on page 14](#) for its attributes. [Figure 6](#) shows the bit assignments.

Figure 6. FAULTMASK bit assignments

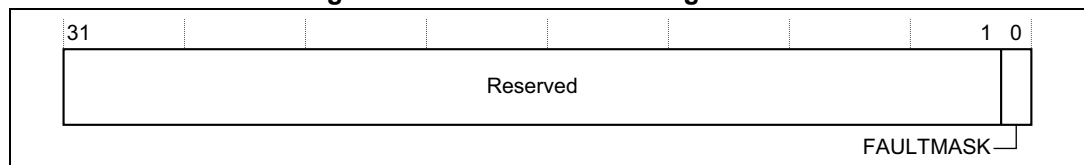

Table 8. FAULTMASK register bit definitions

Bits	Function
Bits 31:1	Reserved
Bit 0	FAULTMASK: 0: No effect 1: Prevents the activation of all exceptions except for NMI.

The processor clears the FAULTMASK bit to 0 on exit from any exception handler except the NMI handler.

Base priority mask register

The BASEPRI register defines the minimum priority for exception processing. When BASEPRI is set to a nonzero value, it prevents the activation of all exceptions with same or lower priority level as the BASEPRI value. See the register summary in [Table 2 on page 14](#) for its attributes. [Figure 7](#) shows the bit assignments.

Figure 7. BASEPRI bit assignments

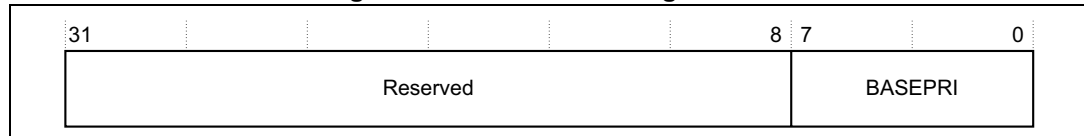

Table 9. BASEPRI register bit assignments

Bits	Function
Bits 31:8	Reserved
Bits 7:4	BASEPRI[7:4] Priority mask bits ⁽¹⁾ 0x00: no effect Nonzero: defines the base priority for exception processing. The processor does not process any exception with a priority value greater than or equal to BASEPRI.
Bits 3:0	Reserved

1. This field is similar to the priority fields in the interrupt priority registers. See [Interrupt priority registers \(NVIC_IPRx\) on page 125](#) for more information. Remember that higher priority field values correspond to lower exception priorities.

CONTROL register

The CONTROL register controls the stack used and the privilege level for software execution when the processor is in Thread mode. See the register summary in [Table 2 on page 14](#) for its attributes. [Figure 8](#) shows the bit assignments.

Figure 8. CONTROL bit assignments

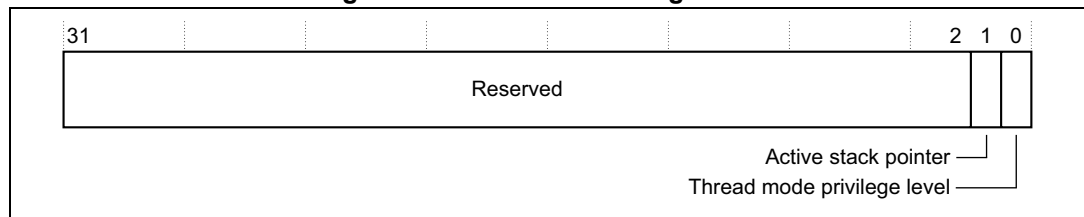

Table 10. CONTROL register bit definitions

Bits	Function
Bits 31:2	Reserved

Table 10. CONTROL register bit definitions (continued)

Bits	Function
Bit 1	ASPSEL: Active stack pointer selection Selects the current stack: 0: MSP is the current stack pointer 1: PSP is the current stack pointer. In Handler mode this bit reads as zero and ignores writes.
Bit 0	TPL: Thread mode privilege level Defines the Thread mode privilege level. 0: Privileged 1: Unprivileged.

Handler mode always uses the MSP, so the processor ignores explicit writes to the active stack pointer bit of the CONTROL register when in Handler mode. The exception entry and return mechanisms update the CONTROL register.

In an OS environment, it is recommended that threads running in Thread mode use the process stack and the kernel and exception handlers use the main stack.

By default, Thread mode uses the MSP. To switch the stack pointer used in Thread mode to the PSP, use the MSR instruction to set the Active stack pointer bit to 1, see [MSR on page 101](#).

When changing the stack pointer, software must use an ISB instruction immediately after the MSR instruction. This ensures that instructions after the ISB execute using the new stack pointer. See [ISB on page 100](#)

2.1.4 Exceptions and interrupts

The Cortex-M3 processor supports interrupts and system exceptions. The processor and the *Nested Vectored Interrupt Controller* (NVIC) prioritize and handle all exceptions. An exception changes the normal flow of software control. The processor uses handler mode to handle all exceptions except for reset. See [Exception entry on page 38](#) and [Exception return on page 39](#) for more information.

The NVIC registers control interrupt handling. See [Memory protection unit \(MPU\) on page 105](#) for more information.

2.1.5 Data types

The processor:

- Supports the following data types:
 - 32-bit words
 - 16-bit halfwords
 - 8-bit bytes
- supports 64-bit data transfer instructions.
- manages all memory accesses (data memory, instruction memory and *Private Peripheral Bus* (PPB)) as little-endian. See [Memory regions, types and attributes on page 25](#) for more information.

2.1.6 The Cortex microcontroller software interface standard (CMSIS)

For a Cortex-M3 microcontroller system, the *Cortex Microcontroller Software Interface Standard* (CMSIS) defines:

- A common way to:
 - Access peripheral registers
 - Define exception vectors
- The names of:
 - The registers of the core peripherals
 - The core exception vectors
- A device-independent interface for RTOS kernels, including a debug channel

The CMSIS includes address definitions and data structures for the core peripherals in the Cortex-M3 processor. It also includes optional interfaces for middleware components comprising a TCP/IP stack and a Flash file system.

CMSIS simplifies software development by enabling the reuse of template code and the combination of CMSIS-compliant software components from various middleware vendors. Software vendors can expand the CMSIS to include their peripheral definitions and access functions for those peripherals.

This document includes the register names defined by the CMSIS, and gives short descriptions of the CMSIS functions that address the processor core and the core peripherals.

This document uses the register short names defined by the CMSIS. In a few cases these differ from the architectural short names that might be used in other documents.

The following sections give more information about the CMSIS:

- [Section 2.5.4: Power management programming hints on page 44](#)
- [Intrinsic functions on page 50](#)
- [The CMSIS mapping of the Cortex-M3 NVIC registers on page 119](#)
- [NVIC programming hints on page 127](#)

2.2 Memory model

This section describes the processor memory map, the behavior of memory accesses, and the bit-banding features. The processor has a fixed memory map that provides up to 4 GB of addressable memory.

Figure 9. Memory map

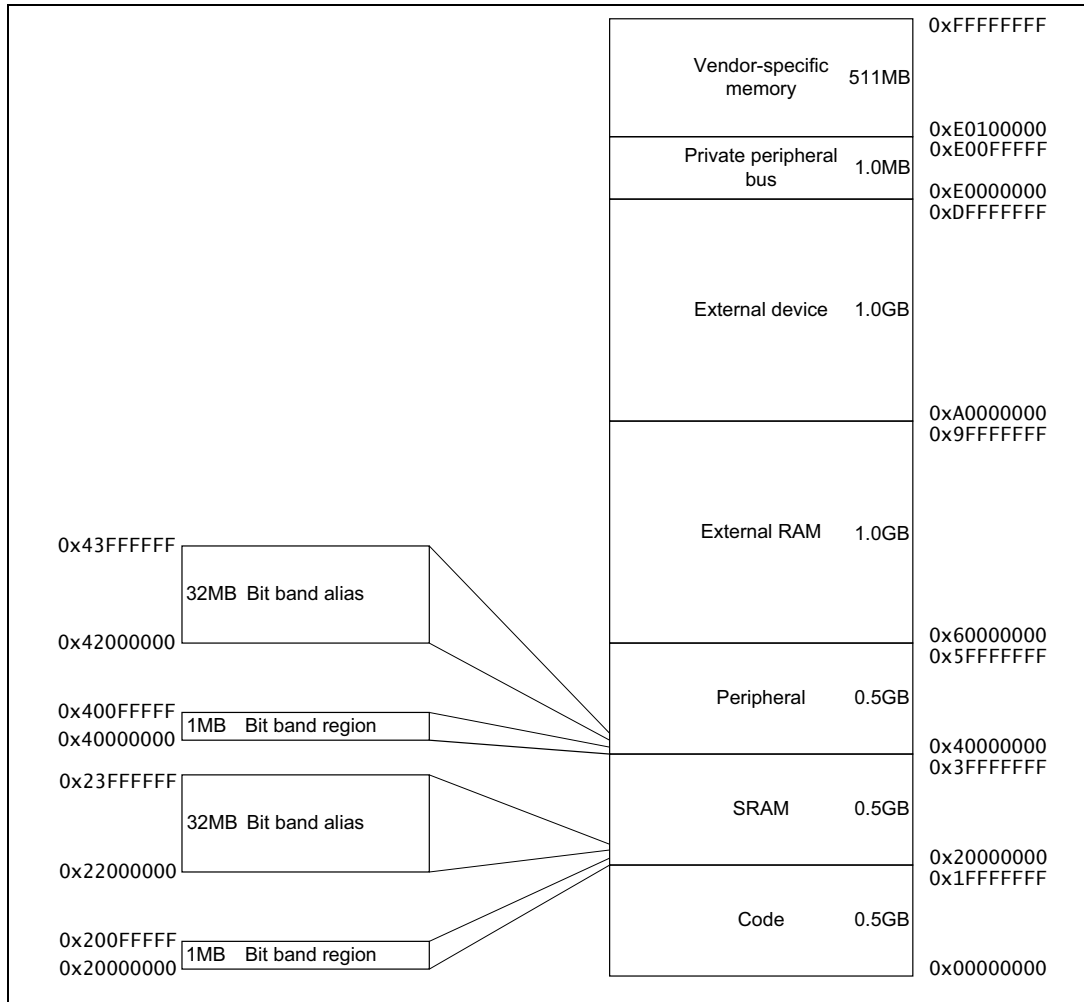

The regions for SRAM and peripherals include bit-band regions. Bit-banding provides atomic operations to bit data, see [Section 2.2.5: Bit-banding on page 28](#).

The processor reserves regions of the *Private peripheral bus* (PPB) address range for core peripheral registers, see [Section 4.1: About the STM32 core peripherals on page 105](#).

2.2.1 Memory regions, types and attributes

The memory map splits the memory map into regions. Each region has a defined memory type, and some regions have additional memory attributes. The memory type and attributes determine the behavior of accesses to the region.

The memory types are:

Normal	The processor can re-order transactions for efficiency, or perform speculative reads.
Device	The processor preserves transaction order relative to other transactions to Device or Strongly-ordered memory.
Strongly-ordered	The processor preserves transaction order relative to all other transactions.

The different ordering requirements for Device and Strongly-ordered memory mean that the memory system can buffer a write to Device memory, but must not buffer a write to Strongly-ordered memory.

The additional memory attributes include:

<i>Execute Never (XN)</i>	Means the processor prevents instruction accesses. Any attempt to fetch an instruction from an XN region causes a memory management fault exception.
---------------------------	--

2.2.2 Memory system ordering of memory accesses

For most memory accesses caused by explicit memory access instructions, the memory system does not guarantee that the order in which the accesses complete matches the program order of the instructions, providing this does not affect the behavior of the instruction sequence. Normally, if correct program execution depends on two memory accesses completing in program order, software must insert a memory barrier instruction between the memory access instructions, see [Section 2.2.4: Software ordering of memory accesses on page 27](#).

However, the memory system does guarantee some ordering of accesses to Device and Strongly-ordered memory. For two memory access instructions A1 and A2, if A1 occurs before A2 in program order, the ordering of the memory accesses caused by two instructions is:

Table 11. Ordering of memory accesses⁽¹⁾

A1	A2			
	Normal access	Device access		Strongly ordered access
		Non-shareable	Shareable	
Normal access	-	-	-	-
Device access, non-shareable	-	<	-	<
Device access, shareable	-	-	<	<
Strongly ordered access	-	<	<	<

1. - means that the memory system does not guarantee the ordering of the accesses.
 < means that accesses are observed in program order, that is, A1 is always observed before A2.

2.2.3 Behavior of memory accesses

The behavior of accesses to each region in the memory map is:

Table 12. Memory access behavior

Address range	Memory region	Memory type	XN	Description
0x00000000- 0x1FFFFFFF	Code	Normal ⁽¹⁾	-	Executable region for program code. You can also put data here.
0x20000000- 0x3FFFFFFF	SRAM	Normal ⁽¹⁾	-	Executable region for data. You can also put code here. This region includes bit band and bit band alias areas, see Table 13 on page 28 .
0x40000000- 0x5FFFFFFF	Peripheral	Device ⁽¹⁾	XN ⁽¹⁾	This region includes bit band and bit band alias areas, see Table 14 on page 28 .
0x60000000- 0x9FFFFFFF	External RAM	Normal ⁽¹⁾	-	Executable region for data.

Table 12. Memory access behavior (continued)

Address range	Memory region	Memory type	XN	Description
0xA0000000- 0xDFFFFFFF	External device	Device ⁽¹⁾	XN ⁽¹⁾	External Device memory
0xE0000000- 0xE0FFFFFF	Private Peripheral Bus	Strongly-ordered ⁽¹⁾	XN ⁽¹⁾	This region includes the NVIC, System timer, and system control block.
0xE0100000- 0xFFFFFFFF	Memory mapped peripherals	Device ⁽¹⁾	XN ⁽¹⁾	This region includes all the STM32 standard peripherals.

1. See [Memory regions, types and attributes on page 25](#) for more information.

The Code, SRAM, and external RAM regions can hold programs. However, it is recommended that programs always use the Code region. This is because the processor has separate buses that enable instruction fetches and data accesses to occur simultaneously.

2.2.4 Software ordering of memory accesses

The order of instructions in the program flow does not always guarantee the order of the corresponding memory transactions. This is because:

- The processor can reorder some memory accesses to improve efficiency, providing this does not affect the behavior of the instruction sequence.
- The processor has multiple bus interfaces
- Memory or devices in the memory map have different wait states
- Some memory accesses are buffered or speculative.

[Section 2.2.2: Memory system ordering of memory accesses on page 26](#) describes the cases where the memory system guarantees the order of memory accesses. Otherwise, if the order of memory accesses is critical, software must include memory barrier instructions to force that ordering. The processor provides the following memory barrier instructions:

DMB	The <i>Data Memory Barrier</i> (DMB) instruction ensures that outstanding memory transactions complete before subsequent memory transactions. See DMB on page 99 .
DSB	The <i>Data Synchronization Barrier</i> (DSB) instruction ensures that outstanding memory transactions complete before subsequent instructions execute. See DSB on page 100 .
ISB	The <i>Instruction Synchronization Barrier</i> (ISB) ensures that the effect of all completed memory transactions is recognizable by subsequent instructions. See ISB on page 100 .

Use memory barrier instructions in, for example:

- **Vector table.** If the program changes an entry in the vector table, and then enables the corresponding exception, use a DMB instruction between the operations. This ensures

that if the exception is taken immediately after being enabled the processor uses the new exception vector.

- **Self-modifying code.** If a program contains self-modifying code, use an ISB instruction immediately after the code modification in the program. This ensures subsequent instruction execution uses the updated program.
- **Memory map switching.** If the system contains a memory map switching mechanism, use a DSB instruction after switching the memory map in the program. This ensures subsequent instruction execution uses the updated memory map.
- **Dynamic exception priority change.** When an exception priority has to change when the exception is pending or active, use DSB instructions after the change. This ensures the change takes effect on completion of the DSB instruction.
- **Using a semaphore in multi-master system.** If the system contains more than one bus master, for example, if another processor is present in the system, each processor must use a DMB instruction after any semaphore instructions, to ensure other bus masters see the memory transactions in the order in which they were executed.

Memory accesses to Strongly-ordered memory, such as the system control block, do not require the use of DMB instructions.

2.2.5 Bit-banding

A bit-band region maps each word in a *bit-band alias* region to a single bit in the *bit-band region*. The bit-band regions occupy the lowest 1 MB of the SRAM and peripheral memory regions.

The memory map has two 32 MB alias regions that map to two 1 MB bit-band regions:

- Accesses to the 32 MB SRAM alias region map to the 1 MB SRAM bit-band region, as shown in [Table 13](#)
- Accesses to the 32 MB peripheral alias region map to the 1 MB peripheral bit-band region, as shown in [Table 14](#).

Table 13. SRAM memory bit-banding regions

Address range	Memory region	Instruction and data accesses
0x20000000-0x200FFFFFF	SRAM bit-band region	Direct accesses to this memory range behave as SRAM memory accesses, but this region is also bit addressable through bit-band alias.
0x22000000-0x23FFFFFF	SRAM bit-band alias	Data accesses to this region are remapped to bit band region. A write operation is performed as read-modify-write. Instruction accesses are not remapped.

Table 14. Peripheral memory bit-banding regions

Address range	Memory region	Instruction and data accesses
0x40000000-0x400FFFFFF	Peripheral bit-band region	Direct accesses to this memory range behave as peripheral memory accesses, but this region is also bit addressable through bit-band alias.
0x42000000-0x43FFFFFF	Peripheral bit-band alias	Data accesses to this region are remapped to bit-band region. A write operation is performed as read-modify-write. Instruction accesses are not permitted.

A word access to the SRAM or peripheral bit-band alias regions map to a single bit in the SRAM or peripheral bit-band region.

The following formula shows how the alias region maps onto the bit-band region:

$$\text{bit_word_offset} = (\text{byte_offset} \times 32) + (\text{bit_number} \times 4)$$

$$\text{bit_word_addr} = \text{bit_band_base} + \text{bit_word_offset}$$

Where:

- Bit_word_offset is the position of the target bit in the bit-band memory region.
- Bit_word_addr is the address of the word in the alias memory region that maps to the targeted bit.
- Bit_band_base is the starting address of the alias region.
- Byte_offset is the number of the byte in the bit-band region that contains the targeted bit.
- Bit_number is the bit position, 0-7, of the targeted bit.

Figure 10 on page 29 shows examples of bit-band mapping between the SRAM bit-band alias region and the SRAM bit-band region:

- The alias word at 0x23FFFFE0 maps to bit[0] of the bit-band byte at 0x200FFFFF: $0x23FFFFE0 = 0x22000000 + (0xFFFF \times 32) + (0 \times 4)$.
- The alias word at 0x23FFFFFC maps to bit[7] of the bit-band byte at 0x200FFFFF: $0x23FFFFFC = 0x22000000 + (0xFFFF \times 32) + (7 \times 4)$.
- The alias word at 0x22000000 maps to bit[0] of the bit-band byte at 0x20000000: $0x22000000 = 0x22000000 + (0 \times 32) + (0 \times 4)$.
- The alias word at 0x2200001C maps to bit[7] of the bit-band byte at 0x20000000: $0x2200001C = 0x22000000 + (0 \times 32) + (7 \times 4)$.

Figure 10. Bit-band mapping

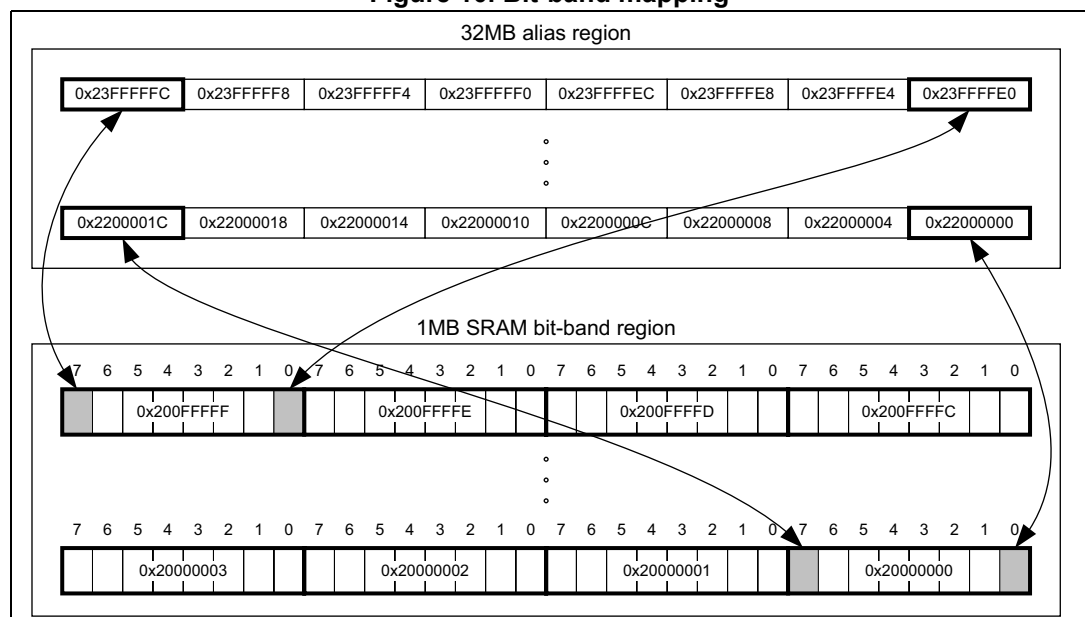

Directly accessing an alias region

Writing to a word in the alias region updates a single bit in the bit-band region.

Bit[0] of the value written to a word in the alias region determines the value written to the targeted bit in the bit-band region. Writing a value with bit[0] set to 1 writes a 1 to the bit-band bit, and writing a value with bit[0] set to 0 writes a 0 to the bit-band bit.

Bits[31:1] of the alias word have no effect on the bit-band bit. Writing 0x01 has the same effect as writing 0xFF. Writing 0x00 has the same effect as writing 0x0E.

Reading a word in the alias region:

- 0x00000000 indicates that the targeted bit in the bit-band region is set to zero
- 0x00000001 indicates that the targeted bit in the bit-band region is set to 1

Directly accessing a bit-band region

[Behavior of memory accesses on page 26](#) describes the behavior of direct byte, halfword, or word accesses to the bit-band regions.

2.2.6 Memory endianness

The processor views memory as a linear collection of bytes numbered in ascending order from zero. For example, bytes 0-3 hold the first stored word, and bytes 4-7 hold the second stored word.

Little-endian format

In little-endian format, the processor stores the least significant byte of a word at the lowest-numbered byte, and the most significant byte at the highest-numbered byte. See [Figure 11](#) for an example.

Figure 11. Little-endian example

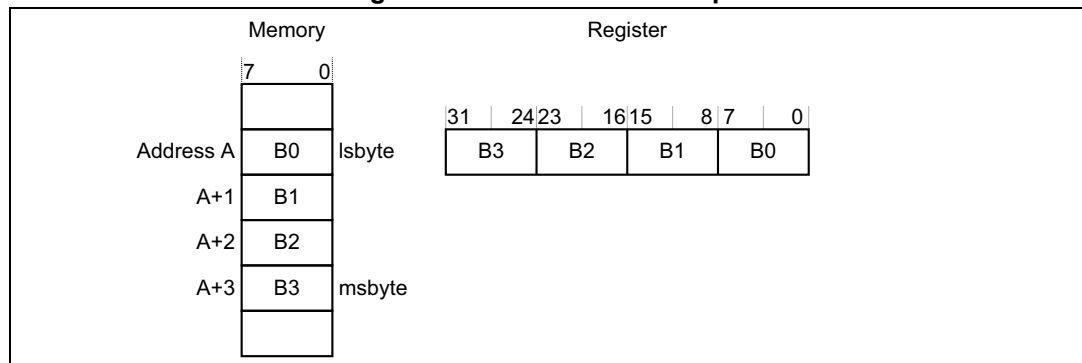

2.2.7 Synchronization primitives

The Cortex-M3 instruction set includes pairs of *synchronization primitives*. These provide a non-blocking mechanism that a thread or process can use to obtain exclusive access to a memory location. Software can use them to perform a guaranteed read-modify-write memory update sequence, or for a semaphore mechanism.

A pair of synchronization primitives comprises:

A Load-Exclusive instruction	Used to read the value of a memory location, requesting exclusive access to that location.
A Store-Exclusive instruction	Used to attempt to write to the same memory location, returning a status bit to a register. If this bit is: <ul style="list-style-type: none"> 0: it indicates that the thread or process gained exclusive access to the memory, and the write succeeds 1: it indicates that the thread or process did not gain exclusive access to the memory, and no write is performed

The pairs of Load-Exclusive and Store-Exclusive instructions are:

- The word instructions LDREX and STREX
- The halfword instructions LDREXH and STREXH
- The byte instructions LDREXB and STREXB.

Software must use a Load-Exclusive instruction with the corresponding Store-Exclusive instruction.

To perform a guaranteed read-modify-write of a memory location, software must:

1. Use a Load-Exclusive instruction to read the value of the location.
2. Update the value, as required.
3. Use a Store-Exclusive instruction to attempt to write the new value back to the memory location, and tests the returned status bit. If this bit is:
 - 0: The read-modify-write completed successfully,
 - 1: No write was performed. This indicates that the value returned at step 1 might be out of date. The software must retry the read-modify-write sequence,

Software can use the synchronization primitives to implement a semaphores as follows:

1. Use a Load-Exclusive instruction to read from the semaphore address to check whether the semaphore is free.
2. If the semaphore is free, use a Store-Exclusive to write the claim value to the semaphore address.
3. If the returned status bit from step 2 indicates that the Store-Exclusive succeeded then the software has claimed the semaphore. However, if the Store-Exclusive failed, another process might have claimed the semaphore after the software performed step 1.

The Cortex-M3 includes an exclusive access monitor, that tags the fact that the processor has executed a Load-Exclusive instruction.

The processor removes its exclusive access tag if:

- It executes a CLREX instruction
- It executes a Store-Exclusive instruction, regardless of whether the write succeeds.
- An exception occurs. This means the processor can resolve semaphore conflicts between different threads.

For more information about the synchronization primitive instructions, see [LDREX and STREX on page 70](#) and [CLREX on page 71](#).

2.2.8 Programming hints for the synchronization primitives

ANSI C cannot directly generate the exclusive access instructions. Some C compilers provide intrinsic functions for generation of these instructions:

Table 15. C compiler intrinsic functions for exclusive access instructions

Instruction	Intrinsic function
LDREX, LDREXH, or LDREXB	<code>unsigned int __ldrex(volatile void *ptr)</code>
STREX, STREXH, or STREXB	<code>int __strex(unsigned int val, volatile void *ptr)</code>
CLREX	<code>void __clrex(void)</code>

The actual exclusive access instruction generated depends on the data type of the pointer passed to the intrinsic function. For example, the following C code generates the require LDREXB operation:

```
__ldrex((volatile char *) 0xFF);
```

2.3 Exception model

This section describes the exception model.

2.3.1 Exception states

Each exception is in one of the following states:

Inactive	The exception is not active and not pending.
Pending	The exception is waiting to be serviced by the processor. An interrupt request from a peripheral or from software can change the state of the corresponding interrupt to pending.
Active	An exception that is being serviced by the processor but has not completed. <i>Note: An exception handler can interrupt the execution of another exception handler. In this case both exceptions are in the active state.</i>
Active and pending	The exception is being serviced by the processor and there is a pending exception from the same source.

2.3.2 Exception types

The exception types are:

Reset	Reset is invoked on power up or a warm reset. The exception model treats reset as a special form of exception. When reset is asserted, the operation of the processor stops, potentially at any point in an instruction. When reset is deasserted, execution restarts from the address provided by the reset entry in the vector table. Execution restarts as privileged execution in Thread mode.
NMI	A <i>NonMaskable Interrupt</i> (NMI) can be signalled by a peripheral or triggered by software. This is the highest priority exception other than reset. It is permanently enabled and has a fixed priority of -2. NMIs cannot be: <ul style="list-style-type: none"> Masked or prevented from activation by any other exception Preempted by any exception other than Reset.
Hard fault	A hard fault is an exception that occurs because of an error during exception processing, or because an exception cannot be managed by any other exception mechanism. Hard faults have a fixed priority of -1, meaning they have higher priority than any exception with configurable priority.
Memory management fault	A memory management fault is an exception that occurs because of a memory protection related fault. The fixed memory protection constraints determines this fault, for both instruction and data memory transactions. This fault is used to abort instruction accesses to <i>Execute Never</i> (XN) memory regions.

Bus fault	A bus fault is an exception that occurs because of a memory related fault for an instruction or data memory transaction. This might be from an error detected on a bus in the memory system.
Usage fault	<p>A usage fault is an exception that occurs because of a fault related to instruction execution. This includes:</p> <ul style="list-style-type: none"> • An undefined instruction • An illegal unaligned access • Invalid state on instruction execution • An error on exception return. <p>The following can cause a usage fault when the core is configured to report them:</p> <ul style="list-style-type: none"> • An unaligned address on word and halfword memory access • Division by zero
SVCall	A <i>supervisor call</i> (SVC) is an exception that is triggered by the SVC instruction. In an OS environment, applications can use SVC instructions to access OS kernel functions and device drivers.
PendSV	PendSV is an interrupt-driven request for system-level service. In an OS environment, use PendSV for context switching when no other exception is active.
SysTick	A SysTick exception is an exception the system timer generates when it reaches zero. Software can also generate a SysTick exception. In an OS environment, the processor can use this exception as system tick.
Interrupt (IRQ)	A interrupt, or IRQ, is an exception signalled by a peripheral, or generated by a software request. All interrupts are asynchronous to instruction execution. In the system, peripherals use interrupts to communicate with the processor.

Table 16. Properties of the different exception types

Exception number ⁽¹⁾	IRQ number ⁽¹⁾	Exception type	Priority	Vector address or offset ⁽²⁾	Activation
1	-	Reset	-3, the highest	0x00000004	Asynchronous
2	-14	NMI	-2	0x00000008	Asynchronous
3	-13	Hard fault	-1	0x0000000C	-
4	-12	Memory management fault	Configurable ⁽³⁾	0x00000010	Synchronous
5	-11	Bus fault	Configurable ⁽³⁾	0x00000014	Synchronous when precise, asynchronous when imprecise
6	-10	Usage fault	Configurable ⁽³⁾	0x00000018	Synchronous
7-10	-	-	-	Reserved	-
11	-5	SVCall	Configurable ⁽³⁾	0x0000002C	Synchronous
12-13	-	-	-	Reserved	-

Table 16. Properties of the different exception types (continued)

Exception number ⁽¹⁾	IRQ number ⁽¹⁾	Exception type	Priority	Vector address or offset ⁽²⁾	Activation
14	-2	PendSV	Configurable ⁽³⁾	0x00000038	Asynchronous
15	-1	SysTick	Configurable ⁽³⁾	0x0000003C	Asynchronous
16-83	0-67	Interrupt (IRQ)	Configurable ⁽⁴⁾	0x00000040 and above ⁽⁵⁾	Asynchronous

1. To simplify the software layer, the CMSIS only uses IRQ numbers and therefore uses negative values for exceptions other than interrupts. The IPSR returns the Exception number, see [Interrupt program status register on page 18](#).
2. See [Vector table on page 36](#) for more information.
3. See [System handler priority registers \(SHPRx\) on page 138](#).
4. See [Interrupt priority registers \(NVIC_IPRx\) on page 125](#).
5. Increasing in steps of 4.

For an asynchronous exception, other than reset, the processor can execute another instruction between when the exception is triggered and when the processor enters the exception handler.

Privileged software can disable the exceptions that [Table 16 on page 34](#) shows as having configurable priority, see:

- [System handler control and state register \(SCB_SHCSR\) on page 140](#)
- [Interrupt clear-enable registers \(NVIC_ICERx\) on page 121](#)

For more information about hard faults, memory management faults, bus faults, and usage faults, see [Section 2.4: Fault handling on page 40](#).

2.3.3 Exception handlers

The processor handles exceptions using:

Interrupt Service Routines (ISRs) Interrupts IRQ0 to IRQ67 are the exceptions handled by ISRs.

Fault handlers Hard fault, memory management fault, usage fault, bus fault are fault exceptions handled by the fault handlers.

System handlers NMI, PendSV, SVCall SysTick, and the fault exceptions are all system exceptions that are handled by system handlers.

2.3.4 Vector table

The vector table contains the reset value of the stack pointer, and the start addresses, also called exception vectors, for all exception handlers. [Figure 12 on page 36](#) shows the order of the exception vectors in the vector table. The least-significant bit of each vector must be 1, indicating that the exception handler is Thumb code.

Figure 12. Vector table

Exception number	IRQ number	Offset	Vector
83	67	0x014C	IRQ67
.	.	.	.
.	.	.	.
.	.	.	.
18	2	0x004C	IRQ2
17	1	0x0048	IRQ1
16	0	0x0044	IRQ0
15	-1	0x0040	Systick
14	-2	0x003C	PendSV
13		0x0038	Reserved
12			Reserved for Debug
11	-5	0x002C	SVCall
10			Reserved
9			
8			
7			
6	-10	0x0018	Usage fault
5	-11	0x0014	Bus fault
4	-12	0x0010	Memory management fault
3	-13	0x000C	Hard fault
2	-14	0x0008	NMI
1		0x0004	Reset
		0x0000	Initial SP value

ai15995

On system reset, the vector table is fixed at address 0x00000000. Privileged software can write to the VTOR to relocate the vector table start address to a different memory location, in the range 0x00000080 to 0x3FFFFFF80, see [Vector table offset register \(SCB_VTOR\) on page 133](#).

2.3.5 Exception priorities

As [Table 16 on page 34](#) shows, all exceptions have an associated priority, with:

- A lower priority value indicating a higher priority
- Configurable priorities for all exceptions except Reset, Hard fault, and NMI.

If software does not configure any priorities, then all exceptions with a configurable priority have a priority of 0. For information about configuring exception priorities see

- [System handler priority registers \(SHPRx\) on page 138](#)
- [Interrupt priority registers \(NVIC_IPRx\) on page 125](#)

Configurable priority values are in the range 0-15. This means that the Reset, Hard fault, and NMI exceptions, with fixed negative priority values, always have higher priority than any other exception.

For example, assigning a higher priority value to IRQ[0] and a lower priority value to IRQ[1] means that IRQ[1] has higher priority than IRQ[0]. If both IRQ[1] and IRQ[0] are asserted, IRQ[1] is processed before IRQ[0].

If multiple pending exceptions have the same priority, the pending exception with the lowest exception number takes precedence. For example, if both IRQ[0] and IRQ[1] are pending and have the same priority, then IRQ[0] is processed before IRQ[1].

When the processor is executing an exception handler, the exception handler is preempted if a higher priority exception occurs. If an exception occurs with the same priority as the exception being handled, the handler is not preempted, irrespective of the exception number. However, the status of the new interrupt changes to pending.

2.3.6 Interrupt priority grouping

To increase priority control in systems with interrupts, the NVIC supports priority grouping. This divides each interrupt priority register entry into two fields:

- An upper field that defines the *group priority*
- A lower field that defines a *subpriority* within the group.

Only the group priority determines preemption of interrupt exceptions. When the processor is executing an interrupt exception handler, another interrupt with the same group priority as the interrupt being handled does not preempt the handler,

If multiple pending interrupts have the same group priority, the subpriority field determines the order in which they are processed. If multiple pending interrupts have the same group priority and subpriority, the interrupt with the lowest IRQ number is processed first.

For information about splitting the interrupt priority fields into group priority and subpriority, see [Application interrupt and reset control register \(SCB_AIRCR\) on page 134](#).

2.3.7 Exception entry and return

Descriptions of exception handling use the following terms:

Preemption	<p>When the processor is executing an exception handler, an exception can preempt the exception handler if its priority is higher than the priority of the exception being handled. See Section 2.3.6: Interrupt priority grouping for more information about preemption by an interrupt.</p> <p>When one exception preempts another, the exceptions are called nested exceptions. See Exception entry on page 38 more information.</p>
Return	<p>This occurs when the exception handler is completed, and:</p> <ul style="list-style-type: none">• There is no pending exception with sufficient priority to be serviced• The completed exception handler was not handling a late-arriving exception. <p>The processor pops the stack and restores the processor state to the state it had before the interrupt occurred. See Exception return on page 39 for more information.</p>
Tail-chaining	<p>This mechanism speeds up exception servicing. On completion of an exception handler, if there is a pending exception that meets the requirements for exception entry, the stack pop is skipped and control transfers to the new exception handler.</p>
Late-arriving	<p>This mechanism speeds up preemption. If a higher priority exception occurs during state saving for a previous exception, the processor switches to handle the higher priority exception and initiates the vector fetch for that exception. State saving is not affected by late arrival because the state saved is the same for both exceptions. Therefore the state saving continues uninterrupted. The processor can accept a late arriving exception until the first instruction of the exception handler of the original exception enters the execute stage of the processor. On return from the exception handler of the late-arriving exception, the normal tail-chaining rules apply.</p>

Exception entry

Exception entry occurs when there is a pending exception with sufficient priority and either:

- The processor is in Thread mode
- The new exception is of higher priority than the exception being handled, in which case the new exception preempts the original exception.

When one exception preempts another, the exceptions are nested.

Sufficient priority means the exception has more priority than any limits set by the mask registers, see [Exception mask registers on page 19](#). An exception with less priority than this is pending but is not handled by the processor.

When the processor takes an exception, unless the exception is a tail-chained or a late-arriving exception, the processor pushes information onto the current stack. This operation

is referred as *stacking* and the structure of eight data words is referred as *stack frame*. The stack frame contains the following information:

- R0-R3, R12
- Return address
- PSR
- LR.

Immediately after stacking, the stack pointer indicates the lowest address in the stack frame. Unless stack alignment is disabled, the stack frame is aligned to a double-word address. If the STKALIGN bit of the *Configuration Control Register* (CCR) is set to 1, stack align adjustment is performed during stacking.

The stack frame includes the return address. This is the address of the next instruction in the interrupted program. This value is restored to the PC at exception return so that the interrupted program resumes.

In parallel to the stacking operation, the processor performs a vector fetch that reads the exception handler start address from the vector table. When stacking is complete, the processor starts executing the exception handler. At the same time, the processor writes an EXC_RETURN value to the LR. This indicates which stack pointer corresponds to the stack frame and what operation mode the was processor was in before the entry occurred.

If no higher priority exception occurs during exception entry, the processor starts executing the exception handler and automatically changes the status of the corresponding pending interrupt to active.

If another higher priority exception occurs during exception entry, the processor starts executing the exception handler for this exception and does not change the pending status of the earlier exception. This is the late arrival case.

Exception return

Exception return occurs when the processor is in Handler mode and executes one of the following instructions to load the EXC_RETURN value into the PC:

- A POP instruction that includes the PC
- A BX instruction with any register.
- An LDR or LDM instruction with the PC as the destination

EXC_RETURN is the value loaded into the LR on exception entry. The exception mechanism relies on this value to detect when the processor has completed an exception handler. The lowest four bits of this value provide information on the return stack and processor mode. [Table 17](#) shows the EXC_RETURN[3:0] values with a description of the exception return behavior.

The processor sets EXC_RETURN bits[31:4] to 0xFFFFFFFF. When this value is loaded into the PC it indicates to the processor that the exception is complete, and the processor initiates the exception return sequence.

Table 17. Exception return behavior

EXC_RETURN[3:0]	Description
0bxxx0	Reserved.
0b0001	Return to Handler mode. Exception return gets state from MSP. Execution uses MSP after return.
0b0011	Reserved.
0b01x1	Reserved.
0b1001	Return to Thread mode. Exception return gets state from MSP. Execution uses MSP after return.
0b1101	Return to Thread mode. Exception return gets state from PSP. Execution uses PSP after return.
0b1x11	Reserved.

2.4 Fault handling

Faults are a subset of the exceptions, see [Exception model on page 33](#). The following generate a fault:

- A bus error on:
 - An instruction fetch or vector table load
 - A data access
- An internally-detected error such as an undefined instruction or an attempt to change state with a BX instruction
- Attempting to execute an instruction from a memory region marked as *Non-Executable* (XN).

2.4.1 Fault types

[Table 18](#) shows the types of fault, the handler used for the fault, the corresponding fault status register, and the register bit that indicates that the fault has occurred. See [Configurable fault status register \(SCB_CFSR\) on page 142](#) for more information about the fault status registers.

Table 18. Faults

Fault	Handler	Bit name	Fault status register
Bus error on a vector read	Hard fault	VECTTBL	Hard fault status register (SCB_HFSR) on page 145
Fault escalated to a hard fault		FORCED	

Table 18. Faults (continued)

Fault	Handler	Bit name	Fault status register
Bus error:	Bus fault	-	-
During exception stacking		STKERR	<i>Configurable fault status register (SCB_CFSR) on page 142</i>
During exception unstacking		UNSTKERR	
During instruction prefetch		IBUSERR	
Precise data bus error		PRECISERR	
Imprecise data bus error		IMPRECISERR	
Attempt to access a coprocessor	Usage fault	NOCP	
Undefined instruction		UNDEFINSTR	
Attempt to enter an invalid instruction set state ⁽¹⁾		INVSTATE	
Invalid EXC_RETURN value		INVPC	
Illegal unaligned load or store		UNALIGNED	
Divide By 0		DIVBYZERO	

1. Attempting to use an instruction set other than the Thumb instruction set.

2.4.2 Fault escalation and hard faults

All faults exceptions except for hard fault have configurable exception priority, see [System handler priority registers \(SHPRx\) on page 138](#). Software can disable execution of the handlers for these faults, see [System handler control and state register \(SCB_SHCSR\) on page 140](#).

Usually, the exception priority, together with the values of the exception mask registers, determines whether the processor enters the fault handler, and whether a fault handler can preempt another fault handler. as described in [Section 2.3: Exception model on page 33](#).

In some situations, a fault with configurable priority is treated as a hard fault. This is called *priority escalation*, and the fault is described as *escalated to hard fault*. Escalation to hard fault occurs when:

- A fault handler causes the same kind of fault as the one it is servicing. This escalation to hard fault occurs because a fault handler cannot preempt itself because it must have the same priority as the current priority level.
- A fault handler causes a fault with the same or lower priority as the fault it is servicing. This is because the handler for the new fault cannot preempt the currently executing fault handler.
- An exception handler causes a fault for which the priority is the same as or lower than the currently executing exception.
- A fault occurs and the handler for that fault is not enabled.

If a bus fault occurs during a stack push when entering a bus fault handler, the bus fault does not escalate to a hard fault. This means that if a corrupted stack causes a fault, the fault handler executes even though the stack push for the handler failed. The fault handler operates but the stack contents are corrupted.

Only Reset and NMI can preempt the fixed priority hard fault. A hard fault can preempt any exception other than Reset, NMI, or another hard fault.

2.4.3 Fault status registers and fault address registers

The fault status registers indicate the cause of a fault. For bus faults and memory management faults, the fault address register indicates the address accessed by the operation that caused the fault, as shown in [Table 19](#).

Table 19. Fault status and fault address registers

Handler	Status register name	Address register name	Register description
Hard fault	HFSR	-	Hard fault status register (SCB_HFSR) on page 145
Memory management fault	MMFSR	MMFAR	Configurable fault status register (SCB_CFSR) on page 142 Memory management fault address register (SCB_MMFAR) on page 147
Bus fault	BFSR	BFAR	Configurable fault status register (SCB_CFSR) on page 142 Bus fault address register (SCB_BFAR) on page 147
Usage fault	UFSR	-	Configurable fault status register (SCB_CFSR) on page 142

2.4.4 Lockup

The processor enters a lockup state if a hard fault occurs when executing the NMI or hard fault handlers. When the processor is in lockup state it does not execute any instructions. The processor remains in lockup state until either:

- It is reset
- An NMI occurs

If lockup state occurs from the NMI handler a subsequent NMI does not cause the processor to leave lockup state.

2.5 Power management

The STM32 and Cortex-M3 processor sleep modes reduce power consumption:

- Sleep mode stops the processor clock. All other system and peripheral clocks may still be running.
- Deep sleep mode stops most of the STM32 system and peripheral clocks. At product level, this corresponds to either the Stop or the Standby mode. For more details, please refer to the “Power modes” Section in the STM32 reference manual.

The SLEEPDEEP bit of the SCR selects which sleep mode is used, see [System control register \(SCB_SCR\) on page 136](#). For more information about the behavior of the sleep modes see the STM32 product reference manual.

This section describes the mechanisms for entering sleep mode, and the conditions for waking up from sleep mode.

2.5.1 Entering sleep mode

This section describes the mechanisms software can use to put the processor into sleep mode.

The system can generate spurious wakeup events, for example a debug operation wakes up the processor. Therefore software must be able to put the processor back into sleep mode after such an event. A program might have an idle loop to put the processor back to sleep mode.

Wait for interrupt

The *wait for interrupt* instruction, WFI, causes immediate entry to sleep mode. When the processor executes a WFI instruction it stops executing instructions and enters sleep mode. See [WFI on page 104](#) for more information.

Wait for event

The *wait for event* instruction, WFE, causes entry to sleep mode conditional on the value of an one-bit event register. When the processor executes a WFE instruction, it checks this register:

- If the register is 0 the processor stops executing instructions and enters sleep mode
- If the register is 1 the processor clears the register to 0 and continues executing instructions without entering sleep mode.

See [WFE on page 103](#) for more information.

If the event register is 1, this indicate that the processor must not enter sleep mode on execution of a WFE instruction. Typically, this is because an external event signal is asserted, or a processor in the system has executed an SEV instruction, see [SEV on page 102](#). Software cannot access this register directly.

Sleep-on-exit

If the SLEEPONEXIT bit of the SCR is set to 1, when the processor completes the execution of an exception handler it returns to Thread mode and immediately enters sleep mode. Use this mechanism in applications that only require the processor to run when an exception occurs.

2.5.2 Wakeup from sleep mode

The conditions for the processor to wakeup depend on the mechanism that cause it to enter sleep mode.

Wakeup from WFI or sleep-on-exit

Normally, the processor wakes up only when it detects an exception with sufficient priority to cause exception entry.

Some embedded systems might have to execute system restore tasks after the processor wakes up, and before it executes an interrupt handler. To achieve this set the PRIMASK bit to 1 and the FAULTMASK bit to 0. If an interrupt arrives that is enabled and has a higher priority than current exception priority, the processor wakes up but does not execute the interrupt handler until the processor sets PRIMASK to zero. For more information about PRIMASK and FAULTMASK see [Exception mask registers on page 19](#).

Wakeup from WFE

The processor wakes up if:

- it detects an exception with sufficient priority to cause exception entry
- it detects an external event signal, see [The external event input on page 44](#)

In addition, if the SEVONPEND bit in the SCR is set to 1, any new pending interrupt triggers an event and wakes up the processor, even if the interrupt is disabled or has insufficient priority to cause exception entry. For more information about the SCR see [System control register \(SCB_SCR\) on page 136](#).

2.5.3 The external event input

The processor provides an external event input signal. This signal can be generated by the up to 16 external input lines, by the PVD, RTC alarm or by the USB wakeup event, configured through the external interrupt/event controller (EXTI).

This signal can wakeup the processor from WFE, or set the internal WFE event register to one to indicate that the processor must not enter sleep mode on a later WFE instruction, see [Wait for event on page 43](#). For more details please refer to the STM32 reference manual, section 4.3 Low power modes.

2.5.4 Power management programming hints

ANSI C cannot directly generate the WFI and WFE instructions. The CMSIS provides the following intrinsic functions for these instructions:

```
void __WFE(void) // Wait for Event
void __WFI(void) // Wait for Interrupt
```

3 The Cortex-M3 instruction set

3.1 Instruction set summary

The processor implements a version of the thumb instruction set. [Table 20](#) lists the supported instructions.

In [Table 20](#):

- Angle brackets, <>, enclose alternative forms of the operand
- Braces, {}, enclose optional operands
- The operands column is not exhaustive
- Op2 is a flexible second operand that can be either a register or a constant
- Most instructions can use an optional condition code suffix

For more information on the instructions and operands, see the instruction descriptions.

Table 20. Cortex-M3 instructions

Mnemonic	Operands	Brief description	Flags	Section
ADC, ADCS	{Rd,} Rn, Op2	Add with carry	N,Z,C,V	3.5.1 on page 73
ADD, ADDS	{Rd,} Rn, Op2	Add	N,Z,C,V	3.5.1 on page 73
ADD, ADDW	{Rd,} Rn, #imm12	Add	N,Z,C,V	3.5.1 on page 73
ADR	Rd, label	Load PC-relative address	—	3.4.1 on page 60
AND, ANDS	{Rd,} Rn, Op2	Logical AND	N,Z,C	3.5.2 on page 75
ASR, ASRS	Rd, Rm, <Rs #n>	Arithmetic shift right	N,Z,C	3.5.3 on page 76
B	label	Branch	—	3.8.5 on page 92
BFC	Rd, #lsb, #width	Bit field clear	—	3.8.1 on page 89
BFI	Rd, Rn, #lsb, #width	Bit field insert	—	3.8.1 on page 89
BIC, BICS	{Rd,} Rn, Op2	Bit clear	N,Z,C	3.5.2 on page 75
BKPT	#imm	Breakpoint	—	3.9.1 on page 98
BL	label	Branch with link	—	3.8.5 on page 92
BLX	Rm	Branch indirect with link	—	3.8.5 on page 92

Table 20. Cortex-M3 instructions (continued)

Mnemonic	Operands	Brief description	Flags	Section
BX	Rm	Branch indirect	—	3.8.5 on page 92
CBNZ	Rn, label	Compare and branch if non zero	—	3.8.6 on page 93
CBZ	Rn, label	Compare and branch if zero	—	3.8.6 on page 93
CLREX	—	Clear exclusive	—	3.4.9 on page 71
CLZ	Rd, Rm	Count leading zeros	—	3.5.4 on page 77
CMN, CMNS	Rn, Op2	Compare negative	N,Z,C,V	3.5.5 on page 78
CMP, CMPS	Rn, Op2	Compare	N,Z,C,V	3.5.5 on page 78
CPSID	iflags	Change processor state, disable interrupts	—	3.9.2 on page 98
CPSIE	iflags	Change processor state, enable interrupts	—	3.9.2 on page 98
DMB	—	Data memory barrier	—	3.9.4 on page 100
DSB	—	Data synchronization barrier	—	3.9.4 on page 100
EOR, EORS	{Rd,} Rn, Op2	Exclusive OR	N,Z,C	3.5.2 on page 75
ISB	—	Instruction synchronization barrier	—	3.9.5 on page 100
IT	—	If-then condition block	—	3.8.7 on page 94
LDM	Rn{!}, reglist	Load multiple registers, increment after	—	3.4.6 on page 67
LDMDB, LDMEA	Rn{!}, reglist	Load multiple registers, decrement before	—	3.4.6 on page 67
LDMFD, LDMIA	Rn{!}, reglist	Load multiple registers, increment after	—	3.4.6 on page 67
LDR	Rt, [Rn, #offset]	Load register with word	—	3.4 on page 60
LDRB, LDRBT	Rt, [Rn, #offset]	Load register with byte	—	3.4 on page 60
LDRD	Rt, Rt2, [Rn, #offset]	Load register with two bytes	—	3.4.2 on page 61
LDREX	Rt, [Rn, #offset]	Load register exclusive	—	3.4.8 on page 70

Table 20. Cortex-M3 instructions (continued)

Mnemonic	Operands	Brief description	Flags	Section
LDREXB	Rt, [Rn]	Load register exclusive with byte	—	3.4.8 on page 70
LDREXH	Rt, [Rn]	Load register exclusive with halfword	—	3.4.8 on page 70
LDRH, LDRHT	Rt, [Rn, #offset]	Load register with halfword	—	3.4 on page 60
LDRSB, LDRSBT	Rt, [Rn, #offset]	Load register with signed byte	—	3.4 on page 60
LDRSH, LDRSHT	Rt, [Rn, #offset]	Load register with signed halfword	—	3.4 on page 60
LDRT	Rt, [Rn, #offset]	Load register with word	—	3.4 on page 60
LSL, LSLS	Rd, Rm, <Rs #n>	Logical shift left	N,Z,C	3.5.3 on page 76
LSR, LSRS	Rd, Rm, <Rs #n>	Logical shift right	N,Z,C	3.5.3 on page 76
MLA	Rd, Rn, Rm, Ra	Multiply with accumulate, 32-bit result	—	3.6.1 on page 83
MLS	Rd, Rn, Rm, Ra	Multiply and subtract, 32-bit result	—	3.6.1 on page 83
MOV, MOVS	Rd, Op2	Move	N,Z,C	3.5.6 on page 79
MOVT	Rd, #imm16	Move top	—	3.5.7 on page 80
MOVW, MOV	Rd, #imm16	Move 16-bit constant	N,Z,C	3.5.6 on page 79
MRS	Rd, spec_reg	Move from special register to general register	—	3.9.6 on page 100
MSR	spec_reg, Rm	Move from general register to special register	N,Z,C,V	3.9.7 on page 101
MUL, MULS	{Rd,} Rn, Rm	Multiply, 32-bit result	N,Z	3.6.1 on page 83
MVN, MVNS	Rd, Op2	Move NOT	N,Z,C	3.5.6 on page 79
NOP	—	No operation	—	3.9.8 on page 102
ORN, ORNS	{Rd,} Rn, Op2	Logical OR NOT	N,Z,C	3.5.2 on page 75
ORR, ORRS	{Rd,} Rn, Op2	Logical OR	N,Z,C	3.5.2 on page 75
POP	reglist	Pop registers from stack	—	3.4.7 on page 68

Table 20. Cortex-M3 instructions (continued)

Mnemonic	Operands	Brief description	Flags	Section
PUSH	reglist	Push registers onto stack	—	3.4.7 on page 68
RBIT	Rd, Rn	Reverse bits	—	3.5.8 on page 81
REV	Rd, Rn	Reverse byte order in a word	—	3.5.8 on page 81
REV16	Rd, Rn	Reverse byte order in each halfword	—	3.5.8 on page 81
REVSH	Rd, Rn	Reverse byte order in bottom halfword and sign extend	—	3.5.8 on page 81
ROR, RORS	Rd, Rm, <Rn>#n	Rotate right	N,Z,C	3.5.3 on page 76
RRX, RRXS	Rd, Rm	Rotate right with extend	N,Z,C	3.5.3 on page 76
RSB, RSBS	{Rd,} Rn, Op2	Reverse subtract	N,Z,C,V	3.5.1 on page 73
SBC, SBCS	{Rd,} Rn, Op2	Subtract with carry	N,Z,C,V	3.5.1 on page 73
SBFX	Rd, Rn, #lsb, #width	Signed bit field extract	—	3.8.2 on page 89
SDIV	{Rd,} Rn, Rm	Signed divide	—	3.6.3 on page 86
SEV	—	Send event	—	3.9.9 on page 102
SMLAL	RdLo, RdHi, Rn, Rm	Signed multiply with accumulate (32 x 32 + 64), 64-bit result	—	3.6.2 on page 85
SMULL	RdLo, RdHi, Rn, Rm	Signed multiply (32 x 32), 64-bit result	—	3.6.2 on page 85
SSAT	Rd, #n, Rm {,shift #s}	Signed saturate	Q	3.7.1 on page 87
STM	Rn{!}, reglist	Store multiple registers, increment after	—	3.4.6 on page 67
STMDB, STMEA	Rn{!}, reglist	Store multiple registers, decrement before	—	3.4.6 on page 67
STMFD, STMIA	Rn{!}, reglist	Store multiple registers, increment after	—	3.4.6 on page 67
STR	Rt, [Rn, #offset]	Store register word	—	3.4 on page 60
STRB, STRBT	Rt, [Rn, #offset]	Store register byte	—	3.4 on page 60
STRD	Rt, Rt2, [Rn, #offset]	Store register two words	—	3.4.2 on page 61

Table 20. Cortex-M3 instructions (continued)

Mnemonic	Operands	Brief description	Flags	Section
STREX	Rd, Rt, [Rn, #offset]	Store register exclusive	—	3.4.8 on page 70
STREXB	Rd, Rt, [Rn]	Store register exclusive byte	—	3.4.8 on page 70
STREXH	Rd, Rt, [Rn]	Store register exclusive halfword	—	3.4.8 on page 70
STRH, STRHT	Rt, [Rn, #offset]	Store register halfword	—	3.4 on page 60
STRT	Rt, [Rn, #offset]	Store register word	—	3.4 on page 60
SUB, SUBS	{Rd,} Rn, Op2	Subtract	N,Z,C,V	3.5.1 on page 73
SUB, SUBW	{Rd,} Rn, #imm12	Subtract	N,Z,C,V	3.5.1 on page 73
SVC	#imm	Supervisor call	—	3.9.10 on page 103
SXTB	{Rd,} Rm {,ROR #n}	Sign extend a byte	—	3.8.3 on page 90
SXTH	{Rd,} Rm {,ROR #n}	Sign extend a halfword	—	3.8.3 on page 90
TBB	[Rn, Rm]	Table branch byte	—	3.8.8 on page 96
TBH	[Rn, Rm, LSL #1]	Table branch halfword	—	3.8.8 on page 96
TEQ	Rn, Op2	Test equivalence	N,Z,C	3.5.9 on page 82
TST	Rn, Op2	Test	N,Z,C	3.5.9 on page 82
UBFX	Rd, Rn, #lsb, #width	Unsigned bit field extract	—	3.8.2 on page 89
UDIV	{Rd,} Rn, Rm	Unsigned divide	—	3.6.3 on page 86
UMLAL	RdLo, RdHi, Rn, Rm	Unsigned multiply with accumulate (32 x 32 + 64), 64-bit result	—	3.6.2 on page 85
UMULL	RdLo, RdHi, Rn, Rm	Unsigned multiply (32 x 32), 64-bit result	—	3.6.2 on page 85
USAT	Rd, #n, Rm {,shift #s}	Unsigned saturate	Q	3.7.1 on page 87
UXTB	{Rd,} Rm {,ROR #n}	Zero extend a byte	—	3.8.3 on page 90
UXTH	{Rd,} Rm {,ROR #n}	Zero extend a halfword	—	3.8.3 on page 90

Table 20. Cortex-M3 instructions (continued)

Mnemonic	Operands	Brief description	Flags	Section
WFE	—	Wait for event	—	3.9.11 on page 103
WFI	—	Wait for interrupt	—	3.9.12 on page 104

3.2 Intrinsic functions

ANSI cannot directly access some Cortex-M3 instructions. This section describes intrinsic functions that can generate these instructions, provided by the CMSIS and that might be provided by a C compiler. If a C compiler does not support an appropriate intrinsic function, you might have to use an inline assembler to access some instructions.

The CMSIS provides the intrinsic functions listed in [Table 21](#) to generate instructions that ANSI cannot directly access.

Table 21. CMSIS intrinsic functions to generate some Cortex-M3 instructions

Instruction	CMSIS intrinsic function
CPSIE I	void __enable_irq(void)
CPSID I	void __disable_irq(void)
CPSIE F	void __enable_fault_irq(void)
CPSID F	void __disable_fault_irq(void)
ISB	void __ISB(void)
DSB	void __DSB(void)
DMB	void __DMB(void)
REV	uint32_t __REV(uint32_t int value)
REV16	uint32_t __REV16(uint32_t int value)
REVSH	uint32_t __REVSH(uint32_t int value)
RBIT	uint32_t __RBIT(uint32_t int value)
SEV	void __SEV(void)
WFE	void __WFE(void)
WFI	void __WFI(void)

The CMSIS also provides a number of functions for accessing the special registers using MRS and MSR instructions (see [Table 22](#)).

Table 22. CMSIS intrinsic functions to access the special registers

Special register	Access	CMSIS function
PRIMASK	Read	uint32_t __get_PRIMASK (void)
	Write	void __set_PRIMASK (uint32_t value)
FAULTMASK	Read	uint32_t __get_FAULTMASK (void)
	Write	void __set_FAULTMASK (uint32_t value)
BASEPRI	Read	uint32_t __get_BASEPRI (void)
	Write	void __set_BASEPRI (uint32_t value)
CONTROL	Read	uint32_t __get_CONTROL (void)
	Write	void __set_CONTROL (uint32_t value)
MSP	Read	uint32_t __get_MSP (void)
	Write	void __set_MSP (uint32_t TopOfMainStack)
PSP	Read	uint32_t __get_PSP (void)
	Write	void __set_PSP (uint32_t TopOfProcStack)

3.3 About the instruction descriptions

The following sections give more information about using the instructions:

- [Operands on page 51](#)
- [Restrictions when using PC or SP on page 52](#)
- [Flexible second operand on page 52](#)
- [Shift operations on page 53](#)
- [Address alignment on page 56](#)
- [PC-relative expressions on page 56](#)
- [Conditional execution on page 57](#)
- [Instruction width selection on page 59](#).

3.3.1 Operands

An instruction operand can be an ARM register, a constant, or another instruction-specific parameter. Instructions act on the operands and often store the result in a destination register. When there is a destination register in the instruction, it is usually specified before the operands.

Operands in some instructions are flexible in that they can either be a register or a constant (see [Flexible second operand](#)).

3.3.2 Restrictions when using PC or SP

Many instructions have restrictions on whether you can use the *program counter* (PC) or *stack pointer* (SP) for the operands or destination register. See instruction descriptions for more information.

Bit[0] of any address written to the PC with a BX, BLX, LDM, LDR, or POP instruction must be 1 for correct execution, because this bit indicates the required instruction set, and the Cortex-M3 processor only supports thumb instructions.

3.3.3 Flexible second operand

Many general data processing instructions have a flexible second operand. This is shown as *operand2* in the descriptions of the syntax of each instruction.

Operand2 can be a:

- [Constant](#)
- [Register with optional shift](#)

Constant

You specify an operand2 constant in the form *#constant*, where *constant* can be:

- Any constant that can be produced by shifting an 8-bit value left by any number of bits within a 32-bit word.
- Any constant of the form 0x00XY00XY
- Any constant of the form 0xXY00XY00
- Any constant of the form 0xXYXYXYXY

In the constants shown above, X and Y are hexadecimal digits.

In addition, in a small number of instructions, *constant* can take a wider range of values. These are described in the individual instruction descriptions.

When an operand2 constant is used with the instructions MOVN, MVNS, ANDS, ORRS, ORNS, EORS, BICS, TEQ or TST, the carry flag is updated to bit[31] of the constant, if the constant is greater than 255 and can be produced by shifting an 8-bit value. These instructions do not affect the carry flag if operand2 is any other constant.

Instruction substitution

Your assembler might be able to produce an equivalent instruction in cases where you specify a constant that is not permitted. For example, an assembler might assemble the instruction `CMP Rd, #0xFFFFFFFF` as the equivalent instruction `CMN Rd, #0x2`.

Register with optional shift

An operand2 register is specified in the form $Rm \{, shift\}$, where:

- Rm is the register holding the data for the second operand
- $Shift$ is an optional shift to be applied to Rm . It can be one of:
 - ASR $\#n$: Arithmetic shift right n bits, $1 \leq n \leq 32$
 - LSL $\#n$: Logical shift left n bits, $1 \leq n \leq 31$
 - LSR $\#n$: Logical shift right n bits, $1 \leq n \leq 32$
 - ROR $\#n$: Rotate right n bits, $1 \leq n \leq 31$
 - RRX: Rotate right one bit, with extend
 - : If omitted, no shift occurs, equivalent to LSL #0

If you omit the shift, or specify LSL #0, the instruction uses the value in Rm .

If you specify a shift, the shift is applied to the value in Rm , and the resulting 32-bit value is used by the instruction. However, the contents in the register Rm remains unchanged. Specifying a register with shift also updates the carry flag when used with certain instructions. For information on the shift operations and how they affect the carry flag, see [Shift operations](#).

3.3.4 Shift operations

Register shift operations move the bits in a register left or right by a specified number of bits, the *shift length*. Register shift can be performed:

- Directly by the instructions ASR, LSR, LSL, ROR, and RRX. The result is written to a destination register.
- During the calculation of operand2 by the instructions that specify the second operand as a register with shift (see [Flexible second operand on page 52](#)). The result is used by the instruction.

The permitted shift lengths depend on the shift type and the instruction (see the individual instruction description or [Flexible second operand](#)). If the shift length is 0, no shift occurs. Register shift operations update the carry flag except when the specified shift length is 0. The following sub-sections describe the various shift operations and how they affect the carry flag. In these descriptions, Rm is the register containing the value to be shifted, and n is the shift length.

ASR

Arithmetic shift right by n bits moves the left-hand $32-n$ bits of the register Rm , to the right by n places, into the right-hand $32-n$ bits of the result. And it copies the original bit[31] of the register into the left-hand n bits of the result (see [Figure 13: ASR#3 on page 54](#)).

You can use the ASR $\#n$ operation to divide the value in the register Rm by 2^n , with the result being rounded towards negative-infinity.

When the instruction is ASRS or when ASR $\#n$ is used in operand2 with the instructions MOVs, MVNS, ANDS, ORRS, ORNS, EORS, BICS, TEQ or TST, the carry flag is updated to the last bit shifted out, bit[$n-1$], of the register Rm .

- Note:*
- 1 If n is 32 or more, all the bits in the result are set to the value of bit[31] of Rm .
 - 2 If n is 32 or more and the carry flag is updated, it is updated to the value of bit[31] of Rm .

Figure 13. ASR#3

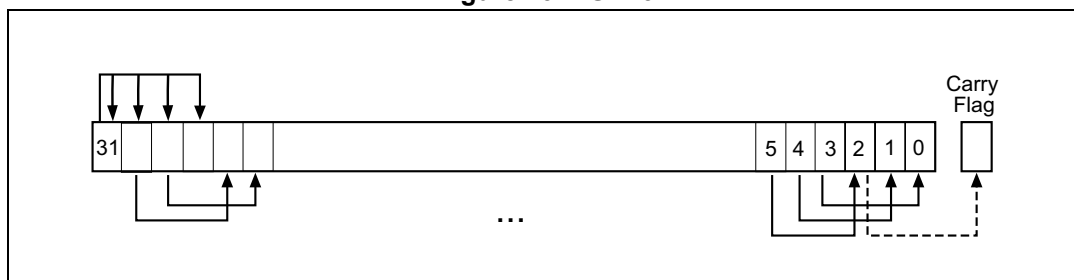

LSR

Logical shift right by n bits moves the left-hand $32-n$ bits of the register Rm , to the right by n places, into the right-hand $32-n$ bits of the result. And it sets the left-hand n bits of the result to 0 (see [Figure 14](#)).

You can use the LSR # n operation to divide the value in the register Rm by 2^n , if the value is regarded as an unsigned integer.

When the instruction is LSRS or when LSR # n is used in *operand2* with the instructions MOV_S, MVNS, AND_S, ORR_S, ORN_S, EOR_S, BIC_S, TEQ or TST, the carry flag is updated to the last bit shifted out, bit[$n-1$], of the register Rm .

- Note:
- 1 If n is 32 or more, then all the bits in the result are cleared to 0.
 - 2 If n is 33 or more and the carry flag is updated, it is updated to 0.

Figure 14. LSR#3

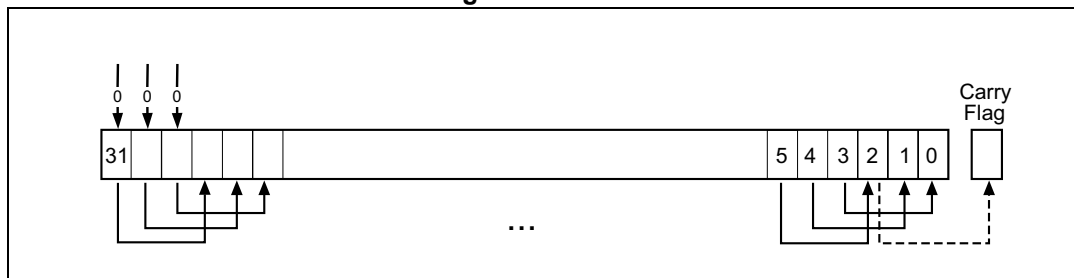

LSL

Logical shift left by n bits moves the right-hand $32-n$ bits of the register Rm , to the left by n places, into the left-hand $32-n$ bits of the result. And it sets the right-hand n bits of the result to 0 (see [Figure 15: LSL#3 on page 55](#)).

You can use the LSL # n operation to multiply the value in the register Rm by 2^n , if the value is regarded as an unsigned integer or a two's complement signed integer. Overflow can occur without warning.

When the instruction is LSLS or when LSL # n , with non-zero n , is used in *operand2* with the instructions MOV_S, MVNS, AND_S, ORR_S, ORN_S, EOR_S, BIC_S, TEQ or TST, the carry flag is updated to the last bit shifted out, bit[$32-n$], of the register Rm . These instructions do not affect the carry flag when used with LSL #0.

- Note: 1 If n is 32 or more, then all the bits in the result are cleared to 0.
 2 If n is 33 or more and the carry flag is updated, it is updated to 0.

Figure 15. LSL#3

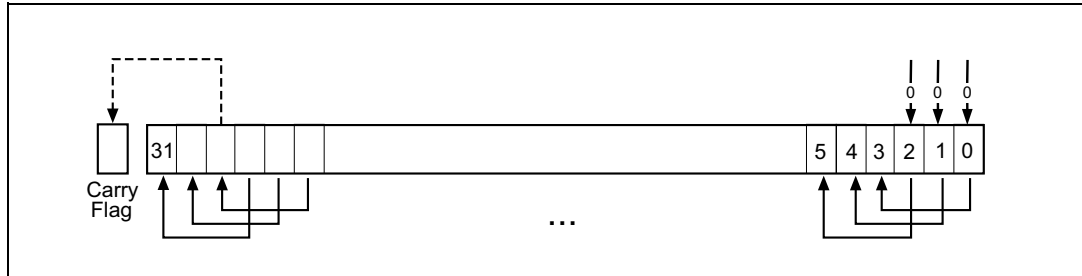

ROR

Rotate right by n bits moves the left-hand $32-n$ bits of the register Rm , to the right by n places, into the right-hand $32-n$ bits of the result. It also moves the right-hand n bits of the register into the left-hand n bits of the result (see Figure 16).

When the instruction is RORS or when ROR # n is used in *operand2* with the instructions MOV_S, MVNS, AND_S, ORR_S, ORN_S, EOR_S, BIC_S, TEQ or TST, the carry flag is updated to the last bit rotation, bit[$n-1$], of the register Rm .

- Note: 1 If n is 32, then the value of the result is same as the value in Rm , and if the carry flag is updated, it is updated to bit[31] of Rm .
 2 ROR with shift length, n , more than 32 is the same as ROR with shift length $n-32$.

Figure 16. ROR #3

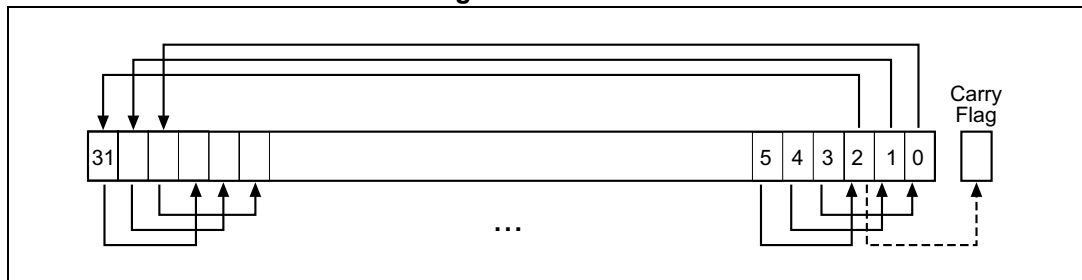

RRX

Rotate right with extend moves the bits of the register Rm to the right by one bit. And it copies the carry flag into bit[31] of the result (see Figure 17).

When the instruction is RRXS or when RRX is used in *operand2* with the instructions MOV_S, MVNS, AND_S, ORR_S, ORN_S, EOR_S, BIC_S, TEQ or TST, the carry flag is updated to bit[0] of the register Rm .

Figure 17. RRX #3

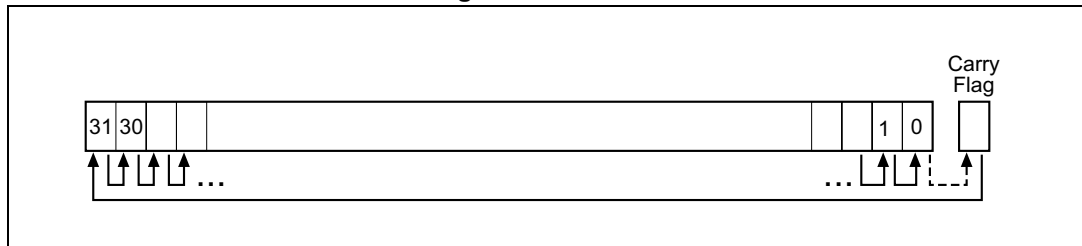

3.3.5 Address alignment

An aligned access is an operation where a word-aligned address is used for a word, dual word, or multiple word access, or where a halfword-aligned address is used for a halfword access. Byte accesses are always aligned.

The Cortex-M3 processor supports unaligned access only for the following instructions:

- LDR, LDRT
- LDRH, LDRHT
- LDRSH, LDRSHT
- STR, STRT
- STRH, STRHT

All other load and store instructions generate a usage fault exception if they perform an unaligned access, and therefore their accesses must be address aligned. For more information about usage faults see [Fault handling on page 40](#).

Unaligned accesses are usually slower than aligned accesses. In addition, some memory regions might not support unaligned accesses. Therefore, ARM recommends that programmers ensure that accesses are aligned. To avoid accidental generation of unaligned accesses, use the UNALIGN_TRP bit in the configuration and control register to trap all unaligned accesses, see [Configuration and control register \(SCB_CCR\) on page 137](#).

3.3.6 PC-relative expressions

A PC-relative expression or *label* is a symbol that represents the address of an instruction or literal data. It is represented in the instruction as the PC value plus or minus a numeric offset. The assembler calculates the required offset from the label and the address of the current instruction. If the offset is too big, the assembler produces an error.

- For the B, BL, CBNZ, and CBZ instructions, the value of the PC is the address of the current instruction plus four bytes.
- For all other instructions that use labels, the value of the PC is the address of the current instruction plus four bytes, with bit[1] of the result cleared to 0 to make it word-aligned.
- Your assembler might permit other syntaxes for PC-relative expressions, such as a label plus or minus a number, or an expression of the form [PC, #number].

3.3.7 Conditional execution

Most data processing instructions can optionally update the condition flags in the *application program status register* (APSR) according to the result of the operation (see [Application program status register on page 17](#)). Some instructions update all flags, and some only update a subset. If a flag is not updated, the original value is preserved. See the instruction descriptions for the flags they affect.

You can execute an instruction conditionally, based on the condition flags set in another instruction:

- Immediately after the instruction that updated the flags
- After any number of intervening instructions that have not updated the flags

Conditional execution is available by using conditional branches or by adding condition code suffixes to instructions. See [Table 23: Condition code suffixes on page 58](#) for a list of the suffixes to add to instructions to make them conditional instructions. The condition code suffix enables the processor to test a condition based on the flags. If the condition test of a conditional instruction fails, the instruction:

- Does not execute
- Does not write any value to its destination register
- Does not affect any of the flags
- Does not generate any exception

Conditional instructions, except for conditional branches, must be inside an If-then instruction block. See [IT on page 94](#) for more information and restrictions when using the IT instruction. Depending on the vendor, the assembler might automatically insert an IT instruction if you have conditional instructions outside the IT block.

Use the CBZ and CBNZ instructions to compare the value of a register against zero and branch on the result.

This section describes:

- [The condition flags](#)
- [Condition code suffixes on page 58](#)

The condition flags

The APSR contains the following condition flags:

- N: Set to 1 when the result of the operation is negative, otherwise cleared to 0
- Z: Set to 1 when the result of the operation is zero, otherwise cleared to 0
- C: Set to 1 when the operation results in a carry, otherwise cleared to 0.
- V: Set to 1 when the operation causes an overflow, otherwise cleared to 0.

For more information about the APSR see [Program status register on page 16](#).

A carry occurs:

- If the result of an addition is greater than or equal to 2^{32}
- If the result of a subtraction is positive or zero
- As the result of an inline barrel shifter operation in a move or logical instruction

Overflow occurs if the result of an add, subtract, or compare is greater than or equal to 2^{31} , or less than -2^{31} .

Most instructions update the status flags only if the S suffix is specified. See the instruction descriptions for more information.

Condition code suffixes

The instructions that can be conditional have an optional condition code, shown in syntax descriptions as {*cond*}. Conditional execution requires a preceding IT instruction. An instruction with a condition code is only executed if the condition code flags in the APSR meet the specified condition. [Table 23](#) shows the condition codes to use.

You can use conditional execution with the IT instruction to reduce the number of branch instructions in code.

[Table 23](#) also shows the relationship between condition code suffixes and the N, Z, C, and V flags.

Table 23. Condition code suffixes

Suffix	Flags	Meaning
EQ	Z = 1	Equal
NE	Z = 0	Not equal
CS or HS	C = 1	Higher or same, unsigned ≥
CC or LO	C = 0	Lower, unsigned <
MI	N = 1	Negative
PL	N = 0	Positive or zero
VS	V = 1	Overflow
VC	V = 0	No overflow
HI	C = 1 and Z = 0	Higher, unsigned >
LS	C = 0 or Z = 1	Lower or same, unsigned ≤
GE	N = V	Greater than or equal, signed ≥
LT	N != V	Less than, signed <
GT	Z = 0 and N = V	Greater than, signed >
LE	Z = 1 and N != V	Less than or equal, signed ≤
AL	Can have any value	Always. This is the default when no suffix is specified.

[Specific example 1: Absolute value](#) shows the use of a conditional instruction to find the absolute value of a number. R0 = ABS(R1).

Specific example 1: Absolute value

```

MOVSR0, R1; R0 = R1, setting flags
IT MI; IT instruction for the negative condition
RSBMR0, R1, #0; If negative, R0 = -R1
    
```



Specific example 2: Compare and update value shows the use of conditional instructions to update the value of R4 if the signed value R0 and R2 are greater than R1 and R3 respectively.

Specific example 2: Compare and update value

```
CMP R0, R1 ; compare R0 and R1, setting flags
ITT GT ; IT instruction for the two GT conditions
CMPGT R2, R3; if 'greater than', compare R2 and R3, setting flags
MOVGT R4, R5 ; if still 'greater than', do R4 = R5
```

3.3.8 Instruction width selection

There are many instructions that can generate either a 16-bit encoding or a 32-bit encoding depending on the operands and destination register specified. For some of these instructions, you can force a specific instruction size by using an instruction width suffix. The `.W` suffix forces a 32-bit instruction encoding. The `.N` suffix forces a 16-bit instruction encoding.

If you specify an instruction width suffix and the assembler cannot generate an instruction encoding of the requested width, it generates an error.

In some cases it might be necessary to specify the `.W` suffix, for example if the operand is the label of an instruction or literal data, as in the case of branch instructions. This is because the assembler might not automatically generate the right size encoding.

To use an instruction width suffix, place it immediately after the instruction mnemonic and condition code, if any. *Specific example 3: Instruction width selection* shows instructions with the instruction width suffix.

Specific example 3: Instruction width selection

```
BCS.W label; creates a 32-bit instruction even for a short branch
ADDS.W R0, R0, R1; creates a 32-bit instruction even though the same
; operation can be done by a 16-bit instruction
```

3.4 Memory access instructions

[Table 24](#) shows the memory access instructions:

Table 24. Memory access instructions

Mnemonic	Brief description	Section
ADR	Load PC-relative address	ADR on page 60
CLREX	Clear exclusive	CLREX on page 71
LDM{mode}	Load multiple registers	LDM and STM on page 67
LDR{type}	Load register using immediate offset	LDR and STR, immediate offset on page 61
LDR{type}	Load register using register offset	LDR and STR, register offset on page 63
LDR{type}T	Load register with unprivileged access	LDR and STR, unprivileged on page 64
LDR	Load register using PC-relative address	LDR, PC-relative on page 65
LDREX{type}	Load register exclusive	LDREX and STREX on page 70
POP	Pop registers from stack	PUSH and POP on page 68
PUSH	Push registers onto stack	PUSH and POP on page 68
STM{mode}	Store multiple registers	LDM and STM on page 67
STR{type}	Store register using immediate offset	LDR and STR, immediate offset on page 61
STR{type}	Store register using register offset	LDR and STR, register offset on page 63
STR{type}T	Store register with unprivileged access	LDR and STR, unprivileged on page 64
STREX{type}	Store register exclusive	LDREX and STREX on page 70

3.4.1 ADR

Load PC-relative address.

Syntax

```
ADR{cond} Rd, label
```

where:

- '*cond*' is an optional condition code (see [Conditional execution on page 57](#))
- '*Rd*' is the destination register
- '*label*' is a PC-relative expression (see [PC-relative expressions on page 56](#))

Operation

ADR determines the address by adding an immediate value to the PC. It writes the result to the destination register.

ADR produces position-independent code, because the address is PC-relative.

If you use ADR to generate a target address for a BX or BLX instruction, you must ensure that bit[0] of the address you generate is set to 1 for correct execution.

Values of *label* must be within the range -4095 to 4095 from the address in the PC.

Note: You might have to use the *.W* suffix to get the maximum offset range or to generate addresses that are not word-aligned (see [Instruction width selection on page 59](#)).

Restrictions

Rd must be neither SP nor PC.

Condition flags

This instruction does not change the flags.

Examples

```
ADR R1, TextMessage; write address value of a location labelled as
; TextMessage to R1
```

3.4.2 LDR and STR, immediate offset

Load and store with immediate offset, pre-indexed immediate offset, or post-indexed immediate offset.

Syntax

```
op{type}{cond} Rt, [Rn {, #offset}]; immediate offset
op{type}{cond} Rt, [Rn, #offset]!; pre-indexed
op{type}{cond} Rt, [Rn], #offset; post-indexed
opD{cond} Rt, Rt2, [Rn {, #offset}]; immediate offset, two words
opD{cond} Rt, Rt2, [Rn, #offset]!; pre-indexed, two words
opD{cond} Rt, Rt2, [Rn], #offset; post-indexed, two words
```

where:

- ‘*op*’ is either LDR (load register) or STR (store register)
- ‘*type*’ is one of the following:
 - B: Unsigned byte, zero extends to 32 bits on loads
 - SB: Signed byte, sign extends to 32 bits (LDR only)
 - H: Unsigned halfword, zero extends to 32 bits on loads
 - SH: Signed halfword, sign extends to 32 bits (LDR only)
 - : Omit, for word
- ‘*cond*’ is an optional condition code (see [Conditional execution on page 57](#))
- ‘*Rt*’ is the register to load or store
- ‘*Rn*’ is the register on which the memory address is based
- ‘*offset*’ is an offset from *Rn*. If *offset* is omitted, the address is the contents of *Rn*
- ‘*Rt2*’ is the additional register to load or store for two-word operations

Operation

LDR instructions load one or two registers with a value from memory. STR instructions store one or two register values to memory.

Load and store instructions with immediate offset can use the following addressing modes:

- **Offset addressing**
The offset value is added to or subtracted from the address obtained from the register *Rn*. The result is used as the address for the memory access. The register *Rn* is unaltered. The assembly language syntax for this mode is: [*Rn*, #*offset*].
- **Pre-indexed addressing**
The offset value is added to or subtracted from the address obtained from the register *Rn*. The result is used as the address for the memory access and written back into the register *Rn*. The assembly language syntax for this mode is: [*Rn*, #*offset*]!
- **Post-indexed addressing**
The address obtained from the register *Rn* is used as the address for the memory access. The offset value is added to or subtracted from the address, and written back into the register *Rn*. The assembly language syntax for this mode is: [*Rn*], #*offset*.

The value to load or store can be a byte, halfword, word, or two words. Bytes and halfwords can either be signed or unsigned (see [Address alignment on page 56](#)).

[Table 25](#) shows the range of offsets for immediate, pre-indexed and post-indexed forms.

Table 25. Immediate, pre-indexed and post-indexed offset ranges

Instruction type	Immediate offset	Pre-indexed	Post-indexed
Word, halfword, signed halfword, byte, or signed byte	-255 to 4095	-255 to 255	-255 to 255
Two words	Multiple of 4 in the range -1020 to 1020	Multiple of 4 in the range -1020 to 1020	Multiple of 4 in the range -1020 to 1020

Restrictions

- For load instructions
 - *Rt* can be SP or PC for word loads only
 - *Rt* must be different from *Rt2* for two-word loads
 - *Rn* must be different from *Rt* and *Rt2* in the pre-indexed or post-indexed forms
- When *Rt* is PC in a word load instruction
 - bit[0] of the loaded value must be 1 for correct execution
 - A branch occurs to the address created by changing bit[0] of the loaded value to 0
 - If the instruction is conditional, it must be the last instruction in the IT block
- For store instructions
 - *Rt* can be SP for word stores only
 - *Rt* must not be PC
 - *Rn* must not be PC
 - *Rn* must be different from *Rt* and *Rt2* in the pre-indexed or post-indexed forms

Condition flags

These instructions do not change the flags.

Examples

```
LDRR8, [R10]; loads R8 from the address in R10.
LDRNER2, [R5, #960]!; loads (conditionally) R2 from a word
; 960 bytes above the address in R5, and
; increments R5 by 960.
STRR2, [R9, #const-struct]; const-struct is an expression evaluating
; to a constant in the range 0-4095.
STRHR3, [R4], #4; Store R3 as halfword data into address in
; R4, then increment R4 by 4
LDRD R8, R9, [R3, #0x20]; Load R8 from a word 32 bytes above the
; address in R3, and load R9 from a word 36
; bytes above the address in R3
STRDR0, R1, [R8], #-16; Store R0 to address in R8, and store R1 to
; a word 4 bytes above the address in R8,
; and then decrement R8 by 16.
```

3.4.3 LDR and STR, register offset

Load and store with register offset.

Syntax

```
op{type}{cond} Rt, [Rn, Rm {, LSL #n}]
```

where:

- ‘*op*’ is either LDR (load register) or STR (store register)
- ‘*type*’ is one of the following:
 - B: Unsigned byte, zero extends to 32 bits on loads
 - SB: Signed byte, sign extends to 32 bits (LDR only)
 - H: Unsigned halfword, zero extends to 32 bits on loads
 - SH: Signed halfword, sign extends to 32 bits (LDR only)
 - : Omit, for word
- ‘*cond*’ is an optional condition code (see [Conditional execution on page 57](#))
- ‘*Rt*’ is the register to load or store
- ‘*Rn*’ is the register on which the memory address is based
- ‘*Rm*’ is a register containing a value to be used as the offset
- ‘*LSL #n*’ is an optional shift, with *n* in the range 0 to 3

Operation

LDR instructions load a register with a value from memory. STR instructions store a register value into memory.

The memory address to load from or store to is at an offset from the register *Rn*. The offset is specified by the register *Rm* and can be shifted left by up to 3 bits using LSL.

The value to load or store can be a byte, halfword, or word. For load instructions, bytes and halfwords can either be signed or unsigned (see [Address alignment on page 56](#)).

Restrictions

In these instructions:

- *Rn* must not be PC
- *Rm* must be neither SP nor PC
- *Rt* can be SP only for word loads and word stores
- *Rt* can be PC only for word loads

When *Rt* is PC in a word load instruction:

- bit[0] of the loaded value must be 1 for correct execution, and a branch occurs to this halfword-aligned address
- If the instruction is conditional, it must be the last instruction in the IT block.

Condition flags

These instructions do not change the flags.

Examples

```
STRR0, [R5, R1]; store value of R0 into an address equal to
; sum of R5 and R1
LDRSBR0, [R5, R1, LSL #1]; read byte value from an address equal to
; sum of R5 and two times R1, sign extended it
; to a word value and put it in R0
STRR0, [R1, R2, LSL #2]; stores R0 to an address equal to sum of R1
; and four times R2
```

3.4.4 LDR and STR, unprivileged

Load and store with unprivileged access.

Syntax

```
op{type}T{cond} Rt, [Rn {, #offset}]; immediate offset
```

where:

- '*op*' is either LDR (load register) or STR (store register)
- '*type*' is one of the following:
 - B: Unsigned byte, zero extends to 32 bits on loads
 - SB: Signed byte, sign extends to 32 bits (LDR only)
 - H: Unsigned halfword, zero extends to 32 bits on loads
 - SH: Signed halfword, sign extends to 32 bits (LDR only)
 - : Omit, for word
- '*cond*' is an optional condition code (see [Conditional execution on page 57](#))
- '*Rt*' is the register to load or store
- '*Rn*' is the register on which the memory address is based
- '*offset*' is an offset from *Rn* and can be 0 to 255. If *offset* is omitted, the address is the value in *Rn*.

Operation

These load and store instructions perform the same function as the memory access instructions with immediate offset (see [LDR and STR, immediate offset on page 61](#)). The difference is that these instructions have only unprivileged access even when used in privileged software.

When used in unprivileged software, these instructions behave in exactly the same way as normal memory access instructions with immediate offset.

Restrictions

In these instructions:

- *Rn* must not be PC
- *Rt* must be neither SP nor PC.

Condition flags

These instructions do not change the flags.

Examples

```
STRBTEQR4, [R7]; conditionally store least significant byte in
; R4 to an address in R7, with unprivileged access
LDRHTR2, [R2, #8]; load halfword value from an address equal to
; sum of R2 and 8 into R2, with unprivileged access
```

3.4.5 LDR, PC-relative

Load register from memory.

Syntax

```
LDR{type}{cond} Rt, label
LDRD{cond} Rt, Rt2, label; load two words
```

where:

- '*type*' is one of the following:
 - B: Unsigned byte, zero extends to 32 bits
 - SB: Signed byte, sign extends to 32 bits
 - H: Unsigned halfword, sign extends to 32 bits
 - SH: Signed halfword, sign extends to 32 bits
 - : Omit, for word
- '*cond*' is an optional condition code (see [Conditional execution on page 57](#))
- '*Rt*' is the register to load or store
- '*Rt2*' is the second register to load or store
- '*label*' is a PC-relative expression (see [PC-relative expressions on page 56](#))

Operation

LDR loads a register with a value from a PC-relative memory address. The memory address is specified by a label or by an offset from the PC.

The value to load or store can be a byte, halfword, or word. For load instructions, bytes and halfwords can either be signed or unsigned (see [Address alignment on page 56](#)).

'label' must be within a limited range of the current instruction. [Table 26](#) shows the possible offsets between *label* and the PC.

Table 26. *label*-PC offset ranges

Instruction type	Offset range
Word, halfword, signed halfword, byte, signed byte	–4095 to 4095
Two words	–1020 to 1020

You might have to use the *.W* suffix to get the maximum offset range (see [Instruction width selection on page 59](#)).

Restrictions

In these instructions:

- *Rt* can be SP or PC only for word loads
- *Rt2* must be neither SP nor PC
- *Rt* must be different from *Rt2*

When *Rt* is PC in a word load instruction:

- bit[0] of the loaded value must be 1 for correct execution, and a branch occurs to this halfword-aligned address
- If the instruction is conditional, it must be the last instruction in the IT block.

Condition flags

These instructions do not change the flags.

Examples

```
LDRR0, LookUpTable; load R0 with a word of data from an address
; labelled as LookUpTable
LDRSBR7, localdata; load a byte value from an address labelled
; as localdata, sign extend it to a word
; value, and put it in R7
```

3.4.6 LDM and STM

Load and store multiple registers.

Syntax

```
op{addr_mode}{cond} Rn{!}, reglist
```

where:

- ‘*op*’ is either LDM (load multiple register) or STM (store multiple register)
- ‘*addr_mode*’ is any of the following:
 - IA: Increment address after each access (this is the default)
 - DB: Decrement address before each access
- ‘*cond*’ is an optional condition code (see [Conditional execution on page 57](#))
- ‘*Rn*’ is the register on which the memory addresses are based
- ‘!’ is an optional writeback suffix. If ‘!’ is present, the final address that is loaded from or stored to is written back into *Rn*.
- ‘*reglist*’ is a list of one or more registers to be loaded or stored, enclosed in braces. It can contain register ranges. It must be comma-separated if it contains more than one register or register range (see [Examples on page 68](#)).

LDM and LDMFD are synonyms for LDMIA. LDMFD refers to its use for popping data from full descending stacks.

LDMEA is a synonym for LDMDB, and refers to its use for popping data from empty ascending stacks.

STM and STMEA are synonyms for STMIA. STMEA refers to its use for pushing data onto empty ascending stacks.

STMFD is a synonym for STMDB, and refers to its use for pushing data onto full descending stacks

Operation

LDM instructions load the registers in *reglist* with word values from memory addresses based on *Rn*.

STM instructions store the word values in the registers in *reglist* to memory addresses based on *Rn*.

For LDM, LDMIA, LDMFD, STM, STMIA, and STMEA the memory addresses used for the accesses are at 4-byte intervals ranging from Rn to $Rn + 4 * (n-1)$, where n is the number of registers in *reglist*. The accesses happen in order of increasing register numbers, with the lowest numbered register using the lowest memory address and the highest number register using the highest memory address. If the writeback suffix is specified, the value of $Rn + 4 * (n-1)$ is written back to *Rn*.

For LDMDB, LDMEA, STMDB, and STMFD the memory addresses used for the accesses are at 4-byte intervals ranging from Rn to $Rn - 4 * (n-1)$, where n is the number of registers in *reglist*. The accesses happen in order of decreasing register numbers, with the highest numbered register using the highest memory address and the lowest number register using the lowest memory address. If the writeback suffix is specified, the value $Rn - 4 * (n-1)$ is written back to *Rn*.

The PUSH and POP instructions can be expressed in this form (see [PUSH and POP](#) for details).

Restrictions

In these instructions:

- *Rn* must not be PC
- *reglist* must not contain SP
- In any STM instruction, *reglist* must not contain PC
- In any LDM instruction, *reglist* must not contain PC if it contains LR
- *reglist* must not contain *Rn* if you specify the writeback suffix

When PC is in *reglist* in an LDM instruction:

- bit[0] of the value loaded to the PC must be 1 for correct execution, and a branch occurs to this halfword-aligned address.
- If the instruction is conditional, it must be the last instruction in the IT block

Condition flags

These instructions do not change the flags.

Examples

```
LDMR8, {R0, R2, R9}; LDMIA is a synonym for LDM
STMDBR1!, {R3-R6, R11, R12}
```

Incorrect examples

```
STM5!, {R5, R4, R9}; value stored for R5 is unpredictable
LDMR2, {}; there must be at least one register in the list
```

3.4.7 PUSH and POP

Push registers onto, and pop registers off a full-descending stack.

Syntax

```
PUSH{cond} reglist
```

```
POP{cond} reglist
```

where:

- '*cond*' is an optional condition code (see [Conditional execution on page 57](#))
- '*reglist*' is a non-empty list of registers, enclosed in braces. It can contain register ranges. It must be comma-separated if it contains more than one register or register range (see [Examples on page 68](#)).

PUSH and POP are synonyms for STMDB and LDM (or LDMIA) with the memory addresses for the access based on SP, and with the final address for the access written back to the SP. PUSH and POP are the preferred mnemonics in these cases.

Operation

PUSH stores registers on the stack in order of decreasing register numbers, with the highest numbered register using the highest memory address and the lowest numbered register using the lowest memory address.

POP loads registers from the stack in order of increasing register numbers, with the lowest numbered register using the lowest memory address and the highest numbered register using the highest memory address.

See [LDM and STM on page 67](#) for more information.

Restrictions

In these instructions:

- *'reglist'* must not contain SP
- For the PUSH instruction, *reglist* must not contain PC
- For the POP instruction, *reglist* must not contain PC if it contains LR

When PC is in *reglist* in a POP instruction:

- bit[0] of the value loaded to the PC must be 1 for correct execution, and a branch occurs to this halfword-aligned address.
- If the instruction is conditional, it must be the last instruction in the IT block.

Condition flags

These instructions do not change the flags.

Examples

```
PUSH{R0, R4-R7}
PUSH{R2, LR}
POP{R0, R10, PC}
```

3.4.8 LDREX and STREX

Load and store register exclusive.

Syntax

```
LDREX{cond} Rt, [Rn {, #offset}]
```

```
STREX{cond} Rd, Rt, [Rn {, #offset}]
```

```
LDREXB{cond} Rt, [Rn]
```

```
STREXB{cond} Rd, Rt, [Rn]
```

```
LDREXH{cond} Rt, [Rn]
```

```
STREXH{cond} Rd, Rt, [Rn]
```

where:

- ‘*cond*’ is an optional condition code (see [Conditional execution on page 57](#))
- ‘*Rd*’ is the destination register for the returned status
- ‘*Rt*’ is the register to load or store
- ‘*Rn*’ is the register on which the memory address is based
- ‘*offset*’ is an optional offset applied to the value in *Rn*. If *offset* is omitted, the address is the value in *Rn*.

Operation

LDREX, LDREXB, and LDREXH load a word, byte, and halfword respectively from a memory address.

STREX, STREXB, and STREXH attempt to store a word, byte, and halfword respectively to a memory address. The address used in any store-exclusive instruction must be the same as the address in the most recently executed load-exclusive instruction. The value stored by the Store-exclusive instruction must also have the same data size as the value loaded by the preceding load-exclusive instruction. This means software must always use a load-exclusive instruction and a matching store-exclusive instruction to perform a synchronization operation, see [Synchronization primitives on page 31](#).

If a store-exclusive instruction performs the store, it writes 0 to its destination register. If it does not perform the store, it writes 1 to its destination register. If the store-exclusive instruction writes 0 to the destination register, it is guaranteed that no other process in the system has accessed the memory location between the load-exclusive and store-exclusive instructions.

For reasons of performance, keep the number of instructions between corresponding load-exclusive and store-exclusive instruction to a minimum.

Note: *The result of executing a store-exclusive instruction to an address that is different from that used in the preceding load-exclusive instruction is unpredictable.*

Restrictions

In these instructions:

- Do not use PC
- Do not use SP for *Rd* and *Rt*
- For STREX, *Rd* must be different from both *Rt* and *Rn*
- The value of offset must be a multiple of four in the range 0-1020

Condition flags

These instructions do not change the flags.

Examples

```

MOVRL, #0x1; initialize the 'lock taken' value
LDREXR0, [LockAddr]; load the lock value
CMPR0, #0; is the lock free?
ITTEQ; IT instruction for STREXEQ and CMPEQ
STREXEQR0, R1, [LockAddr]; try and claim the lock
CMPEQR0, #0; did this succeed?
BNETry; no - try again
; yes - we have the lock

```

3.4.9 CLREX

Clear exclusive.

Syntax

```
CLREX{cond}
```

where:

'*cond*' is an optional condition code (see [Conditional execution on page 57](#))

Operation

Use CLREX to make the next STREX, STREXB, or STREXH instruction write 1 to its destination register and fail to perform the store. It is useful in exception handler code to force the failure of the store exclusive if the exception occurs between a load exclusive instruction and the matching store exclusive instruction in a synchronization operation.

See [Synchronization primitives on page 31](#) for more information.

Condition flags

These instructions do not change the flags.

Examples

```
CLREX
```

3.5 General data processing instructions

Table 27 shows the data processing instructions.

Table 27. Data processing instructions

Mnemonic	Brief description	See
ADC	Add with carry	<i>ADD, ADC, SUB, SBC, and RSB on page 73</i>
ADD	Add	<i>ADD, ADC, SUB, SBC, and RSB on page 73</i>
ADDW	Add	<i>ADD, ADC, SUB, SBC, and RSB on page 73</i>
AND	Logical AND	<i>AND, ORR, EOR, BIC, and ORN on page 75</i>
ASR	Arithmetic shift right	<i>ASR, LSL, LSR, ROR, and RRX on page 76</i>
BIC	Bit clear	<i>AND, ORR, EOR, BIC, and ORN on page 75</i>
CLZ	Count leading zeros	<i>CLZ on page 77</i>
CMN	Compare negative	<i>CMP and CMN on page 78</i>
CMP	Compare	<i>CMP and CMN on page 78</i>
EOR	Exclusive OR	<i>AND, ORR, EOR, BIC, and ORN on page 75</i>
LSL	Logical shift left	<i>ASR, LSL, LSR, ROR, and RRX on page 76</i>
LSR	Logical shift right	<i>ASR, LSL, LSR, ROR, and RRX on page 76</i>
MOV	Move	<i>MOV and MVN on page 79</i>
MOVT	Move top	<i>MOVT on page 80</i>
MOVW	Move 16-bit constant	<i>MOV and MVN on page 79</i>
MVN	Move NOT	<i>MOV and MVN on page 79</i>
ORN	Logical OR NOT	<i>AND, ORR, EOR, BIC, and ORN on page 75</i>
ORR	Logical OR	<i>AND, ORR, EOR, BIC, and ORN on page 75</i>
RBIT	Reverse bits	<i>REV, REV16, REVSH, and RBIT on page 81</i>
REV	Reverse byte order in a word	<i>REV, REV16, REVSH, and RBIT on page 81</i>
REV16	Reverse byte order in each halfword	<i>REV, REV16, REVSH, and RBIT on page 81</i>
REVSH	Reverse byte order in bottom halfword and sign extend	<i>REV, REV16, REVSH, and RBIT on page 81</i>
ROR	Rotate right	<i>ASR, LSL, LSR, ROR, and RRX on page 76</i>
RRX	Rotate right with extend	<i>ASR, LSL, LSR, ROR, and RRX on page 76</i>
RSB	Reverse subtract	<i>ADD, ADC, SUB, SBC, and RSB on page 73</i>
SBC	Subtract with carry	<i>ADD, ADC, SUB, SBC, and RSB on page 73</i>
SUB	Subtract	<i>ADD, ADC, SUB, SBC, and RSB on page 73</i>
SUBW	Subtract	<i>ADD, ADC, SUB, SBC, and RSB on page 73</i>
TEQ	Test equivalence	<i>TST and TEQ on page 82</i>
TST	Test	<i>TST and TEQ on page 82</i>

3.5.1 ADD, ADC, SUB, SBC, and RSB

Add, add with carry, subtract, subtract with carry, and reverse subtract.

Syntax

```
op{S}{cond} {Rd,} Rn, Operand2
```

```
op{cond} {Rd,} Rn, #imm12; ADD and SUB only
```

where:

- ‘*op*’ is one of:
 ADD: Add
 ADC: Add with carry
 SUB: Subtract
 SBC: Subtract with carry
 RSB: Reverse subtract
- ‘*S*’ is an optional suffix. If *S* is specified, the condition code flags are updated on the result of the operation (see [Conditional execution on page 57](#))
- ‘*cond*’ is an optional condition code (see [Conditional execution on page 57](#))
- ‘*Rd*’ is the destination register. If *Rd* is omitted, the destination register is *Rn*
- ‘*Rn*’ is the register holding the first operand
- ‘*Operand2*’ is a flexible second operand (see [Flexible second operand on page 52](#) for details of the options).
- ‘*imm12*’ is any value in the range 0—4095

Operation

The ADD instruction adds the value of *operand2* or *imm12* to the value in *Rn*.

The ADC instruction adds the values in *Rn* and *operand2*, together with the carry flag.

The SUB instruction subtracts the value of *operand2* or *imm12* from the value in *Rn*.

The SBC instruction subtracts the value of *operand2* from the value in *Rn*. If the carry flag is clear, the result is reduced by one.

The RSB instruction subtracts the value in *Rn* from the value of *operand2*. This is useful because of the wide range of options for *operand2*.

Use ADC and SBC to synthesize multiword arithmetic (see [Multiword arithmetic examples on page 74](#) and [ADR on page 60](#)).

ADDW is equivalent to the ADD syntax that uses the *imm12* operand. SUBW is equivalent to the SUB syntax that uses the *imm12* operand.

Restrictions

In these instructions:

- *Operand2* must be neither SP nor PC
- *Rd* can be SP only in ADD and SUB, and only with the following additional restrictions:
 - *Rn* must also be SP
 - Any shift in operand2 must be limited to a maximum of three bits using LSL
- *Rn* can be SP only in ADD and SUB
- *Rd* can be PC only in the ADD{cond} PC, PC, *Rm* instruction where:
 - You must not specify the S suffix
 - *Rm* must be neither PC nor SP
 - If the instruction is conditional, it must be the last instruction in the IT block
- With the exception of the ADD{cond} PC, PC, *Rm* instruction, *Rn* can be PC only in ADD and SUB, and only with the following additional restrictions:
 - You must not specify the S suffix
 - The second operand must be a constant in the range 0 to 4095

- Note:*
- 1 When using the PC for an addition or a subtraction, bits[1:0] of the PC are rounded to b00 before performing the calculation, making the base address for the calculation word-aligned.
 - 2 If you want to generate the address of an instruction, you have to adjust the constant based on the value of the PC. ARM recommends that you use the ADR instruction instead of ADD or SUB with *Rn* equal to the PC, because your assembler automatically calculates the correct constant for the ADR instruction.

When *Rd* is PC in the ADD{cond} PC, PC, *Rm* instruction:

- bit[0] of the value written to the PC is ignored
- A branch occurs to the address created by forcing bit[0] of that value to 0

Condition flags

If S is specified, these instructions update the N, Z, C and V flags according to the result.

Examples

```
ADDR2, R1, R3
SUBSR8, R6, #240; sets the flags on the result
RSBR4, R4, #1280; subtracts contents of R4 from 1280
ADCHIR11, R0, R3; only executed if C flag set and Z
; flag clear
```

Multyword arithmetic examples

[Specific example 4: 64-bit addition](#) shows two instructions that add a 64-bit integer contained in R2 and R3 to another 64-bit integer contained in R0 and R1, and place the result in R4 and R5.

Specific example 4: 64-bit addition

```
ADDSR4, R0, R2; add the least significant words
ADCR5, R1, R3; add the most significant words with carry
```

Multiword values do not have to use consecutive registers. [Specific example 5: 96-bit subtraction](#) shows instructions that subtract a 96-bit integer contained in R9, R1, and R11 from another contained in R6, R2, and R8. The example stores the result in R6, R9, and R2.

Specific example 5: 96-bit subtraction

```
SUBSR6, R6, R9; subtract the least significant words
SBCSR9, R2, R1; subtract the middle words with carry
SBCR2, R8, R11; subtract the most significant words with carry
```

3.5.2 AND, ORR, EOR, BIC, and ORN

Logical AND, OR, exclusive OR, bit clear, and OR NOT.

Syntax

```
op{S}{cond} {Rd,} Rn, Operand2
```

where:

- ‘*op*’ is one of:
AND: Logical AND
ORR: Logical OR or bit set
EOR: Logical exclusive OR
BIC: Logical AND NOT or bit clear
ORN: Logical OR NOT
- ‘*S*’ is an optional suffix. If *S* is specified, the condition code flags are updated on the result of the operation (see [Conditional execution on page 57](#)).
- ‘*cond*’ is an optional condition code (see [Conditional execution on page 57](#))
- ‘*Rd*’ is the destination register
- ‘*Rn*’ is the register holding the first operand
- ‘*Operand2*’ is a flexible second operand (see [Flexible second operand on page 52](#) for details of the options).

Operation

The AND, EOR, and ORR instructions perform bitwise AND, exclusive OR, and OR operations on the values in *Rn* and *operand2*.

The BIC instruction performs an AND operation on the bits in *Rn* with the complements of the corresponding bits in the value of *operand2*.

The ORN instruction performs an OR operation on the bits in *Rn* with the complements of the corresponding bits in the value of *operand2*.

Restrictions

Do not use either SP or PC.

Condition flags

If S is specified, these instructions:

- Update the N and Z flags according to the result
- Can update the C flag during the calculation of *operand2* (see [Flexible second operand on page 52](#))
- Do not affect the V flag

Examples

```
ANDR9, R2, #0xFF00
ORREQR2, R0, R5
ANDSR9, R8, #0x19
EORSR7, R11, #0x18181818
BICR0, R1, #0xab
ORNR7, R11, R14, ROR #4
ORNSR7, R11, R14, ASR #32
```

3.5.3 ASR, LSL, LSR, ROR, and RRX

Arithmetic shift right, logical shift left, logical shift right, rotate right, and rotate right with extend.

Syntax

```
op{S}{cond} Rd, Rm, Rs
op{S}{cond} Rd, Rm, #n
RRX{S}{cond} Rd, Rm
```

where:

- ‘*op*’ is one of:
 - ASR: Arithmetic shift right
 - LSL: Logical shift left
 - LSR: Logical shift right
 - ROR: Rotate right
- ‘S’ is an optional suffix. If S is specified, the condition code flags are updated on the result of the operation (see [Conditional execution on page 57](#))
- ‘*Rd*’ is the destination register
- ‘*Rm*’ is the register holding the value to be shifted
- ‘*Rs*’ is the register holding the shift length to apply to the value *Rm*. Only the least significant byte is used and can be in the range 0 to 255.
- ‘*n*’ is the shift length. The range of shift lengths depend on the instruction as follows:
 - ASR: Shift length from 1 to 32
 - LSL: Shift length from 0 to 31
 - LSR: Shift length from 1 to 32
 - ROR: Shift length from 1 to 31

Note: `MOV{S}{cond} Rd, Rm` is the preferred syntax for `LSL{S}{cond} Rd, Rm, #0`.

Operation

ASR, LSL, LSR, and ROR move the bits in the register *Rm* to the left or right by the number of places specified by constant *n* or register *Rs*.

RRX moves the bits in register *Rm* to the right by 1.

In all these instructions, the result is written to *Rd*, but the value in register *Rm* remains unchanged. For details on what result is generated by the different instructions (see [Shift operations on page 53](#)).

Restrictions

Do not use either SP or PC.

Condition flags

If S is specified:

- These instructions update the N and Z flags according to the result
- The C flag is updated to the last bit shifted out, except when the shift length is 0 (see [Shift operations on page 53](#)).

Examples

```
ASRR7, R8, #9; arithmetic shift right by 9 bits
LSLSR1, R2, #3; logical shift left by 3 bits with flag update
LSRR4, R5, #6; logical shift right by 6 bits
RORR4, R5, R6; rotate right by the value in the bottom byte of R6
RRXR4, R5; rotate right with extend
```

3.5.4 CLZ

Count leading zeros.

Syntax

```
CLZ{cond} Rd, Rm
```

where:

- '*cond*' is an optional condition code (see [Conditional execution on page 57](#))
- '*Rd*' is the destination register
- '*Rm*' is the operand register

Operation

The CLZ instruction counts the number of leading zeros in the value in *Rm* and returns the result in *Rd*. The result value is 32 if no bits are set in the source register, and zero if bit[31] is set.

Restrictions

Do not use either SP or PC.

Condition flags

This instruction does not change the flags.

Examples

```
CLZR4, R9
CLZNER2, R3
```

3.5.5 CMP and CMN

Compare and compare negative.

Syntax

```
CMP{cond} Rn, Operand2
CMN{cond} Rn, Operand2
```

where:

- ‘*cond*’ is an optional condition code (see [Conditional execution on page 57](#))
- ‘*Rn*’ is the register holding the first operand
- ‘*Operand2*’ is a flexible second operand (see [Flexible second operand on page 52](#)) for details of the options.

Operation

These instructions compare the value in a register with *operand2*. They update the condition flags on the result, but do not write the result to a register.

The CMP instruction subtracts the value of *operand2* from the value in *Rn*. This is the same as a SUBS instruction, except that the result is discarded.

The CMN instruction adds the value of *operand2* to the value in *Rn*. This is the same as an ADDS instruction, except that the result is discarded.

Restrictions

In these instructions:

- Do not use PC
- *Operand2* must not be SP

Condition flags

These instructions update the N, Z, C and V flags according to the result.

Examples

```
CMPR2, R9
CMNR0, #6400
CMPGTSP, R7, LSL #2
```

3.5.6 MOV and MVN

Move and move NOT.

Syntax

MOV{S}{cond} Rd, Operand2

MOV{cond} Rd, #imm16

MVN{S}{cond} Rd, Operand2

where:

- 'S' is an optional suffix. If S is specified, the condition code flags are updated on the result of the operation (see [Conditional execution on page 57](#)).
- 'cond' is an optional condition code (see [Conditional execution on page 57](#))
- 'Rd' is the destination register
- 'Operand2' is a flexible second operand (see [Flexible second operand on page 52](#)) for details of the options.
- 'imm16' is any value in the range 0—65535

Operation

The MOV instruction copies the value of *operand2* into *Rd*.

When *operand2* in a MOV instruction is a register with a shift other than LSL #0, the preferred syntax is the corresponding shift instruction:

- ASR{S}{cond} Rd, Rm, #n is the preferred syntax for MOV{S}{cond} Rd, Rm, ASR #n
- LSL{S}{cond} Rd, Rm, #n is the preferred syntax for MOV{S}{cond} Rd, Rm, LSL #n if n != 0
- LSR{S}{cond} Rd, Rm, #n is the preferred syntax for MOV{S}{cond} Rd, Rm, LSR #n
- ROR{S}{cond} Rd, Rm, #n is the preferred syntax for MOV{S}{cond} Rd, Rm, ROR #n
- RRX{S}{cond} Rd, Rm is the preferred syntax for MOV{S}{cond} Rd, Rm, RRX

Also, the MOV instruction permits additional forms of *operand2* as synonyms for shift instructions:

- MOV{S}{cond} Rd, Rm, ASR Rs is a synonym for ASR{S}{cond} Rd, Rm, Rs
- MOV{S}{cond} Rd, Rm, LSL Rs is a synonym for LSL{S}{cond} Rd, Rm, Rs
- MOV{S}{cond} Rd, Rm, LSR Rs is a synonym for LSR{S}{cond} Rd, Rm, Rs
- MOV{S}{cond} Rd, Rm, ROR Rs is a synonym for ROR{S}{cond} Rd, Rm, Rs

See [ASR, LSL, LSR, ROR, and RRX on page 76](#).

The MVN instruction takes the value of *operand2*, performs a bitwise logical NOT operation on the value, and places the result into *Rd*.

Note: *The MOVW instruction provides the same function as MOV, but is restricted to using the imm16 operand.*

Restrictions

You can use SP and PC only in the MOV instruction, with the following restrictions:

- The second operand must be a register without shift
- You must not specify the S suffix

When *Rd* is PC in a MOV instruction:

- bit[0] of the value written to the PC is ignored
- A branch occurs to the address created by forcing bit[0] of that value to 0.

Note: Though it is possible to use MOV as a branch instruction, ARM strongly recommends the use of a BX or BLX instruction to branch for software portability to the ARM instruction set.

Condition flags

If S is specified, these instructions:

- Update the N and Z flags according to the result
- Can update the C flag during the calculation of *operand2* (see [Flexible second operand on page 52](#)).
- Do not affect the V flag

Example

```
MOVSR11, #0x000B; write value of 0x000B to R11, flags get updated
MOVR1, #0xFA05; write value of 0xFA05 to R1, flags are not updated
MOVSR10, R12; write value in R12 to R10, flags get updated
MOVR3, #23; write value of 23 to R3
MOVR8, SP; write value of stack pointer to R8
MVNSR2, #0xF; write value of 0xFFFFFFFF0 (bitwise inverse of 0xF)
; to the R2 and update flags
```

3.5.7 MOVT

Move top.

Syntax

```
MOVT{cond} Rd, #imm16
```

where:

- '*cond*' is an optional condition code (see [Conditional execution on page 57](#))
- '*Rd*' is the destination register
- '*imm16*' is a 16-bit immediate constant

Operation

MOVT writes a 16-bit immediate value, *imm16*, to the top halfword, *Rd*[31:16], of its destination register. The write does not affect *Rd*[15:0].

The MOV, MOVT instruction pair enables you to generate any 32-bit constant.

Restrictions

Rd must be neither SP nor PC.

Condition flags

This instruction does not change the flags.

Examples

```
MOVTR3, #0xF123; write 0xF123 to upper halfword of R3, lower halfword
; and APSR are unchanged
```

3.5.8 REV, REV16, REVSH, and RBIT

Reverse bytes and reverse bits.

Syntax

```
op{cond} Rd, Rn
```

where:

- ‘*op*’ is one of:
 - REV: Reverse byte order in a word
 - REV16: Reverse byte order in each halfword independently
 - REVSH: Reverse byte order in the bottom halfword, and sign extends to 32 bits
 - RBIT: Reverse the bit order in a 32-bit word
- ‘*cond*’ is an optional condition code (see [Conditional execution on page 57](#))
- ‘*Rd*’ is the destination register
- ‘*Rn*’ is the register holding the operand

Operation

Use these instructions to change endianness of data:

- REV: Converts 32-bit big-endian data into little-endian data or 32-bit little-endian data into big-endian data.
- REV16: Converts 16-bit big-endian data into little-endian data or 16-bit little-endian data into big-endian data.
- REVSH: Converts either:
 - 16-bit signed big-endian data into 32-bit signed little-endian data
 - 16-bit signed little-endian data into 32-bit signed big-endian data

Restrictions

Do not use either SP or PC.

Condition flags

These instructions do not change the flags.

Examples

```
REVR3, R7; reverse byte order of value in R7 and write it to R3
REV16 R0, R0; reverse byte order of each 16-bit halfword in R0
```

```

REVSH R0, R5 ; reverse Signed Halfword
REVHS R3, R7 ; reverse with Higher or Same condition
RBIT R7, R8 ; reverse bit order of value in R8 and write the result to R7

```

3.5.9 TST and TEQ

Test bits and test equivalence.

Syntax

```
TST{cond} Rn, Operand2
```

```
TEQ{cond} Rn, Operand2
```

where:

- ‘*cond*’ is an optional condition code (see [Conditional execution on page 57](#))
- ‘*Rn*’ is the register holding the first operand
- ‘*Operand2*’ is a flexible second operand (see [Flexible second operand on page 52](#)) for details of the options.

Operation

These instructions test the value in a register against *operand2*. They update the condition flags based on the result, but do not write the result to a register.

The TST instruction performs a bitwise AND operation on the value in *Rn* and the value of *operand2*. This is the same as the ANDS instruction, except that it discards the result.

To test whether a bit of *Rn* is 0 or 1, use the TST instruction with an *operand2* constant that has that bit set to 1 and all other bits cleared to 0.

The TEQ instruction performs a bitwise exclusive OR operation on the value in *Rn* and the value of *operand2*. This is the same as the EORS instruction, except that it discards the result.

Use the TEQ instruction to test if two values are equal without affecting the V or C flags.

TEQ is also useful for testing the sign of a value. After the comparison, the N flag is the logical exclusive OR of the sign bits of the two operands.

Restrictions

Do not use either SP or PC.

Condition flags

These instructions:

- Update the N and Z flags according to the result
- Can update the C flag during the calculation of *operand2* (see [Flexible second operand on page 52](#)).
- Do not affect the V flag

Examples

```

TSTR0, #0x3F8; perform bitwise AND of R0 value to 0x3F8,
; APSR is updated but result is discarded
TEQEQR10, R9; conditionally test if value in R10 is equal to
; value in R9, APSR is updated but result is discarded

```

3.6 Multiply and divide instructions

[Table 28](#) shows the multiply and divide instructions.

Table 28. Multiply and divide instructions

Mnemonic	Brief description	See
MLA	Multiply with accumulate, 32-bit result	MUL, MLA, and MLS on page 83
MLS	Multiply and subtract, 32-bit result	MUL, MLA, and MLS on page 83
MUL	Multiply, 32-bit result	MUL, MLA, and MLS on page 83
SDIV	Signed divide	SDIV and UDIV on page 86
SMLAL	Signed multiply with accumulate (32x32+64), 64-bit result	UMULL, UMLAL, SMULL, and SMLAL on page 85
SMULL	Signed multiply (32x32), 64-bit result	UMULL, UMLAL, SMULL, and SMLAL on page 85
UDIV	Unsigned divide	SDIV and UDIV on page 86
UMLAL	Unsigned multiply with accumulate (32x32+64), 64-bit result	UMULL, UMLAL, SMULL, and SMLAL on page 85
UMULL	Unsigned multiply (32x32), 64-bit result	UMULL, UMLAL, SMULL, and SMLAL on page 85

3.6.1 MUL, MLA, and MLS

Multiply, multiply with accumulate, and multiply with subtract, using 32-bit operands, and producing a 32-bit result.

Syntax

```
MUL{S}{cond} {Rd,} Rn, Rm ; Multiply
```

```
MLA{cond} Rd, Rn, Rm, Ra ; Multiply with accumulate
```

```
MLS{cond} Rd, Rn, Rm, Ra ; Multiply with subtract
```

where:

- ‘*cond*’ is an optional condition code (see [Conditional execution on page 57](#))
- ‘*S*’ is an optional suffix. If *S* is specified, the condition code flags are updated on the result of the operation (see [Conditional execution on page 57](#)).
- ‘*Rd*’ is the destination register. If *Rd* is omitted, the destination register is *Rn*
- ‘*Rn*’, ‘*Rm*’ are registers holding the values to be multiplied
- ‘*Ra*’ is a register holding the value to be added to or subtracted from

Operation

The MUL instruction multiplies the values from *Rn* and *Rm*, and places the least significant 32 bits of the result in *Rd*.

The MLA instruction multiplies the values from *Rn* and *Rm*, adds the value from *Ra*, and places the least significant 32 bits of the result in *Rd*.

The MLS instruction multiplies the values from *Rn* and *Rm*, subtracts the product from the value from *Ra*, and places the least significant 32 bits of the result in *Rd*.

The results of these instructions do not depend on whether the operands are signed or unsigned.

Restrictions

In these instructions, do not use SP and do not use PC.

If you use the S suffix with the MUL instruction:

- *Rd*, *Rn*, and *Rm* must all be in the range R0 to R7
- *Rd* must be the same as *Rm*
- You must not use the *cond* suffix

Condition flags

If S is specified, the MUL instruction:

- Updates the N and Z flags according to the result
- Does not affect the C and V flags

Examples

```
MULR10, R2, R5; multiply, R10 = R2 x R5
MLAR10, R2, R1, R5; multiply with accumulate, R10 = (R2 x R1) + R5
MULSR0, R2, R2; multiply with flag update, R0 = R2 x R2
MULLTR2, R3, R2; conditionally multiply, R2 = R3 x R2
MLSR4, R5, R6, R7; multiply with subtract, R4 = R7 - (R5 x R6)
```

3.6.2 UMULL, UMLAL, SMULL, and SMLAL

Signed and unsigned long multiply, with optional accumulate, using 32-bit operands and producing a 64-bit result.

Syntax

```
op{cond} RdLo, RdHi, Rn, Rm
```

where:

- 'op' is one of:
 - UMULL: Unsigned long multiply
 - UMLAL: Unsigned long multiply, with accumulate
 - SMULL: Signed long multiply
 - SMLAL: Signed long multiply, with accumulate
- 'cond' is an optional condition code (see [Conditional execution on page 57](#))
- 'RdHi, RdLo' are the destination registers. For UMLAL and SMLAL, they also hold the accumulating value.
- 'Rn, Rm' are registers holding the operands

Operation

The UMULL instruction interprets the values from *Rn* and *Rm* as unsigned integers. It multiplies these integers and places the least significant 32 bits of the result in *RdLo*, and the most significant 32 bits of the result in *RdHi*.

The UMLAL instruction interprets the values from *Rn* and *Rm* as unsigned integers. It multiplies these integers, adds the 64-bit result to the 64-bit unsigned integer contained in *RdHi* and *RdLo*, and writes the result back to *RdHi* and *RdLo*.

The SMULL instruction interprets the values from *Rn* and *Rm* as two's complement signed integers. It multiplies these integers and places the least significant 32 bits of the result in *RdLo*, and the most significant 32 bits of the result in *RdHi*.

The SMLAL instruction interprets the values from *Rn* and *Rm* as two's complement signed integers. It multiplies these integers, adds the 64-bit result to the 64-bit signed integer contained in *RdHi* and *RdLo*, and writes the result back to *RdHi* and *RdLo*.

Restrictions

In these instructions:

- Do not use either SP or PC
- *RdHi* and *RdLo* must be different registers

Condition flags

These instructions do not affect the condition code flags.

Examples

```
UMULLR0, R4, R5, R6; unsigned (R4,R0) = R5 x R6
SMLALR4, R5, R3, R8; signed (R5,R4) = (R5,R4) + R3 x R8
```

3.6.3 SDIV and UDIV

Signed divide and unsigned divide.

Syntax

```
SDIV{cond} {Rd,} Rn, Rm
```

```
UDIV{cond} {Rd,} Rn, Rm
```

where:

- ‘*cond*’ is an optional condition code (see [Conditional execution on page 57](#))
- ‘*Rd*’ is the destination register. If *Rd* is omitted, the destination register is *Rn*
- ‘*Rn*,’ is the register holding the value to be divided
- ‘*Rm*’ is a register holding the divisor

Operation

SDIV performs a signed integer division of the value in *Rn* by the value in *Rm*.

UDIV performs an unsigned integer division of the value in *Rn* by the value in *Rm*.

For both instructions, if the value in *Rn* is not divisible by the value in *Rm*, the result is rounded towards zero.

Restrictions

Do not use either SP or PC.

Condition flags

These instructions do not change the flags.

Examples

```
SDIVR0, R2, R4; signed divide, R0 = R2/R4  
UDIVR8, R8, R1; unsigned divide, R8 = R8/R1
```

3.7 Saturating instructions

This section describes the saturating instructions, SSAT and USAT.

3.7.1 SSAT and USAT

Signed saturate and unsigned saturate to any bit position, with optional shift before saturating.

Syntax

```
op{cond} Rd, #n, Rm {, shift #s}
```

where:

- ‘*op*’ is one of the following:
 - SSAT: Saturates a signed value to a signed range
 - USAT: Saturates a signed value to an unsigned range
- ‘*cond*’ is an optional condition code (see [Conditional execution on page 57](#))
- ‘*Rd*’ is the destination register.
- ‘*n*’ specifies the bit position to saturate to:
 - n* ranges from 1 to 32 for SSAT
 - n* ranges from 0 to 31 for USAT
- ‘*Rm*’ is the register containing the value to saturate
- ‘*shift #s*’ is an optional shift applied to *Rm* before saturating. It must be one of the following:
 - ASR #s where *s* is in the range 1 to 31
 - LSL #s where *s* is in the range 0 to 31

Operation

These instructions saturate to a signed or unsigned *n*-bit value.

The SSAT instruction applies the specified shift, then saturates to the signed range: $-2^{n-1} \leq x \leq 2^{n-1}-1$.

The USAT instruction applies the specified shift, then saturates to the unsigned range: $0 \leq x \leq 2^n-1$.

For signed *n*-bit saturation using SSAT, this means that:

- If the value to be saturated is less than -2^{n-1} , the result returned is -2^{n-1}
- If the value to be saturated is greater than $2^{n-1}-1$, the result returned is $2^{n-1}-1$
- otherwise, the result returned is the same as the value to be saturated.

For unsigned *n*-bit saturation using USAT, this means that:

- If the value to be saturated is less than 0, the result returned is 0
- If the value to be saturated is greater than 2^n-1 , the result returned is 2^n-1
- Otherwise, the result returned is the same as the value to be saturated.

If the returned result is different from the value to be saturated, it is called *saturation*. If saturation occurs, the instruction sets the Q flag to 1 in the APSR. Otherwise, it leaves the Q flag unchanged. To clear the Q flag to 0, you must use the MSR instruction, see [MSR on page 101](#).

To read the state of the Q flag, use the MRS instruction (see [MRS on page 100](#)).

Restrictions

Do not use either SP or PC.

Condition flags

These instructions do not affect the condition code flags.

If saturation occurs, these instructions set the Q flag to 1.

Examples

```
SSATR7, #16, R7, LSL #4; logical shift left value in R7 by 4, then
; saturate it as a signed 16-bit value and
; write it back to R7
USATNER0, #7, R5; conditionally saturate value in R5 as an
; unsigned 7 bit value and write it to R0
```

3.8 Bitfield instructions

[Table 29](#) shows the instructions that operate on adjacent sets of bits in registers or bitfields.

Table 29. Packing and unpacking instructions

Mnemonic	Brief description	See
BFC	Bit field clear	BFC and BFI on page 89
BFI	Bit field insert	BFC and BFI on page 89
SBFX	Signed bit field extract	SBFX and UBFX on page 89
SXTB	Sign extend a byte	SXT and UXT on page 90
SXTH	Sign extend a halfword	SXT and UXT on page 90
UBFX	Unsigned bit field extract	SBFX and UBFX on page 89
UXTB	Zero extend a byte	SXT and UXT on page 90
UXTH	Zero extend a halfword	SXT and UXT on page 90

3.8.1 BFC and BFI

Bit Field Clear and Bit Field Insert.

Syntax

```
BFC{cond} Rd, #lsb, #width
```

```
BFI{cond} Rd, Rn, #lsb, #width
```

where:

- ‘*cond*’ is an optional condition code, see [Conditional execution on page 57](#).
- ‘*Rd*’ is the destination register.
- ‘*Rn*’ is the source register.
- ‘*lsb*’ is the position of the least significant bit of the bitfield. *lsb* must be in the range 0 to 31.
- ‘*width*’ is the width of the bitfield and must be in the range 1 to 32-*lsb*.

Operation

BFC clears a bitfield in a register. It clears width bits in *Rd*, starting at the low bit position *lsb*. Other bits in *Rd* are unchanged.

BFI copies a bitfield into one register from another register. It replaces width bits in *Rd* starting at the low bit position *lsb*, with width bits from *Rn* starting at bit[0]. Other bits in *Rd* are unchanged.

Restrictions

Do not use SP and do not use PC.

Condition flags

These instructions do not affect the flags.

Examples

```
BFC   R4, #8, #12      ; Clear bit 8 to bit 19 (12 bits) of R4 to 0
BFI   R9, R2, #8, #12  ; Replace bit 8 to bit 19 (12 bits) of R9 with
                        ; bit 0 to bit 11 from R2
```

3.8.2 SBFX and UBFX

Signed Bit Field Extract and Unsigned Bit Field Extract.

Syntax

```
SBFX{cond} Rd, Rn, #lsb, #width
```

```
UBFX{cond} Rd, Rn, #lsb, #width
```

where:

- ‘*cond*’ is an optional condition code, see [Conditional execution on page 57](#).
- ‘*Rd*’ is the destination register.
- ‘*Rn*’ is the source register.
- ‘*lsb*’ is the position of the least significant bit of the bitfield. *lsb* must be in the range 0 to 31.
- ‘*width*’ is the width of the bitfield and must be in the range 1 to 32-*lsb*.

Operation

SBFX extracts a bitfield from one register, sign extends it to 32 bits, and writes the result to the destination register.

UBFX extracts a bitfield from one register, zero extends it to 32 bits, and writes the result to the destination register.

Restrictions

Do not use SP and do not use PC.

Condition flags

These instructions do not affect the flags.

Examples

```
SBFX R0, R1, #20, #4 ; Extract bit 20 to bit 23 (4 bits) from R1 and sign
                    ; extend to 32 bits and then write the result to R0.
UBFX R8, R11, #9, #10 ; Extract bit 9 to bit 18 (10 bits) from R11 and zero
                    ; extend to 32 bits and then write the result to R8
```

3.8.3 SXT and UXT

Sign extend and Zero extend.

Syntax

```
SXTextend{cond} {Rd}, Rm {, ROR #n}
```

```
UXTextend{cond} {Rd}, Rm {, ROR #n}
```

where:

- ‘extend’ is one of:
 - B: Extends an 8-bit value to a 32-bit value.
 - H: Extends a 16-bit value to a 32-bit value.
- ‘*cond*’ is an optional condition code, see [Conditional execution on page 57](#).
- ‘*Rd*’ is the destination register.
- ‘*Rm*’ is the register holding the value to extend.
- ROR #*n* is one of:
 - ROR #8: Value from *Rm* is rotated right 8 bits.
 - ROR #16: Value from *Rm* is rotated right 16 bits.
 - ROR #24: Value from *Rm* is rotated right 24 bits.
 If ROR #*n* is omitted, no rotation is performed.

Operation

These instructions do the following:

1. Rotate the value from *Rm* right by 0, 8, 16 or 24 bits.
2. Extract bits from the resulting value:
 - SXTB extracts bits[7:0] and sign extends to 32 bits.
 - UXTB extracts bits[7:0] and zero extends to 32 bits.
 - SXTH extracts bits[15:0] and sign extends to 32 bits.
 - UXTH extracts bits[15:0] and zero extends to 32 bits.

Restrictions

Do not use SP and do not use PC.

Condition flags

These instructions do not affect the flags.

Examples

```
SXTH  R4, R6, ROR #16 ; Rotate R6 right by 16 bits, then obtain the lower
                        ; halfword of the result and then sign extend to
                        ; 32 bits and write the result to R4.
UXTB  R3, R10         ; Extract lowest byte of the value in R10 and zero
                        ; extend it, and write the result to R3
```

3.8.4 Branch and control instructions

[Table 30](#) shows the branch and control instructions:

Table 30. Branch and control instructions

Mnemonic	Brief description	See
B	Branch	B, BL, BX, and BLX on page 92
BL	Branch with Link	B, BL, BX, and BLX on page 92
BLX	Branch indirect with Link	B, BL, BX, and BLX on page 92
BX	Branch indirect	B, BL, BX, and BLX on page 92
CBNZ	Compare and Branch if Non Zero	CBZ and CBNZ on page 93
CBZ	Compare and Branch if Non Zero	CBZ and CBNZ on page 93
IT	If-Then	IT on page 94
TBB	Table Branch Byte	TBB and TBH on page 96
TBH	Table Branch Halfword	TBB and TBH on page 96

3.8.5 B, BL, BX, and BLX

Branch instructions.

Syntax

`B{cond} label`

`BL{cond} label`

`BX{cond} Rm`

`BLX{cond} Rm`

where:

- ‘B’ is branch (immediate).
- ‘BL’ is branch with link (immediate).
- ‘BX’ is branch indirect (register).
- ‘BLX’ is branch indirect with link (register).
- ‘cond’ is an optional condition code, see [Conditional execution on page 57](#).
- ‘label’ is a PC-relative expression. See [PC-relative expressions on page 56](#).
- ‘Rm’ is a register that indicates an address to branch to. Bit[0] of the value in *Rm* must be 1, but the address to branch to is created by changing bit[0] to 0.

Operation

All these instructions cause a branch to *label*, or to the address indicated in *Rm*. In addition:

- The BL and BLX instructions write the address of the next instruction to LR (the link register, R14).
- The BX and BLX instructions cause a UsageFault exception if bit[0] of *Rm* is 0.

`B cond label` is the only conditional instruction that can be either inside or outside an IT block. All other branch instructions must be conditional inside an IT block, and must be unconditional outside the IT block, see [IT on page 94](#).

[Table 31](#) shows the ranges for the various branch instructions.

Table 31. Branch ranges

Instruction	Branch range
B label	–16 MB to +16 MB
Bcond label (outside IT block)	–1 MB to +1 MB
Bcond label (inside IT block)	–16 MB to +16 MB
BL{cond} label	–16 MB to +16 MB
BX{cond} Rm	Any value in register
BLX{cond} Rm	Any value in register

You might have to use the `.W` suffix to get the maximum branch range. See [Instruction width selection on page 59](#).

Restrictions

The restrictions are:

- Do not use PC in the BLX instruction
- For BX and BLX, bit[0] of *Rm* must be 1 for correct execution but a branch occurs to the target address created by changing bit[0] to 0
- When any of these instructions is inside an IT block, it must be the last instruction of the IT block.

Bcond is the only conditional instruction that is not required to be inside an IT block. However, it has a longer branch range when it is inside an IT block.

Condition flags

These instructions do not change the flags.

Examples

```

B      loopA ; Branch to loopA
BLE   ng    ; Conditionally branch to label ng
B.W   target ; Branch to target within 16MB range
BEQ   target ; Conditionally branch to target
BEQ.W target ; Conditionally branch to target within 1MB
BL    funC  ; Branch with link (Call) to function funC, return address
      ; stored in LR
BX    LR    ; Return from function call
BXNE  R0    ; Conditionally branch to address stored in R0
BLX   R0    ; Branch with link and exchange (Call) to a address stored
      ; in R0

```

3.8.6 CBZ and CBNZ

Compare and branch on zero, compare and branch on non-zero.

Syntax

```
CBZ Rn, label
```

```
CBNZ Rn, label
```

where:

- '*Rn*' is the register holding the operand.
- '*label*' is the branch destination.

Operation

Use the CBZ or CBNZ instructions to avoid changing the condition code flags and to reduce the number of instructions.

CBZ *Rn*, *label* does not change condition flags but is otherwise equivalent to:

```

CMP    Rn, #0
BEQ    label

```

CBNZ *Rn*, *label* does not change condition flags but is otherwise equivalent to:

```

CMP      Rn, #0
BNE     label

```

Restrictions

The restrictions are:

- *Rn* must be in the range of R0 to R7
- The branch destination must be within 4 to 130 bytes after the instruction
- These instructions must not be used inside an IT block.

Condition flags

These instructions do not change the flags.

Examples

```

CBZ     R5, target ; Forward branch if R5 is zero
CBNZ    R0, target ; Forward branch if R0 is not zero

```

3.8.7 IT

If-Then condition instruction.

Syntax

```
IT{x{y{z}}} cond
```

where:

- 'x' specifies the condition switch for the second instruction in the IT block.
- 'y' specifies the condition switch for the third instruction in the IT block.
- 'z' specifies the condition switch for the fourth instruction in the IT block.
- 'cond' specifies the condition for the first instruction in the IT block.

The condition switch for the second, third and fourth instruction in the IT block can be either:

T: Then. Applies the condition *cond* to the instruction.

E: Else. Applies the inverse condition of *cond* to the instruction.

- It is possible to use AL (the *always* condition) for *cond* in an IT instruction. If this is done, all of the instructions in the IT block must be unconditional, and each of x, y, and z must be T or omitted but not E.

Operation

The IT instruction makes up to four following instructions conditional. The conditions can be all the same, or some of them can be the logical inverse of the others. The conditional instructions following the IT instruction form the *IT block*.

The instructions in the IT block, including any branches, must specify the condition in the {*cond*} part of their syntax.

Your assembler might be able to generate the required IT instructions for conditional instructions automatically, so that you do not need to write them yourself. See your assembler documentation for details.

A BKPT instruction in an IT block is always executed, even if its condition fails.

Exceptions can be taken between an IT instruction and the corresponding IT block, or within an IT block. Such an exception results in entry to the appropriate exception handler, with suitable return information in LR and stacked PSR.

Instructions designed for use for exception returns can be used as normal to return from the exception, and execution of the IT block resumes correctly. This is the only way that a PC-modifying instruction is permitted to branch to an instruction in an IT block.

Restrictions

The following instructions are not permitted in an IT block:

- IT
- CBZ and CBNZ
- CPSID and CPSIE.

Other restrictions when using an IT block are:

- a branch or any instruction that modifies the PC must either be outside an IT block or must be the last instruction inside the IT block. These are:
 - ADD PC, PC, Rm
 - MOV PC, Rm
 - B, BL, BX, BLX
 - any LDM, LDR, or POP instruction that writes to the PC
 - TBB and TBH
- Do not branch to any instruction inside an IT block, except when returning from an exception handler
- All conditional instructions except *Bcond* must be inside an IT block. *Bcond* can be either outside or inside an IT block but has a larger branch range if it is inside one
- Each instruction inside the IT block must specify a condition code suffix that is either the same or logical inverse as for the other instructions in the block.

Your assembler might place extra restrictions on the use of IT blocks, such as prohibiting the use of assembler directives within them.

Condition flags

This instruction does not change the flags.

Example

```
ITTE  NE           ; Next 3 instructions are conditional
ANDNE R0, R0, R1  ; ANDNE does not update condition flags
ADDSNE R2, R2, #1 ; ADDSNE updates condition flags
MOVEQ  R2, R3     ; Conditional move
```

```

CMP    R0, #9      ; Convert R0 hex value (0 to 15) into ASCII
                ; ('0'-'9', 'A'-'F')
ITE    GT          ; Next 2 instructions are conditional
ADDGT  R1, R0, #55 ; Convert 0xA -> 'A'
ADDLE  R1, R0, #48 ; Convert 0x0 -> '0'

IT     GT          ; IT block with only one conditional instruction
ADDGT  R1, R1, #1  ; Increment R1 conditionally

ITTEE  EQ          ; Next 4 instructions are conditional
MOVEQ  R0, R1      ; Conditional move
ADDEQ  R2, R2, #10 ; Conditional add
ANDNE  R3, R3, #1  ; Conditional AND
BNE.W  dloop       ; Branch instruction can only be used in the last
                ; instruction of an IT block

IT     NE          ; Next instruction is conditional
ADD    R0, R0, R1  ; Syntax error: no condition code used in IT block

```

3.8.8 TBB and TBH

Table Branch Byte and Table Branch Halfword.

Syntax

TBB [*Rn*, *Rm*]

TBH [*Rn*, *Rm*, LSL #1]

where:

- '*Rn*' is the register containing the address of the table of branch lengths. If *Rn* is PC, then the address of the table is the address of the byte immediately following the TBB or TBH instruction.
- '*Rm*' is the index register. This contains an index into the table. For halfword tables, LSL #1 doubles the value in *Rm* to form the right offset into the table.

Operation

These instructions cause a PC-relative forward branch using a table of single byte offsets for TBB, or halfword offsets for TBH. *Rn* provides a pointer to the table, and *Rm* supplies an index into the table. For TBB the branch offset is twice the unsigned value of the byte returned from the table. and for TBH the branch offset is twice the unsigned value of the halfword returned from the table. The branch occurs to the address at that offset from the address of the byte immediately after the TBB or TBH instruction.

Restrictions

The restrictions are:

- *Rn* must not be SP
- *Rm* must not be SP and must not be PC
- When any of these instructions is used inside an IT block, it must be the last instruction of the IT block.

Condition flags

These instructions do not change the flags.

Examples

```

ADR.W R0, BranchTable_Byte
TBB [R0, R1] ; R1 is the index, R0 is the base address of the
; branch table

Case1
; an instruction sequence follows
Case2
; an instruction sequence follows
Case3
; an instruction sequence follows
BranchTable_Byte
DCB 0 ; Case1 offset calculation
DCB ((Case2-Case1)/2) ; Case2 offset calculation
DCB ((Case3-Case1)/2) ; Case3 offset calculation

TBH [PC, R1, LSL #1] ; R1 is the index, PC is used as base of the
; branch table

BranchTable_H
DCI ((CaseA - BranchTable_H)/2) ; CaseA offset calculation
DCI ((CaseB - BranchTable_H)/2) ; CaseB offset calculation
DCI ((CaseC - BranchTable_H)/2) ; CaseC offset calculation

CaseA
; an instruction sequence follows
CaseB
; an instruction sequence follows
CaseC
; an instruction sequence follows

```

3.9 Miscellaneous instructions

[Table 32](#) shows the remaining Cortex-M3 instructions:

Table 32. Miscellaneous instructions

Mnemonic	Brief description	See
BKPT	Breakpoint	BKPT on page 98
CPSID	Change Processor State, Disable Interrupts	CPS on page 98
CPSIE	Change Processor State, Enable Interrupts	CPS on page 98
DMB	Data Memory Barrier	DMB on page 99
DSB	Data Synchronization Barrier	DSB on page 100
ISB	Instruction Synchronization Barrier	ISB on page 100
MRS	Move from special register to register	MRS on page 100
MSR	Move from register to special register	MSR on page 101

Table 32. Miscellaneous instructions (continued)

Mnemonic	Brief description	See
NOP	No Operation	NOP on page 102
SEV	Send Event	SEV on page 102
SVC	Supervisor Call	SVC on page 103
WFE	Wait For Event	WFE on page 103
WFI	Wait For Interrupt	WFI on page 104

3.9.1 BKPT

Breakpoint.

Syntax

`BKPT #imm`

where:

- ‘*imm*’ is an expression evaluating to an integer in the range 0-255 (8-bit value).

Operation

The BKPT instruction causes the processor to enter Debug state. Debug tools can use this to investigate system state when the instruction at a particular address is reached.

imm is ignored by the processor. If required, a debugger can use it to store additional information about the breakpoint.

The BKPT instruction can be placed inside an IT block, but it executes unconditionally, unaffected by the condition specified by the IT instruction.

Condition flags

This instruction does not change the flags.

Examples

```
BKPT 0xAB ; Breakpoint with immediate value set to 0xAB (debugger can
           ; extract the immediate value by locating it using the PC)
```

3.9.2 CPS

Change Processor State.

Syntax

`CPSeffect iflags`

where:

- *'effect'* is one of:
 - IE: Clears the special purpose register.
 - ID: Sets the special purpose register.
- *'iflags'* is a sequence of one or more flags:
 - i: Set or clear PRIMASK.
 - f: Set or clear FAULTMASK.

Operation

CPS changes the PRIMASK and FAULTMASK special register values. See [Exception mask registers on page 19](#) for more information about these registers.

Restrictions

The restrictions are:

- Use CPS only from privileged software, it has no effect if used in unprivileged software
- CPS cannot be conditional and so must not be used inside an IT block.

Condition flags

This instruction does not change the condition flags.

Examples

```
CPSID i ; Disable interrupts and configurable fault handlers (set PRIMASK)
CPSID f ; Disable interrupts and all fault handlers (set FAULTMASK)
CPSIE i ; Enable interrupts and configurable fault handlers (clear PRIMASK)
CPSIE f ; Enable interrupts and fault handlers (clear FAULTMASK)
```

3.9.3 DMB

Data Memory Barrier.

Syntax

```
DMB{cond}
```

where:

- *'cond'* is an optional condition code, see [Conditional execution on page 57](#).

Operation

DMB acts as a data memory barrier. It ensures that all explicit memory accesses that appear, in program order, before the DMB instruction are completed before any explicit memory accesses that appear, in program order, after the DMB instruction. DMB does not affect the ordering or execution of instructions that do not access memory.

Condition flags

This instruction does not change the flags.

Examples

```
DMB ; Data Memory Barrier
```

3.9.4 DSB

Data Synchronization Barrier.

Syntax

`DSB{cond}`

where:

- ‘*cond*’ is an optional condition code, see [Conditional execution on page 57](#).

Operation

DSB acts as a special data synchronization memory barrier. Instructions that come after the DSB, in program order, do not execute until the DSB instruction completes. The DSB instruction completes when all explicit memory accesses before it complete.

Condition flags

This instruction does not change the flags.

Examples

```
DSB ; Data Synchronisation Barrier
```

3.9.5 ISB

Instruction Synchronization Barrier.

Syntax

`ISB{cond}`

where:

- ‘*cond*’ is an optional condition code, see [Conditional execution on page 57](#).

Operation

ISB acts as an instruction synchronization barrier. It flushes the pipeline of the processor, so that all instructions following the ISB are fetched from cache or memory again, after the ISB instruction has been completed.

Condition flags

This instruction does not change the flags.

Examples

```
ISB ; Instruction Synchronisation Barrier
```

3.9.6 MRS

Move the contents of a special register to a general-purpose register.

Syntax

`MRS{cond} Rd, spec_reg`

where:

- ‘*cond*’ is an optional condition code, see [Conditional execution on page 57](#).
- ‘*Rd*’ is the destination register.
- ‘*spec_reg*’ can be any of: APSR, IPSR, EPSR, IEPSR, IAPSR, EAPSR, PSR, MSP, PSP, PRIMASK, BASEPRI, BASEPRI_MAX, FAULTMASK, or CONTROL.

Operation

Use MRS in combination with MSR as part of a read-modify-write sequence for updating a PSR, for example to clear the Q flag.

In process swap code, the programmers model state of the process being swapped out must be saved, including relevant PSR contents. Similarly, the state of the process being swapped in must also be restored. These operations use MRS in the state-saving instruction sequence and MSR in the state-restoring instruction sequence.

BASEPRI_MAX is an alias of BASEPRI when used with the MRS instruction.

See [MSR on page 101](#).

Restrictions

Rd must not be SP and must not be PC.

Condition flags

This instruction does not change the flags.

Examples

```
MRS R0, PRIMASK ; Read PRIMASK value and write it to R0
```

3.9.7 MSR

Move the contents of a general-purpose register into the specified special register.

Syntax

```
MSR{cond} spec_reg, Rn
```

where:

- ‘*cond*’ is an optional condition code, see [Conditional execution on page 57](#).
- ‘*Rn*’ is the source register.
- ‘*spec_reg*’ can be any of: APSR, IPSR, EPSR, IEPSR, IAPSR, EAPSR, PSR, MSP, PSP, PRIMASK, BASEPRI, BASEPRI_MAX, FAULTMASK, or CONTROL.

Operation

The register access operation in MSR depends on the privilege level. Unprivileged software can only access the APSR, see [Table 4: APSR bit definitions on page 17](#). Privileged software can access all special registers.

In unprivileged software writes to unallocated or execution state bits in the PSR are ignored.

When you write to BASEPRI_MAX, the instruction writes to BASEPRI only if either:

- *Rn* is non-zero and the current BASEPRI value is 0
- *Rn* is non-zero and less than the current BASEPRI value.

See [MRS on page 100](#).

Restrictions

Rn must not be SP and must not be PC.

Condition flags

This instruction updates the flags explicitly based on the value in *Rn*.

Examples

```
MSR CONTROL, R1 ; Read R1 value and write it to the CONTROL register
```

3.9.8 NOP

No Operation.

Syntax

```
NOP{cond}
```

where:

- '*cond*' is an optional condition code, see [Conditional execution on page 57](#).

Operation

NOP does nothing. NOP is not necessarily a time-consuming NOP. The processor might remove it from the pipeline before it reaches the execution stage.

Use NOP for padding, for example to place the following instruction on a 64-bit boundary.

Condition flags

This instruction does not change the flags.

Examples

```
NOP ; No operation
```

3.9.9 SEV

Send Event.

Syntax

```
SEV{cond}
```

where:

- '*cond*' is an optional condition code, see [Conditional execution on page 57](#).

Operation

SEV is a hint instruction that causes an event to be signaled to all processors within a multiprocessor system. It also sets the local event register to 1, see [Power management on page 42](#).

Condition flags

This instruction does not change the flags.

Examples

```
SEV ; Send Event
```

3.9.10 SVC

Supervisor Call.

Syntax

```
SVC{cond} #imm
```

where:

- '*cond*' is an optional condition code, see [Conditional execution on page 57](#).
- '*imm*' is an expression evaluating to an integer in the range 0-255 (8-bit value).

Operation

The SVC instruction causes the SVC exception.

imm is ignored by the processor. If required, it can be retrieved by the exception handler to determine what service is being requested.

Condition flags

This instruction does not change the flags.

Examples

```
SVC 0x32 ; Supervisor Call (SVC handler can extract the immediate value  
; by locating it via the stacked PC)
```

3.9.11 WFE

Wait For Event.

Syntax

```
WFE{cond}
```

where:

- '*cond*' is an optional condition code, see [Conditional execution on page 57](#).

Operation

WFE is a hint instruction.

If the event register is 0, WFE suspends execution until one of the following events occurs:

- An exception, unless masked by the exception mask registers or the current priority level
- An exception enters the Pending state, if SEVONPEND in the System Control Register is set
- A Debug Entry request, if Debug is enabled
- An event signaled by a peripheral or another processor in a multiprocessor system using the SEV instruction.

If the event register is 1, WFE clears it to 0 and returns immediately.

For more information see [Power management on page 42](#).

Condition flags

This instruction does not change the flags.

Examples

```
WFE ; Wait for event
```

3.9.12 WFI

Wait for Interrupt.

Syntax

```
WFI{cond}
```

where:

- 'cond' is an optional condition code, see [Conditional execution on page 57](#).

Operation

WFI is a hint instruction that suspends execution until one of the following events occurs:

- An exception
- A Debug Entry request, regardless of whether Debug is enabled.

Condition flags

This instruction does not change the flags.

Examples

```
WFI ; Wait for interrupt
```

4 Core peripherals

4.1 About the STM32 core peripherals

The address map of the *Private peripheral bus* (PPB) is:

Table 33. STM32 core peripheral register regions

Address	Core peripheral	Description
0xE000E010-0xE000E01F	System timer	Table 49 on page 154
0xE000E100-0xE000E4EF	Nested vectored interrupt controller	Table 44 on page 128
0xE000ED00-0xE000ED3F	System control block	Table 48 on page 149
0xE000ED90-0xE000ED93	Memory protection unit	Table 40 on page 117⁽¹⁾
0xE000EF00-0xE000EF03	Nested vectored interrupt controller	Table 44 on page 128

1. Software can read the MPU Type Register at 0xE000ED90 to test for the presence of a *memory protection unit* (MPU).

In register descriptions:

- The *required privilege* gives the privilege level required to access the register, as follows:
 - Privileged** Only privileged software can access the register.
 - Unprivileged** Both unprivileged and privileged software can access the register.

4.2 Memory protection unit (MPU)

This section describes the Memory protection unit (MPU) which is implemented in some STM32 microcontrollers. Refer to the corresponding device datasheet to see if the MPU is present in the STM32 type you are using.

The MPU divides the memory map into a number of regions, and defines the location, size, access permissions, and memory attributes of each region. It supports:

- Independent attribute settings for each region
- Overlapping regions
- Export of memory attributes to the system.

The memory attributes affect the behavior of memory accesses to the region. The Cortex-M3 MPU defines:

- Eight separate memory regions, 0-7
- A background region.

When memory regions overlap, a memory access is affected by the attributes of the region with the highest number. For example, the attributes for region 7 take precedence over the attributes of any region that overlaps region 7.

The background region has the same memory access attributes as the default memory map, but is accessible from privileged software only.

The Cortex-M3 MPU memory map is unified. This means instruction accesses and data accesses have same region settings.

If a program accesses a memory location that is prohibited by the MPU, the processor generates a memory management fault. This causes a fault exception, and might cause termination of the process in an OS environment.

In an OS environment, the kernel can update the MPU region setting dynamically based on the process to be executed. Typically, an embedded OS uses the MPU for memory protection.

Configuration of MPU regions is based on memory types, see [Section 2.2.1: Memory regions, types and attributes on page 25](#).

[Table 34](#) shows the possible MPU region attributes.

Table 34. Memory attributes summary

Memory type	Shareability	Other attributes	Description
Strongly- ordered	-	-	All accesses to Strongly-ordered memory occur in program order. All Strongly-ordered regions are assumed to be shared.
Device	Shared	-	Memory-mapped peripherals that several processors share.
	Non-shared	-	Memory-mapped peripherals that only a single processor uses.
Normal	Shared	Non-cacheable Write-through Cacheable Write-back Cacheable	Normal memory that is shared between several processors.
	Non-shared	Non-cacheable Write-through Cacheable Write-back Cacheable	Normal memory that only a single processor uses.

4.2.1 MPU access permission attributes

This section describes the MPU access permission attributes. The access permission bits, TEX, C, B, S, AP, and XN, of the MPU_RASR register, control access to the corresponding memory region. If an access is made to an area of memory without the required permissions, then the MPU generates a permission fault.

[Table 35](#) shows the encodings for the TEX, C, B, and S access permission bits.

Table 35. TEX, C, B, and S encoding

TEX	C	B	S	Memory type	Shareability	Other attributes	
b000	0	0	x ⁽¹⁾	Strongly-ordered	Shareable	-	
		1	x ⁽¹⁾	Device	Shareable	-	
	1	0	0	Normal	Not shareable	Outer and inner write-through. No write allocate.	
			1		Shareable		
		1	0	Normal	Not shareable		Outer and inner write-back. No write allocate.
			1		Shareable		
b001	0	0	0	Normal	Not shareable	Outer and inner Non-cacheable.	
			1		Shareable		
		1	x ⁽¹⁾	Reserved encoding			-
	1	0	x ⁽¹⁾	Implementation defined attributes.			-
		1	0	Normal	Not shareable	Outer and inner write-back. Write and read allocate.	
			1		Shareable		
1	x ⁽¹⁾	Reserved encoding		-			
b010	0	0	x ⁽¹⁾	Device	Not shareable		Non-shared Device.
		1	x ⁽¹⁾	Reserved encoding		-	
	1	x ⁽¹⁾	x ⁽¹⁾	Reserved encoding		-	
b1BB	A	A	0	Normal	Not shareable	Cached memory ⁽²⁾ , BB = outer policy, AA = inner policy.	
			1		Shareable		

1. The MPU ignores the value for this bit.
2. See [Table 36](#) for the encoding of the AA and BB bits.

[Table 36](#) shows the cache policy for memory attribute encodings with a TEX value is in the range 4-7.

Table 36. Cache policy for memory attribute encoding

Encoding, AA or BB	Corresponding cache policy
00	Non-cacheable
01	Write back, write and read allocate
10	Write through, no write allocate
11	Write back, no write allocate

[Table 37](#) shows the AP encodings that define the access permissions for privileged and unprivileged software.

Table 37. AP encoding

AP[2:0]	Privileged permissions	Unprivileged permissions	Description
000	No access	No access	All accesses generate a permission fault
001	RW	No access	Access from privileged software only
010	RW	RO	Writes by unprivileged software generate a permission fault
011	RW	RW	Full access
100	Unpredictable	Unpredictable	Reserved
101	RO	No access	Reads by privileged software only
110	RO	RO	Read only, by privileged or unprivileged software
111	RO	RO	Read only, by privileged or unprivileged software

4.2.2 MPU mismatch

When an access violates the MPU permissions, the processor generates a memory management fault, see [Section 2.1.4: Exceptions and interrupts on page 22](#). The MMFSR indicates the cause of the fault. See [Section 4.4.12: Memory management fault address register \(SCB_MMFAR\) on page 147](#) for more information.

4.2.3 Updating an MPU region

To update the attributes for an MPU region, update the MPU_RNR, MPU_RBAR and MPU_RASR registers. You can program each register separately, or use a multiple-word write to program all of these registers. You can use the MPU_RBAR and MPU_RASR aliases to program up to four regions simultaneously using an STM instruction.

Updating an MPU region using separate words

Simple code to configure one region:

```
; R1 = region number
; R2 = size/enable
; R3 = attributes
; R4 = address
LDR R0,=MPU_RNR           ; 0xE000ED98, MPU region number register
STR R1, [R0, #0x0]       ; Region Number
STR R4, [R0, #0x4]       ; Region Base Address
STRH R2, [R0, #0x8]      ; Region Size and Enable
STRH R3, [R0, #0xA]      ; Region Attribute
```

Disable a region before writing new region settings to the MPU if you have previously enabled the region being changed. For example:

```
; R1 = region number
; R2 = size/enable
; R3 = attributes
; R4 = address
LDR R0,=MPU_RNR           ; 0xE000ED98, MPU region number register
STR R1, [R0, #0x0]       ; Region Number
BIC R2, R2, #1           ; Disable
STRH R2, [R0, #0x8]      ; Region Size and Enable
STR R4, [R0, #0x4]       ; Region Base Address
```

```

STRH R3, [R0, #0xA]      ; Region Attribute
ORR R2, #1               ; Enable
STRH R2, [R0, #0x8]     ; Region Size and Enable

```

Software must use memory barrier instructions:

- Before MPU setup if there might be outstanding memory transfers, such as buffered writes, that might be affected by the change in MPU settings
- After MPU setup if it includes memory transfers that must use the new MPU settings.

However, memory barrier instructions are not required if the MPU setup process starts by entering an exception handler, or is followed by an exception return, because the exception entry and exception return mechanism cause memory barrier behavior.

Software does not need any memory barrier instructions during MPU setup, because it accesses the MPU through the PPB, which is a Strongly-Ordered memory region.

For example, if you want all of the memory access behavior to take effect immediately after the programming sequence, use a DSB instruction and an ISB instruction. A DSB is required after changing MPU settings, such as at the end of context switch. An ISB is required if the code that programs the MPU region or regions is entered using a branch or call. If the programming sequence is entered using a return from exception, or by taking an exception, then you do not require an ISB.

Updating an MPU region using multi-word writes

You can program directly using multi-word writes, depending on how the information is divided. Consider the following reprogramming:

```

; R1 = region number
; R2 = address
; R3 = size, attributes in one
LDR R0, =MPU_RNR      ; 0xE000ED98, MPU region number register
STR R1, [R0, #0x0]   ; Region Number
STR R2, [R0, #0x4]   ; Region Base Address
STR R3, [R0, #0x8]   ; Region Attribute, Size and Enable

```

Use an STM instruction to optimize this:

```

; R1 = region number
; R2 = address
; R3 = size, attributes in one
LDR R0, =MPU_RNR      ; 0xE000ED98, MPU region number register
STM R0, {R1-R3}      ; Region Number, address, attribute, size and enable

```

You can do this in two words for pre-packed information. This means that the RBAR contains the required region number and had the VALID bit set to 1, see [MPU region base address register \(MPU_RBAR\) on page 114](#). Use this when the data is statically packed, for example in a boot loader:

```

; R1 = address and region number in one
; R2 = size and attributes in one
LDR R0, =MPU_RBAR     ; 0xE000ED9C, MPU Region Base register
STR R1, [R0, #0x0]   ; Region base address and
                    ; region number combined with VALID (bit 4) set to 1
STR R2, [R0, #0x4]   ; Region Attribute, Size and Enable

```

Use an STM instruction to optimize this:

```

; R1 = address and region number in one
; R2 = size and attributes in one
LDR R0, =MPU_RBAR     ; 0xE000ED9C, MPU Region Base register
STM R0, {R1-R2}      ; Region base address, region number and VALID bit,
                    ; and Region Attribute, Size and Enable

```

Subregions

Regions of 256 bytes or more are divided into eight equal-sized subregions. Set the corresponding bit in the SRD field of the RASR to disable a subregion, see [Section 4.2.9: MPU region attribute and size register \(MPU_RASR\) on page 116](#). The least significant bit of SRD controls the first subregion, and the most significant bit controls the last subregion. Disabling a subregion means another region overlapping the disabled range matches instead. If no other enabled region overlaps the disabled subregion the MPU issues a fault.

Regions of 32, 64, and 128 bytes do not support subregions, With regions of these sizes, you must set the SRD field to 0x00, otherwise the MPU behavior is Unpredictable.

Example of SRD use:

Two regions with the same base address overlap. Region one is 128KB, and region two is 512KB. To ensure the attributes from region one apply to the first 128KB region, set the SRD field for region two to b00000011 to disable the first two subregions, as the figure shows.

Figure 18. Subregion example

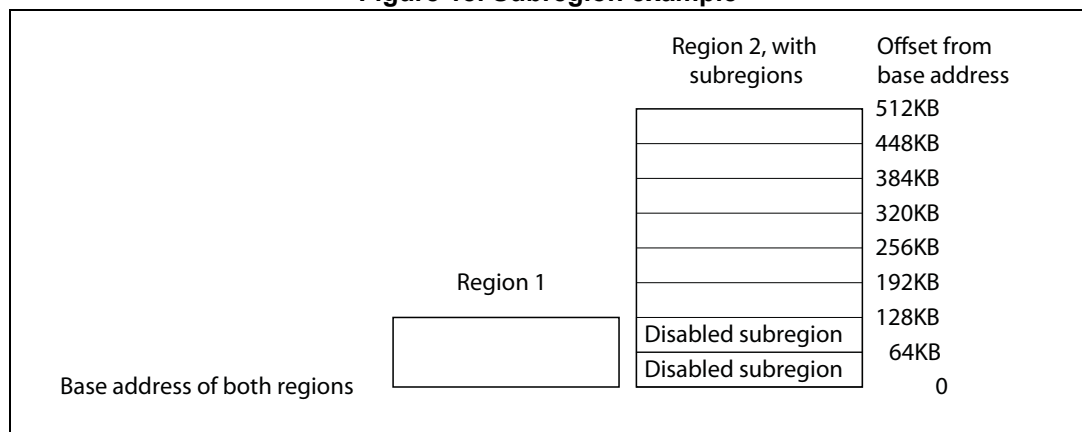

4.2.4 MPU design hints and tips

To avoid unexpected behavior, disable the interrupts before updating the attributes of a region that the interrupt handlers might access.

Ensure software uses aligned accesses of the correct size to access MPU registers:

- Except for the RASR, it must use aligned word accesses
- For the RASR it can use byte or aligned halfword or word accesses.

The processor does not support unaligned accesses to MPU registers.

When setting up the MPU, and if the MPU has previously been programmed, disable unused regions to prevent any previous region settings from affecting the new MPU setup.

Recommended MPU configuration

The STM32 microcontroller system has only a single processor, so you should program the MPU as follows:

Table 38. Memory region attributes for STM32

Memory region	TEX	C	B	S	Memory type and attributes
Flash memory	b000	1	0	0	Normal memory, Non-shareable, write-through
Internal SRAM	b000	1	0	1	Normal memory, Shareable, write-through
External SRAM	b000	1	1	1	Normal memory, Shareable, write-back, write-allocate
Peripherals	b000	0	1	1	Device memory, Shareable

In STM32 implementations, the shareability and cache policy attributes do not affect the system behavior. However, using these settings for the MPU regions can make the application code more portable. The values given are for typical situations.

Note: The MPU attributes don't affect DMA data accesses to the memory/peripherals address spaces. therefore, in order to protect the memory areas against inadvertent DMA accesses, the MPU must control the SW/CPU access to the DMA registers.

4.2.5 MPU type register (MPU_TYPER)

Address offset: 0x00

Reset value: 0x0000 0800

Required privilege: Privileged

The MPU_TYPER register indicates whether the MPU is present, and if so, how many regions it supports.

31	30	29	28	27	26	25	24	23	22	21	20	19	18	17	16
Reserved								IREGION[7:0]							
								r	r	r	r	r	r	r	r
15	14	13	12	11	10	9	8	7	6	5	4	3	2	1	0
DREGION[7:0]								Reserved							SEPA RATE
r	r	r	r	r	r	r	r								r

Bits 31:24 **Reserved, forced by hardware to 0.**

Bits 23:16 **IREGION[7:0]:** Number of MPU instruction regions.

These bits indicates the number of supported MPU instruction regions.

Always contains 0x00. The MPU memory map is unified and is described by the DREGION field.

Bits 15:8 **DREGION[7:0]**: Number of MPU data regions.

These bits indicates the number of supported MPU data regions.

0x08: Eight MPU regions

0x00: MPU not present

Bits 7:1 **Reserved, forced by hardware to 0.**

Bit 0 **SEPARATE**: Separate flag

This bit indicates support for unified or separate instruction and data memory maps:

0 = Unified

1 = Separate

4.2.6 MPU control register (MPU_CR)

Address offset: 0x04

Reset value: 0x0000 0000

Required privilege: Privileged

The MPU_CR register:

- Enables the MPU
- Enables the default memory map background region
- Enables use of the MPU when in the hard fault, Non-maskable Interrupt (NMI), and FAULTMASK escalated handlers.

When ENABLE and PRIVDEFENA are both set to 1:

- For privileged accesses, the default memory map is as described in [Section 2.2: Memory model on page 24](#). Any access by privileged software that does not address an enabled memory region behaves as defined by the default memory map.
- Any access by unprivileged software that does not address an enabled memory region causes a memory management fault.

XN and Strongly-ordered rules always apply to the System Control Space regardless of the value of the ENABLE bit.

When the ENABLE bit is set to 1, at least one region of the memory map must be enabled for the system to function unless the PRIVDEFENA bit is set to 1. If the PRIVDEFENA bit is set to 1 and no regions are enabled, then only privileged software can operate.

When the ENABLE bit is set to 0, the system uses the default memory map. This has the same memory attributes as if the MPU is not implemented, see [Table 12: Memory access behavior on page 26](#). The default memory map applies to accesses from both privileged and unprivileged software.

When the MPU is enabled, accesses to the System Control Space and vector table are always permitted. Other areas are accessible based on regions and whether PRIVDEFENA is set to 1.

Unless HFNMIENA is set to 1, the MPU is not enabled when the processor is executing the handler for an exception with priority –1 or –2. These priorities are only possible when handling a hard fault or NMI exception, or when FAULTMASK is enabled. Setting the HFNMIENA bit to 1 enables the MPU when operating with these two priorities.

31	30	29	28	27	26	25	24	23	22	21	20	19	18	17	16
Reserved															
15	14	13	12	11	10	9	8	7	6	5	4	3	2	1	0
Reserved													PRIVDEFENA	HFNMIEA	ENABLE
													rw	rw	rw

Bits 31:0 **Reserved, forced by hardware to 0.**

Bit 2 **PRIVDEFENA:** Enable privileged software access to default memory map.

0: If the MPU is enabled, disables use of the default memory map. Any memory access to a location not covered by any enabled region causes a fault.

1: If the MPU is enabled, enables use of the default memory map as a background region for privileged software accesses.

Note: When enabled, the background region acts as if it is region number -1. Any region that is defined and enabled has priority over this default map.

If the MPU is disabled, the processor ignores this bit.

Bit 1 **HFNMIEA:** Enables the operation of MPU during hard fault, NMI, and FAULTMASK handlers.

When the MPU is enabled:

0: MPU is disabled during hard fault, NMI, and FAULTMASK handlers, regardless of the value of the ENABLE bit

1: The MPU is enabled during hard fault, NMI, and FAULTMASK handlers.

Note: When the MPU is disabled, if this bit is set to 1 the behavior is unpredictable.

Bit 0 **ENABLE:** Enables the MPU

0: MPU disabled

1: MPU enabled

4.2.7 MPU region number register (MPU_RNR)

Address offset: 0x08

Reset value: 0x0000 0000

Required privilege: Privileged

The MPU_RNR register selects which memory region is referenced by the MPU_RBAR and MPU_RASR registers.

31	30	29	28	27	26	25	24	23	22	21	20	19	18	17	16
Reserved															
15	14	13	12	11	10	9	8	7	6	5	4	3	2	1	0
Reserved								REGION[7:0]							
								rw	rw	rw	rw	rw	rw	rw	rw

Bits 31:8 **Reserved, forced by hardware to 0.**

Bits 7:0 **REGION[7:0]:** MPU region

These bits indicate the MPU region referenced by the MPU_RBAR and MPU_RASR registers. The MPU supports 8 memory regions, so the permitted values of this field are 0-7.

Normally, you write the required region number to this register before accessing the MPU_RBAR or MPU_RASR. However you can change the region number by writing to the MPU_RBAR register with the VALID bit set to 1, see [MPU region base address register \(MPU_RBAR\)](#). This write updates the value of the REGION field.

4.2.8 MPU region base address register (MPU_RBAR)

Address offset: 0x0C

Reset value: 0x0000 0000

Required privilege: Privileged

The MPU_RBAR register defines the base address of the MPU region selected by the MPU_RNR register, and can update the value of the MPU_RNR register.

Write to the MPU_RBAR register with the VALID bit set to 1 to change the current region number and update the MPU_RNR register.

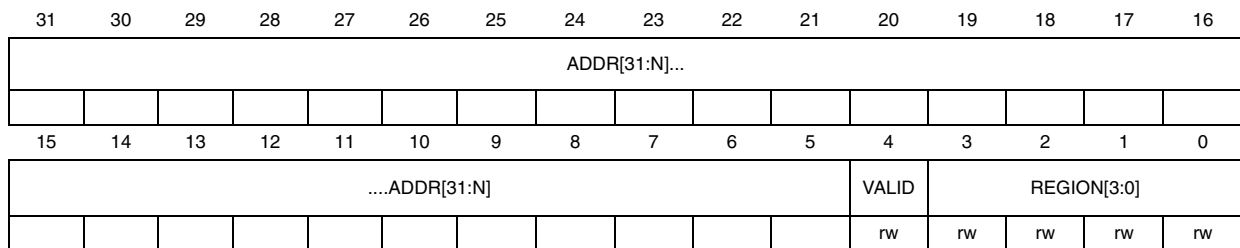

Bits 31:N **ADDR[31:N]**: Region base address field

The value of N depends on the region size.

The region size, as specified by the SIZE field in the RASR, defines the value of N:

$$N = \text{Log}_2(\text{Region size in bytes}),$$

If the region size is configured to 4 GB, in the MPU_RASR register, there is no valid ADDR field. In this case, the region occupies the complete memory map, and the base address is 0x00000000.

The base address is aligned to the size of the region. For example, a 64 KB region must be aligned on a multiple of 64 KB, for example, at 0x00010000 or 0x00020000.

Bits N-1:5 **Reserved, forced by hardware to 0.**

Bit 4 **VALID**: MPU region number valid

Write:

0: MPU_RNR register not changed, and the processor:

- Updates the base address for the region specified in the RNR
- Ignores the value of the REGION field

1: the processor:

- updates the value of the RNR to the value of the REGION field
- updates the base address for the region specified in the REGION field.

Read:

Always read as zero.

Bits 3:0 **REGION[3:0]**: MPU region field

For the behavior on writes, see the description of the VALID field.

On reads, returns the current region number, as specified by the MPU_RNR register.

4.2.9 MPU region attribute and size register (MPU_RASR)

Address offset: 0x10

Reset value: 0x0000 0000

Required privilege: Privileged

The MPU_RASR register defines the region size and memory attributes of the MPU region specified by the MPU_RNR, and enables that region and any subregions.

MPU_RASR is accessible using word or halfword accesses:

- The most significant halfword holds the region attributes
- The least significant halfword holds the region size and the region and subregion enable bits.

31	30	29	28	27	26	25	24	23	22	21	20	19	18	17	16	
Reserved			XN	Res.	AP[2:0]			Reserved			TEX[2:0]			S	C	B
			rw		rw	rw	rw			rw	rw	rw	rw	rw	rw	
15	14	13	12	11	10	9	8	7	6	5	4	3	2	1	0	
SRD[7:0]								Reserved		SIZE					EN ABLE	
rw	rw	rw	rw	rw	rw	rw	rw			rw	rw	rw	rw	rw	rw	

Bits 31:29 **Reserved, forced by hardware to 0.**

Bit 28 **XN**: Instruction access disable bit:

- 0: Instruction fetches enabled
- 1: Instruction fetches disabled.

Bit 27 **Reserved, forced by hardware to 0.**

Bits 26:24 **AP[2:0]**: Access permission

For information about access permission, see [Section 4: Core peripherals](#)

For the description of the encoding of the AP bits refer to [Table 37 on page 108](#).

Bits 23:22 **Reserved, forced by hardware to 0.**

Bits 21:19 **TEX[2:0]: memory attribute**

For the description of the encoding of the TEX bits refer to [Table 35 on page 107](#)

Bit 18 **S: Shareable memory attribute**

For the description of the encoding of the S bits refer to [Table 35 on page 107](#)

Bit 17 **C: memory attribute**

Bit 16 **B: memory attribute**

Bits 15:8 **SRD**: Subregion disable bits.

For each bit in this field:

- 0: corresponding sub-region is enabled
- 1: corresponding sub-region is disabled

See [Subregions on page 110](#) for more information.

Region sizes of 128 bytes and less do not support subregions. When writing the attributes for such a region, write the SRD field as 0x00.

Bits 7:6 **Reserved, forced by hardware to 0.**

Bits 5:1 **SIZE:** Size of the MPU protection region.

The minimum permitted value is 3 (b00010), see [SIZE field values](#) for more information.

Bit 0 **ENABLE:** Region enable bit.

SIZE field values

The SIZE field defines the size of the MPU memory region specified by the MPU_RNR register as follows:

$$(\text{Region size in bytes}) = 2(\text{SIZE}+1)$$

The smallest permitted region size is 32B, corresponding to a SIZE value of 4. Table 4-45 gives example SIZE values, with the corresponding region size and value of N in the RBAR.

Table 39. Example SIZE field values

SIZE value	Region size	Value of N ⁽¹⁾	Note
b00100 (4)	32B	5	Minimum permitted size
b01001 (9)	1KB	10	-
b10011 (19)	1MB	20	-
b11101 (29)	1GB	30	-
b11111 (31)	4GB	b01100	Maximum possible size

1. In the MPU_RBAR register see [Section 4.2.8 on page 114](#)

Table 40. MPU register map and reset values

Offset	Register	31	30	29	28	27	26	25	24	23	22	21	20	19	18	17	16	15	14	13	12	11	10	9	8	7	6	5	4	3	2	1	0
0x00	MPU_TYPER	Reserved								IREGION[7:0]							DREGION[7:0]							Reserved				SEPARATE					
	Reset Value	0	0	0	0	0	0	0	0	0	0	0	0	0	0	0	0	0	0	0	1	0	0	0	0	0	0	0	0	0	0	0	0
0x04	MPU_CR	Reserved																									PRIVDEFENA	HFNMENA	ENABLE				
	Reset Value	0	0	0	0	0	0	0	0	0	0	0	0	0	0	0	0	0	0	0	0	0	0	0	0	0	0	0	0	0	0	0	0
0x08	MPU_RNR	Reserved																							REGION[7:0]								
	Reset Value	0	0	0	0	0	0	0	0	0	0	0	0	0	0	0	0	0	0	0	0	0	0	0	0	0	0	0	0	0	0	0	
0x0C	MPU_RBAR	ADDR[31:N]...																									VALID	REGION [3:0]					
	Reset Value	0	0	0	0	0	0	0	0	0	0	0	0	0	0	0	0	0	0	0	0	0	0	0	0	0	0	0	0	0	0	0	0

Table 40. MPU register map and reset values (continued)

Offset	Register	31	30	29	28	27	26	25	24	23	22	21	20	19	18	17	16	15	14	13	12	11	10	9	8	7	6	5	4	3	2	1	0
0x10	MPU_RASR	Res.		XN	Reserved	AP[2:0]	Reserved	TEX [2:0]	S	C	B	SRD[7:0]							Reserved	SIZE			EN	ABLE									
	Reset Value	0	0	0	0	0	0	0	0	0	0	0	0	0	0	0	0	0	0	0	0	0	0	0	0	0	0	0	0	0	0	0	0
0x14	MPU_RBAR_A1 ⁽¹⁾	ADDR[31:N]...															VALID	REGION [3:0]															
	Reset Value	0	0	0	0	0	0	0	0	0	0	0	0	0	0	0	0	0	0	0	0	0	0	0	0	0	0	0	0	0	0	0	
0x18	MPU_RASR_A1 ⁽²⁾	Res.		XN	Reserved	AP[2:0]	Reserved	TEX [2:0]	S	C	B	SRD[7:0]							Reserved	SIZE			EN	ABLE									
	Reset Value	0	0	0	0	0	0	0	0	0	0	0	0	0	0	0	0	0	0	0	0	0	0	0	0	0	0	0	0	0	0	0	
0x1C	MPU_RBAR_A2 ⁽¹⁾	ADDR[31:N]...															VALID	REGION [3:0]															
	Reset Value	0	0	0	0	0	0	0	0	0	0	0	0	0	0	0	0	0	0	0	0	0	0	0	0	0	0	0	0	0	0	0	
0x20	MPU_RASR_A2 ⁽²⁾	Res.		XN	Reserved	AP[2:0]	Reserved	TEX [2:0]	S	C	B	SRD[7:0]							Reserved	SIZE			EN	ABLE									
	Reset Value	0	0	0	0	0	0	0	0	0	0	0	0	0	0	0	0	0	0	0	0	0	0	0	0	0	0	0	0	0	0	0	
0x1C	MPU_RBAR_A3 ⁽¹⁾	ADDR[31:N]...															VALID	REGION [3:0]															
	Reset Value	0	0	0	0	0	0	0	0	0	0	0	0	0	0	0	0	0	0	0	0	0	0	0	0	0	0	0	0	0	0	0	
0x20	MPU_RASR_A3 ⁽²⁾	Res.		XN	Reserved	AP[2:0]	Reserved	TEX [2:0]	S	C	B	SRD[7:0]							Reserved	SIZE			EN	ABLE									
	Reset Value	0	0	0	0	0	0	0	0	0	0	0	0	0	0	0	0	0	0	0	0	0	0	0	0	0	0	0	0	0	0	0	

1. Alias of MPU_RBAR register
2. Alias of MPU_RASR register

4.3 Nested vectored interrupt controller (NVIC)

This section describes the Nested Vectored Interrupt Controller (NVIC) and the registers it uses. The NVIC supports:

- up to 81 interrupts (depends on the STM32 device type, refer to the datasheets)
- A programmable priority level of 0-15 for each interrupt. A higher level corresponds to a lower priority, so level 0 is the highest interrupt priority
- Level and pulse detection of interrupt signals
- Dynamic reprioritization of interrupts
- Grouping of priority values into group priority and subpriority fields
- Interrupt tail-chaining
- An external *Non-maskable interrupt* (NMI)

The processor automatically stacks its state on exception entry and unstacks this state on exception exit, with no instruction overhead. This provides low latency exception handling. The hardware implementation of the NVIC registers is:

4.3.1 The CMSIS mapping of the Cortex-M3 NVIC registers

To improve software efficiency, the CMSIS simplifies the NVIC register presentation. In the CMSIS:

- The Set-enable, Clear-enable, Set-pending, Clear-pending and Active Bit registers map to arrays of 32-bit integers, so that:
 - The array ISER[0] to ISER[2] corresponds to the registers ISER0-ISER2
 - The array ICER[0] to ICER[2] corresponds to the registers ICER0-ICER2
 - The array ISPR[0] to ISPR[2] corresponds to the registers ISPR0-ISPR2
 - The array ICPR[0] to ICPR[2] corresponds to the registers ICPR0-ICPR2
 - The array IABR[0] to IABR[2] corresponds to the registers IABR0-IABR2.
- The 8-bit fields of the Interrupt Priority Registers map to an array of 8-bit integers, so that the array IP[0] to IP[67] corresponds to the registers IPR0-IPR67, and the array entry IP[n] holds the interrupt priority for interrupt *n*.

The CMSIS provides thread-safe code that gives atomic access to the Interrupt Priority Registers. For more information see the description of the NVIC_SetPriority function in [NVIC programming hints on page 127](#). [Table 41](#) shows how the interrupts, or IRQ numbers, map onto the interrupt registers and corresponding CMSIS variables that have one bit per interrupt.

Table 41. Mapping of interrupts to the interrupt variables

Interrupts	CMSIS array elements ⁽¹⁾				
	Set-enable	Clear-enable	Set-pending	Clear-pending	Active Bit
0-31	ISER[0]	ICER[0]	ISPR[0]	ICPR[0]	IABR[0]
32-63	ISER[1]	ICER[1]	ISPR[1]	ICPR[1]	IABR[1]
64-67	ISER[2]	ICER[2]	ISPR[2]	ICPR[2]	IABR[2]

1. Each array element corresponds to a single NVIC register, for example the element ICER[1] corresponds to the ICER1 register.

4.3.2 Interrupt set-enable registers (NVIC_ISERx)

Address offset: 0x00 - 0x0B

Reset value: 0x0000 0000

Required privilege: Privileged

31	30	29	28	27	26	25	24	23	22	21	20	19	18	17	16
SETENA[31:16]															
rs	rs	rs	rs	rs	rs	rs	rs	rs	rs	rs	rs	rs	rs	rs	rs
15	14	13	12	11	10	9	8	7	6	5	4	3	2	1	0
SETENA[15:0]															
rs	rs	rs	rs	rs	rs	rs	rs	rs	rs	rs	rs	rs	rs	rs	rs

Bits 31:0 **SETENA[31:0]**: Interrupt set-enable bits.

Write:

- 0: No effect
- 1: Enable interrupt

Read:

- 0: Interrupt disabled
- 1: Interrupt enabled.

See [Table 41: Mapping of interrupts to the interrupt variables on page 119](#) for the correspondence of interrupts to each register bit.

If a pending interrupt is enabled, the NVIC activates the interrupt based on its priority. If an interrupt is not enabled, asserting its interrupt signal changes the interrupt state to pending, but the NVIC never activates the interrupt, regardless of its priority.

4.3.3 Interrupt clear-enable registers (NVIC_ICERx)

Address offset: 0x00 - 0x0B

Reset value: 0x0000 0000

Required privilege: Privileged

The ICER0-ICER2 registers disable interrupts, and show which interrupts are enabled.

31	30	29	28	27	26	25	24	23	22	21	20	19	18	17	16
CLRENA[31:16]															
rc_w1	rc_w1	rc_w1	rc_w1	rc_w1	rc_w1	rc_w1	rc_w1	rc_w1	rc_w1	rc_w1	rc_w1	rc_w1	rc_w1	rc_w1	rc_w1
15	14	13	12	11	10	9	8	7	6	5	4	3	2	1	0
CLRENA[15:0]															
rc_w1	rc_w1	rc_w1	rc_w1	rc_w1	rc_w1	rc_w1	rc_w1	rc_w1	rc_w1	rc_w1	rc_w1	rc_w1	rc_w1	rc_w1	rc_w1

Bits 31:0 **CLRENA[31:0]**: Interrupt clear-enable bits.

Write:

- 0: No effect
- 1: Disable interrupt

Read:

- 0: Interrupt disabled
- 1: Interrupt enabled.

See [Table 41: Mapping of interrupts to the interrupt variables on page 119](#) for the correspondence of interrupts to each register bit.

4.3.4 Interrupt set-pending registers (NVIC_ISPRx)

Address offset: 0x00 - 0x0B

Reset value: 0x0000 0000

Required privilege: Privileged

The ISPR0-ISPR2 registers force interrupts into the pending state, and show which interrupts are pending.

31	30	29	28	27	26	25	24	23	22	21	20	19	18	17	16
SETPEND[31:16]															
rs	rs	rs	rs	rs	rs	rs	rs	rs	rs	rs	rs	rs	rs	rs	rs
15	14	13	12	11	10	9	8	7	6	5	4	3	2	1	0
SETPEND[15:0]															
rs	rs	rs	rs	rs	rs	rs	rs	rs	rs	rs	rs	rs	rs	rs	rs

Bits 31:0 **SETPEND[31:0]**: Interrupt set-pending bits

Write:

- 0: No effect
- 1: Changes interrupt state to pending

Read:

- 0: Interrupt is not pending
- 1: Interrupt is pending

See [Table 41: Mapping of interrupts to the interrupt variables on page 119](#) for the correspondence of interrupts to each register bit.

Writing 1 to the ISPR bit corresponding to an interrupt that is pending:

- has no effect.

Writing 1 to the ISPR bit corresponding to a disabled interrupt:

- sets the state of that interrupt to pending.

4.3.5 Interrupt clear-pending registers (NVIC_ICPRx)

Address offset: 0x00 - 0x0B

Reset value: 0x0000 0000

Required privilege: Privileged

The ICPR0-ICPR2 registers remove the pending state from interrupts, and show which interrupts are pending.

31	30	29	28	27	26	25	24	23	22	21	20	19	18	17	16
CLRPEND[31:16]															
rc_w1	rc_w1	rc_w1	rc_w1	rc_w1	rc_w1	rc_w1	rc_w1	rc_w1	rc_w1	rc_w1	rc_w1	rc_w1	rc_w1	rc_w1	rc_w1
15	14	13	12	11	10	9	8	7	6	5	4	3	2	1	0
CLRPEND[15:0]															
rc_w1	rc_w1	rc_w1	rc_w1	rc_w1	rc_w1	rc_w1	rc_w1	rc_w1	rc_w1	rc_w1	rc_w1	rc_w1	rc_w1	rc_w1	rc_w1

Bits 31:0 **CLRPEND[31:0]**: Interrupt clear-pending bits

Write:

- 0: No effect
- 1: Removes the pending state of an interrupt

Read:

- 0: Interrupt is not pending
- 1: Interrupt is pending

See [Table 41: Mapping of interrupts to the interrupt variables on page 119](#) for the correspondence of interrupts to each register bit.

Writing 1 to an ICPR bit does not affect the active state of the corresponding interrupt.

4.3.6 Interrupt active bit registers (NVIC_IABRx)

Address offset: 0x00- 0x0B

Reset value: 0x0000 0000

Required privilege: Privileged

The IABR0-IABR2 registers indicate which interrupts are active.

The bit assignments are:

31	30	29	28	27	26	25	24	23	22	21	20	19	18	17	16
ACTIVE[31:16]															
r	r	r	r	r	r	r	r	r	r	r	r	r	r	r	r
15	14	13	12	11	10	9	8	7	6	5	4	3	2	1	0
ACTIVE[15:0]															
r	r	r	r	r	r	r	r	r	r	r	r	r	r	r	r

Bits 31:0 **ACTIVE[31:0]**: Interrupt active flags

0: Interrupt not active

1: Interrupt active

See [Table 41: Mapping of interrupts to the interrupt variables on page 119](#) for the correspondence of interrupts to each register bit.

A bit reads as 1 if the status of the corresponding interrupt is active or active and pending.

4.3.7 Interrupt priority registers (NVIC_IPRx)

Address offset: 0x00- 0x0B

Reset value: 0x0000 0000

Required privilege: Privileged

The IPR0-IPR16 registers provide a 4-bit priority field for each interrupt. These registers are byte-accessible. Each register holds four priority fields, that map to four elements in the CMSIS interrupt priority array IP[0] to IP[67], as shown in [Figure 19](#).

Figure 19. NVIC_IPRx register mapping

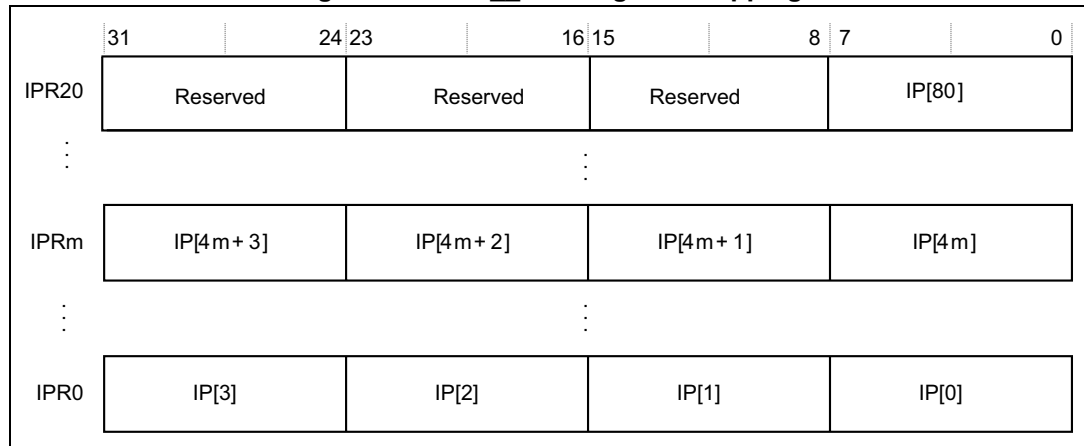

Table 42. IPR bit assignments

Bits	Name	Function
[31:24]	Priority, byte offset 3	Each priority field holds a priority value, 0-255. The lower the value, the greater the priority of the corresponding interrupt. The processor implements only bits[7:4] of each field, bits[3:0] read as zero and ignore writes.
[23:16]	Priority, byte offset 2	
[15:8]	Priority, byte offset 1	
[7:0]	Priority, byte offset 0	

See [The CMSIS mapping of the Cortex-M3 NVIC registers on page 119](#) for more information about the IP[0] to IP[67] interrupt priority array, that provides the software view of the interrupt priorities.

Find the IPR number and byte offset for interrupt *N* as follows:

- The corresponding IPR number, *M*, is given by $M = N \text{ DIV } 4$
- The byte offset of the required Priority field in this register is $N \text{ MOD } 4$, where:
 - byte offset 0 refers to register bits[7:0]
 - byte offset 1 refers to register bits[15:8]
 - byte offset 2 refers to register bits[23:16]
 - byte offset 3 refers to register bits[31:24].

4.3.8 Software trigger interrupt register (NVIC_STIR)

Address offset: 0xE00

Reset value: 0x0000 0000

Required privilege: When the USERSETMPEND bit in the SCR is set to 1, unprivileged software can access the STIR, see [Section 4.4.6: System control register \(SCB_SCR\)](#). Only privileged software can enable unprivileged access to the STIR.

31	30	29	28	27	26	25	24	23	22	21	20	19	18	17	16
Reserved															
15	14	13	12	11	10	9	8	7	6	5	4	3	2	1	0
Reserved							INTID[8:0]								
							w	w	w	w	w	w	w	w	w

Bits 31:9 Reserved, must be kept cleared.

NTID[8:0] Software generated interrupt ID

Bits 8:0 Write to the STIR to generate a Software Generated Interrupt (SGI). The value to be written is the Interrupt ID of the required SGI, in the range 0-239. For example, a value of 0b000000011 specifies interrupt IRQ3.

4.3.9 Level-sensitive and pulse interrupts

STM32 interrupts are both level-sensitive and pulse-sensitive. Pulse interrupts are also described as edge-triggered interrupts.

A level-sensitive interrupt is held asserted until the peripheral deasserts the interrupt signal. Typically this happens because the ISR accesses the peripheral, causing it to clear the interrupt request. A pulse interrupt is an interrupt signal sampled synchronously on the rising edge of the processor clock. To ensure the NVIC detects the interrupt, the peripheral must assert the interrupt signal for at least one clock cycle, during which the NVIC detects the pulse and latches the interrupt.

When the processor enters the ISR, it automatically removes the pending state from the interrupt, see [Hardware and software control of interrupts](#). For a level-sensitive interrupt, if the signal is not deasserted before the processor returns from the ISR, the interrupt becomes pending again, and the processor must execute its ISR again. This means that the peripheral can hold the interrupt signal asserted until it no longer needs servicing.

Hardware and software control of interrupts

The Cortex-M3 latches all interrupts. A peripheral interrupt becomes pending for one of the following reasons:

- The NVIC detects that the interrupt signal is HIGH and the interrupt is not active
- The NVIC detects a rising edge on the interrupt signal
- Software writes to the corresponding interrupt set-pending register bit, see [Section 4.3.4: Interrupt set-pending registers \(NVIC_ISPRx\)](#), or to the STIR to make an SGI pending, see [Section 4.3.8: Software trigger interrupt register \(NVIC_STIR\)](#).

A pending interrupt remains pending until one of the following:

- The processor enters the ISR for the interrupt. This changes the state of the interrupt from pending to active. Then:
 - For a level-sensitive interrupt, when the processor returns from the ISR, the NVIC samples the interrupt signal. If the signal is asserted, the state of the interrupt changes to pending, which might cause the processor to immediately re-enter the ISR. Otherwise, the state of the interrupt changes to inactive.
 - For a pulse interrupt, the NVIC continues to monitor the interrupt signal, and if this is pulsed the state of the interrupt changes to pending and active. In this case, when the processor returns from the ISR the state of the interrupt changes to pending, which might cause the processor to immediately re-enter the ISR. If the interrupt signal is not pulsed while the processor is in the ISR, when the processor returns from the ISR the state of the interrupt changes to inactive.
- Software writes to the corresponding interrupt clear-pending register bit.
 - For a level-sensitive interrupt, if the interrupt signal is still asserted, the state of the interrupt does not change. Otherwise, the state of the interrupt changes to inactive.
 - For a pulse interrupt, state of the interrupt changes to:
 - Inactive, if the state was pending
 - Active, if the state was active and pending.

4.3.10 NVIC design hints and tips

Ensure software uses correctly aligned register accesses. The processor does not support unaligned accesses to NVIC registers. See the individual register descriptions for the supported access sizes.

A interrupt can enter pending state even it is disabled.

Before programming VTOR to relocate the vector table, ensure the vector table entries of the new vector table are setup for fault handlers, NMI and all enabled exception like interrupts. For more information see [Section 4.4.4: Vector table offset register \(SCB_VTOR\) on page 133](#).

NVIC programming hints

Software uses the CPSIE I and CPSID I instructions to enable and disable interrupts. The CMSIS provides the following intrinsic functions for these instructions:

```
void __disable_irq(void) // Disable Interrupts
void __enable_irq(void) // Enable Interrupts
```

In addition, the CMSIS provides a number of functions for NVIC control, including:

Table 43. CMSIS functions for NVIC control

CMSIS interrupt control function	Description
void NVIC_SetPriorityGrouping(uint32_t priority_grouping)	Set the priority grouping
void NVIC_EnableIRQ(IRQn_t IRQn)	Enable IRQn
void NVIC_DisableIRQ(IRQn_t IRQn)	Disable IRQn
uint32_t NVIC_GetPendingIRQ (IRQn_t IRQn)	Return true (IRQ-Number) if IRQn is pending

Table 43. CMSIS functions for NVIC control (continued)

CMSIS interrupt control function	Description
void NVIC_SetPendingIRQ (IRQn_t IRQn)	Set IRQn pending
void NVIC_ClearPendingIRQ (IRQn_t IRQn)	Clear IRQn pending status
uint32_t NVIC_GetActive (IRQn_t IRQn)	Return the IRQ number of the active interrupt
void NVIC_SetPriority (IRQn_t IRQn, uint32_t priority)	Set priority for IRQn
uint32_t NVIC_GetPriority (IRQn_t IRQn)	Read priority of IRQn
void NVIC_SystemReset (void)	Reset the system

For more information about these functions see the CMSIS documentation.

4.3.11 NVIC register map

The table provides shows the NVIC register map and reset values. The base address of the main NVIC register block is 0xE00E100. The NVIC_STIR register is located in a separate block at 0xE00EF00.

Table 44. NVIC register map and reset values

Offset	Register	31	30	29	28	27	26	25	24	23	22	21	20	19	18	17	16	15	14	13	12	11	10	9	8	7	6	5	4	3	2	1	0
0x000	NVIC_ISER0	SETENA[31:0]																															
	Reset Value	0	0	0	0	0	0	0	0	0	0	0	0	0	0	0	0	0	0	0	0	0	0	0	0	0	0	0	0	0	0	0	0
0x004	NVIC_ISER1	SETENA[63:32]																															
	Reset Value	0	0	0	0	0	0	0	0	0	0	0	0	0	0	0	0	0	0	0	0	0	0	0	0	0	0	0	0	0	0	0	0
0x008	NVIC_ISER2	Reserved															SETENA [80:64]																
	Reset Value																0	0	0	0	0	0	0	0	0	0	0	0	0	0	0	0	
0x080	NVIC_ICER0	CLRENA[31:0]																															
	Reset Value	0	0	0	0	0	0	0	0	0	0	0	0	0	0	0	0	0	0	0	0	0	0	0	0	0	0	0	0	0	0	0	0
0x084	NVIC_ICER1	CLRENA[63:32]																															
	Reset Value	0	0	0	0	0	0	0	0	0	0	0	0	0	0	0	0	0	0	0	0	0	0	0	0	0	0	0	0	0	0	0	0
0x088	NVIC_ICER2	Reserved															CLRENA [80:64]																
	Reset Value																0	0	0	0	0	0	0	0	0	0	0	0	0	0	0	0	
0x100	NVIC_ISPR0	SETPEND[31:0]																															
	Reset Value	0	0	0	0	0	0	0	0	0	0	0	0	0	0	0	0	0	0	0	0	0	0	0	0	0	0	0	0	0	0	0	0
0x104	NVIC_ISPR1	SETPEND[63:32]																															
	Reset Value	0	0	0	0	0	0	0	0	0	0	0	0	0	0	0	0	0	0	0	0	0	0	0	0	0	0	0	0	0	0	0	0
0x108	NVIC_ISPR2	Reserved															SETPEND [80:64]																
	Reset Value																0	0	0	0	0	0	0	0	0	0	0	0	0	0	0	0	0
0x180	NVIC_ICPR0	CLRPEND[31:0]																															
	Reset Value	0	0	0	0	0	0	0	0	0	0	0	0	0	0	0	0	0	0	0	0	0	0	0	0	0	0	0	0	0	0	0	0
0x184	NVIC_ICPR1	CLRPEND[63:32]																															
	Reset Value	0	0	0	0	0	0	0	0	0	0	0	0	0	0	0	0	0	0	0	0	0	0	0	0	0	0	0	0	0	0	0	0
0x188	NVIC_ICPR2	Reserved															CLRPEND [80:64]																
	Reset Value																0	0	0	0	0	0	0	0	0	0	0	0	0	0	0	0	0
0x200	NVIC_IABR0	ACTIVE[31:0]																															
	Reset Value	0	0	0	0	0	0	0	0	0	0	0	0	0	0	0	0	0	0	0	0	0	0	0	0	0	0	0	0	0	0	0	0

Table 44. NVIC register map and reset values (continued)

Offset	Register	31	30	29	28	27	26	25	24	23	22	21	20	19	18	17	16	15	14	13	12	11	10	9	8	7	6	5	4	3	2	1	0																					
0x204	NVIC_IABR1	ACTIVE[63:32]																																																				
	Reset Value	0	0	0	0	0	0	0	0	0	0	0	0	0	0	0	0	0	0	0	0	0	0	0	0	0	0	0	0	0	0	0	0	0																				
0x208	NVIC_IABR2	Reserved																ACTIVE [80:64]																																				
	Reset Value																0	0	0	0	0	0	0	0	0	0	0	0	0	0	0	0	0																					
0x300	NVIC_IPR0	IP[3]								IP[2]								IP[1]								IP[0]																												
	Reset Value	0	0	0	0	0	0	0	0	0	0	0	0	0	0	0	0	0	0	0	0	0	0	0	0	0	0	0	0	0	0	0	0																					
:	:	:																																																				
0x320	NVIC_IPR20	Reserved																								IP[80]																												
	Reset Value	0	0	0	0	0	0	0	0	0	0	0	0	0	0	0	0	0	0	0	0	0	0	0	0	0	0	0	0	0	0	0																						
SCB registers																																																						
Reserved																																																						
0xE00	NVIC_STIR	Reserved																								INTID[8:0]																												
	Reset Value																									0	0	0	0	0	0	0	0	0	0	0	0	0	0	0	0	0	0	0	0	0	0	0	0	0	0	0	0	0

4.4 System control block (SCB)

The *System control block* (SCB) provides system implementation information, and system control. This includes configuration, control, and reporting of the system exceptions. The CMSIS mapping of the Cortex-M3 SCB registers

To improve software efficiency, the CMSIS simplifies the SCB register presentation. In the CMSIS, the byte array SHP[0] to SHP[12] corresponds to the registers SHPR1-SHPR3.

4.4.1 Auxiliary control register (SCB_ACTLR)

Address offset: 0x00 (base address = 0xE000 E008)

Reset value: 0x0000 0000

Required privilege: Privileged

The ACTLR register disables certain aspects of functionality within the processor. This register is available in STM32F2 and STM32L series.

31	30	29	28	27	26	25	24	23	22	21	20	19	18	17	16
Reserved															
15	14	13	12	11	10	9	8	7	6	5	4	3	2	1	0
Reserved													DISF OLD	DISD EFW BUF	DISM CYC INT
													rw	rw	rw

Bits 31:3 Reserved, must be kept cleared

Bit 2 DISFOLD

Disables folding of IT instructions:

0: Enables IT instructions folding.

1: Disables IT instructions folding.

Bit 1 DISDEFWBUF

Disables write buffer use during default memory map accesses:

0: Enable write buffer use: stores to memory is competed before next instruction.

1: Disable write buffer use.

Bit 0 DISMCYCINT

Disables interrupt of multi-cycle instructions:

0: Enable interruption latency of the processor (load/store and multiply/divide operations).

1: Disable interruptions latency.

4.4.2 CPUID base register (SCB_CPUID)

Address offset: 0x00

Reset value: 0x411F C231 (STM32F1 series)

Reset value: 0x412F C230 (STM32F2 and STM32L series)

Required privilege: Privileged

The CPUID register contains the processor part number, version, and implementation information.

31	30	29	28	27	26	25	24	23	22	21	20	19	18	17	16
Implementer								Variant				Constant			
r	r	r	r	r	r	r	r	r	r	r	r	r	r	r	r
15	14	13	12	11	10	9	8	7	6	5	4	3	2	1	0
PartNo												Revision			
r	r	r	r	r	r	r	r	r	r	r	r	r	r	r	r

Bits 31:24 **Implementer**: Implementer code

0x41: ARM

Bits 23:20 **Variant**: Variant number

The r value in the *rnpn* product revision identifier

0x1: r1

0x2: r2

Bits 19:16 **Constant**: Reads as 0xF

Bits 15:4 **PartNo**: Part number of the processor

0xC23: = Cortex-M3

Bits 3:0 **Revision**: Revision number

The p value in the *rnpn* product revision identifier, indicates patch release.

0x0: = p0

0x1: = p1

4.4.3 Interrupt control and state register (SCB_ICSR)

Address offset: 0x04

Reset value: 0x0000 0000

Required privilege: Privileged

The ICSR:

- Provides:
 - A set-pending bit for the *Non-Maskable Interrupt* (NMI) exception
 - Set-pending and clear-pending bits for the PendSV and SysTick exceptions
- Indicates:
 - The exception number of the exception being processed
 - Whether there are preempted active exceptions
 - The exception number of the highest priority pending exception
 - Whether any interrupts are pending.

Caution: When you write to the ICSR, the effect is unpredictable if you:

- Write 1 to the PENDSVSET bit and write 1 to the PENDSVCLR bit
- Write 1 to the PENDSTSET bit and write 1 to the PENDSTCLR bit.

	31	30	29	28	27	26	25	24	23	22	21	20	19	18	17	16	
	NMIPE NDSET	Reserved			PEND SVSET	PEND SVCLR	PEND STSET	PENDS TCLR	Reserved		ISRPE NDING	VECTPENDING[9:4]					
	rw				rw	w	rw	w			r	r	r	r	r	r	r
	15	14	13	12	11	10	9	8	7	6	5	4	3	2	1	0	
	VECTPENDING[3:0]				RETOB ASE	Reserved		VECTACTIVE[8:0]									
	r	r	r	r	r			rw	rw	rw	rw	rw	rw	rw	rw	rw	rw

Bit 31 **NMIPENDSET**: NMI set-pending bit.

Write:

- 0: No effect
- 1: Change NMI exception state to pending.

Read:

- 0: NMI exception is not pending
- 1: NMI exception is pending

Because NMI is the highest-priority exception, normally the processor enters the NMI exception handler as soon as it registers a write of 1 to this bit, and entering the handler clears this bit to 0. A read of this bit by the NMI exception handler returns 1 only if the NMI signal is reasserted while the processor is executing that handler.

Bits 30:29 Reserved, must be kept cleared

Bit 28 **PENDSVSET**: PendSV set-pending bit.

Write:

- 0: No effect
- 1: Change PendSV exception state to pending.

Read:

- 0: PendSV exception is not pending
- 1: PendSV exception is pending

Writing 1 to this bit is the only way to set the PendSV exception state to pending.

Bit 27 **PENDSVCLR**: PendSV clear-pending bit.

Write:

- 0: No effect
- 1: Removes the pending state from the PendSV exception.

Bit 26 **PENDSTSET**: SysTick exception set-pending bit.

Write:

- 0: No effect
- 1: Change SysTick exception state to pending

Read:

- 0: SysTick exception is not pending
- 1: SysTick exception is pending

Bit 25 **PENDSTCLR**: SysTick exception clear-pending bit.

Write:

- 0: No effect
- 1: Removes the pending state from the SysTick exception.

This bit is write-only. On a register read its value is unknown.

Bit 24 Reserved, must be kept cleared.

Bit 23 This bit is reserved for Debug use and reads-as-zero when the processor is not in Debug.

Bit 22 **ISR_PENDING**: Interrupt pending flag, excluding NMI and Faults

- 0: Interrupt not pending
- 1: Interrupt pending

Bits 21:12 VECTPENDING[9:0] Pending vector

Indicates the exception number of the highest priority pending enabled exception.

0: No pending exceptions

Other values: The exception number of the highest priority pending enabled exception.

The value indicated by this field includes the effect of the BASEPRI and FAULTMASK registers, but not any effect of the PRIMASK register.

Bit 11 **RETOBASE**: Return to base level

Indicates whether there are preempted active exceptions:

0: There are preempted active exceptions to execute

1: There are no active exceptions, or the currently-executing exception is the only active exception.

Bits 10:9 Reserved, must be kept cleared

Bits 8:0 VECTACTIVE[8:0] Active vector

Contains the active exception number:

0: Thread mode

Other values: The exception number⁽¹⁾ of the currently active exception.

Note: Subtract 16 from this value to obtain the IRQ number required to index into the Interrupt Clear-Enable, Set-Enable, Clear-Pending, Set-Pending, or Priority Registers, see Table 5 on page 18.

1. This is the same value as IPSR bits[8:0], see [Interrupt program status register on page 18](#).

4.4.4 Vector table offset register (SCB_VTOR)

Address offset: 0x08

Reset value: 0x0000 0000

Required privilege: Privileged

31	30	29	28	27	26	25	24	23	22	21	20	19	18	17	16
Reserved		TBLOFF[29:16]													
		rw	rw	rw	rw	rw	rw	rw	rw	rw	rw	rw	rw	rw	rw
15	14	13	12	11	10	9	8	7	6	5	4	3	2	1	0
TBLOFF[15:9]							Reserved								
		rw	rw	rw	rw	rw									

Bits 31:30 Reserved, must be kept cleared

Bits 29:9 **TBLOFF[29:9]**: Vector table base offset field.

It contains bits [29:9] of the offset of the table base from memory address 0x00000000. When setting TBLOFF, you must align the offset to the number of exception entries in the vector table. The minimum alignment is 128 words. Table alignment requirements mean that bits[8:0] of the table offset are always zero.

Bit 29 determines whether the vector table is in the code or SRAM memory region.

0: Code

1: SRAM

Note: Bit 29 is sometimes called the TBLBASE bit.

Bits 8:0 Reserved, must be kept cleared

4.4.5 Application interrupt and reset control register (SCB_AIRCR)

Address offset: 0x0C

Reset value: 0xFA05 0000

Required privilege: Privileged

The AIRCR provides priority grouping control for the exception model, endian status for data accesses, and reset control of the system.

To write to this register, you must write 0x5FA to the VECTKEY field, otherwise the processor ignores the write.

31	30	29	28	27	26	25	24	23	22	21	20	19	18	17	16	
VECTKEYSTAT[15:0](read)/ VECTKEY[15:0](write)																
rw	rw	rw	rw	rw	rw	rw	rw	rw	rw	rw	rw	rw	rw	rw	rw	
15	14	13	12	11	10	9	8	7	6	5	4	3	2	1	0	
ENDIANESS	Reserved				PRIGROUP			Reserved						SYS RESET REQ	VECT CLR ACTIVE	VECT RESET
r					rw	rw	rw							w	w	w

Bits 31:16 **VECTKEYSTAT[15:0]/ VECTKEY[15:0]** Register key

Reads as 0xFA05

On writes, write 0x5FA to VECTKEY, otherwise the write is ignored.

Bit 15 **ENDIANESS** Data endianness bit

Reads as 0.

0: Little-endian

Bits 14:11 Reserved, must be kept cleared

Bits 10:8 **PRIGROUP[2:0]**: Interrupt priority grouping field

This field determines the split of group priority from subpriority, see [Binary point on page 135](#).

Bits 7:3 Reserved, must be kept cleared

Bit 2 SYSRESETREQ System reset request

This is intended to force a large system reset of all major components except for debug.

This bit reads as 0.

0: No system reset request

1: Asserts a signal to the outer system that requests a reset.

Bit 1 VECTCLRACTIVE

Reserved for Debug use. This bit reads as 0. When writing to the register you must write 0 to this bit, otherwise behavior is unpredictable.

Bit 0 VECTRESET

Reserved for Debug use. This bit reads as 0. When writing to the register you must write 0 to this bit, otherwise behavior is unpredictable.

Binary point

The PRIGROUP field indicates the position of the binary point that splits the PRI_n fields in the Interrupt Priority Registers into separate *group priority* and *subpriority* fields. [Table 45](#) shows how the PRIGROUP value controls this split.

Table 45. Priority grouping

PRIGROUP [2:0]	Interrupt priority level value, $PRI_N[7:4]$			Number of	
	Binary point ⁽¹⁾	Group priority bits	Subpriority bits	Group priorities	Sub priorities
0b011	0bxxxx	[7:4]	None	16	None
0b100	0bxxx.y	[7:5]	[4]	8	2
0b101	0bxx.yy	[7:6]	[5:4]	4	4
0b110	0bx.yyy	[7]	[6:4]	2	8
0b111	0b.yyyy	None	[7:4]	None	16

1. $PRI_n[7:4]$ field showing the binary point. x denotes a group priority field bit, and y denotes a subpriority field bit.

Determining preemption of an exception uses only the group priority field, see [Section 2.3.6: Interrupt priority grouping on page 37](#).

4.4.6 System control register (SCB_SCR)

Address offset: 0x10

Reset value: 0x0000 0000

Required privilege: Privileged

The SCR controls features of entry to and exit from low power state.

31	30	29	28	27	26	25	24	23	22	21	20	19	18	17	16
Reserved															
15	14	13	12	11	10	9	8	7	6	5	4	3	2	1	0
Reserved											SEVON PEND	Res.	SLEEP DEEP	SLEEP ON EXIT	Res.
											rw		rw	rw	

Bits 31:5 Reserved, must be kept cleared

Bit 4 SEVONPEND Send Event on Pending bit

When an event or interrupt enters pending state, the event signal wakes up the processor from WFE. If the processor is not waiting for an event, the event is registered and affects the next WFE.

The processor also wakes up on execution of an SEV instruction or an external event

0: Only enabled interrupts or events can wakeup the processor, disabled interrupts are excluded

1: Enabled events and all interrupts, including disabled interrupts, can wakeup the processor.

Bit 3 Reserved, must be kept cleared

Bit 2 SLEEPDEEP

Controls whether the processor uses sleep or deep sleep as its low power mode:

0: Sleep

1: Deep sleep.

Bit 1 SLEEPONEXIT

Configures sleep-on-exit when returning from Handler mode to Thread mode. Setting this bit to 1 enables an interrupt-driven application to avoid returning to an empty main application.

0: Do not sleep when returning to Thread mode.

1: Enter sleep, or deep sleep, on return from an interrupt service routine.

Bit 0 Reserved, must be kept cleared

4.4.7 Configuration and control register (SCB_CCR)

Address offset: 0x14

Reset value: 0x0000 0200 (STM32F2 and STM32L series)

Reset value: 0x0000 0000 (STM32F1 series)

Required privilege: Privileged

The CCR controls entry to Thread mode and enables:

- The handlers for NMI, hard fault and faults escalated by FAULTMASK to ignore bus faults
- Trapping of divide by zero and unaligned accesses
- Access to the STIR by unprivileged software, see [Software trigger interrupt register \(NVIC_STIR\) on page 126](#).

31	30	29	28	27	26	25	24	23	22	21	20	19	18	17	16	
Reserved																
15	14	13	12	11	10	9	8	7	6	5	4	3	2	1	0	
Reserved						STK ALIGN	BFHF NMIGN	Reserved				DIV_0_ TRP	UN ALIGN_ TRP	Res.	USER SET MPEND	NON BASE THRD ENA
						rw	rw					rw	rw		rw	rw

Bits 31:10 Reserved, must be kept cleared

Bit 9 STKALIGN

Configures stack alignment on exception entry. On exception entry, the processor uses bit 9 of the stacked PSR to indicate the stack alignment. On return from the exception it uses this stacked bit to restore the correct stack alignment.

- 0: 4-byte aligned
- 1: 8-byte aligned

Bit 8 BFHFNMIGN

Enables handlers with priority -1 or -2 to ignore data bus faults caused by load and store instructions. This applies to the hard fault, NMI, and FAULTMASK escalated handlers. Set this bit to 1 only when the handler and its data are in absolutely safe memory. The normal use of this bit is to probe system devices and bridges to detect control path problems and fix them.

- 0: Data bus faults caused by load and store instructions cause a lock-up
- 1: Handlers running at priority -1 and -2 ignore data bus faults caused by load and store instructions.

Bits 7:5 Reserved, must be kept cleared

Bit 4 DIV_0_TRP

Enables faulting or halting when the processor executes an SDIV or UDIV instruction with a divisor of 0:

- 0: Do not trap divide by 0
- 1: Trap divide by 0.

When this bit is set to 0, a divide by zero returns a quotient of 0.

Bit 3 UNALIGN_TRP

Enables unaligned access traps:

- 0: Do not trap unaligned halfword and word accesses
- 1: Trap unaligned halfword and word accesses.

If this bit is set to 1, an unaligned access generates a usage fault.

Unaligned LDM, STM, LDRD, and STRD instructions always fault irrespective of whether UNALIGN_TRP is set to 1.

Bit 2 Reserved, must be kept cleared

Bit 1 USERSETPEND

Enables unprivileged software access to the STIR, see [Software trigger interrupt register \(NVIC_STIR\) on page 126](#):

- 0: Disable
- 1: Enable.

Bit 0 NONBASETHRDENA

Configures how the processor enters Thread mode.

- 0: Processor can enter Thread mode only when no exception is active.
- 1: Processor can enter Thread mode from any level under the control of an EXC_RETURN value, see [Exception return on page 39](#).

4.4.8 System handler priority registers (SHPRx)

The SHPR1-SHPR3 registers set the priority level, 0 to 15 of the exception handlers that have configurable priority.

SHPR1-SHPR3 are byte accessible.

The system fault handlers and the priority field and register for each handler are:

Table 46. System fault handler priority fields

Handler	Field	Register description
Memory management fault	PRI_4	System handler priority register 1 (SCB_SHPR1)
Bus fault	PRI_5	
Usage fault	PRI_6	
SVCall	PRI_11	System handler priority register 2 (SCB_SHPR2) on page 139
PendSV	PRI_14	System handler priority register 3 (SCB_SHPR3) on page 140
SysTick	PRI_15	

Each PRI_N field is 8 bits wide, but the processor implements only bits[7:4] of each field, and bits[3:0] read as zero and ignore writes.

System handler priority register 1 (SCB_SHPR1)

Address offset: 0x18

Reset value: 0x0000 0000

Required privilege: Privileged

31	30	29	28	27	26	25	24	23	22	21	20	19	18	17	16
Reserved								PRI_6[7:4]				PRI_6[3:0]			
								rw	rw	rw	rw	r	r	r	r
15	14	13	12	11	10	9	8	7	6	5	4	3	2	1	0
PRI_5[7:4]				PRI_5[3:0]				PRI_4[7:4]				PRI_4[3:0]			
rw	rw	rw	rw	r	r	r	r	rw	rw	rw	rw	r	r	r	r

Bits 31:24 Reserved, must be kept cleared

Bits 23:16 PRI_6[7:0]: Priority of system handler 6, usage fault

Bits 15:8 PRI_5[7:0]: Priority of system handler 5, bus fault

Bits 7:0 PRI_4[7:0]: Priority of system handler 4, memory management fault

System handler priority register 2 (SCB_SHPR2)

Address offset: 0x1C

Reset value: 0x0000 0000

Required privilege: Privileged

31	30	29	28	27	26	25	24	23	22	21	20	19	18	17	16
PRI_11[7:4]				PRI_11[3:0]				Reserved							
rw	rw	rw	rw	r	r	r	r								
15	14	13	12	11	10	9	8	7	6	5	4	3	2	1	0
Reserved															

Bits 31:24 **PRI_11[7:0]**: Priority of system handler 11, SVCcall

Bits 23:0 Reserved, must be kept cleared

System handler priority register 3 (SCB_SHPR3)

Address: 0xE000 ED20

Reset value: 0x0000 0000

Required privilege: Privileged

31	30	29	28	27	26	25	24	23	22	21	20	19	18	17	16
PRI_15[7:4]				PRI_15[3:0]				PRI_14[7:4]				PRI_14[3:0]			
rw	rw	rw	rw	r	r	r	r	rw	rw	rw	rw	r	r	r	r
15	14	13	12	11	10	9	8	7	6	5	4	3	2	1	0
Reserved															

Bits 31:24 **PRI_15[7:0]**: Priority of system handler 15, SysTick exception

Bits 23:16 **PRI_14[7:0]**: Priority of system handler 14, PendSV

Bits 15:0 Reserved, must be kept cleared

4.4.9 System handler control and state register (SCB_SHCSR)

Address offset: 0x24

Reset value: 0x0000 0000

Required privilege: Privileged

The SHCSR enables the system handlers, and indicates:

- The pending status of the bus fault, memory management fault, and SVC exceptions
- The active status of the system handlers.

If you disable a system handler and the corresponding fault occurs, the processor treats the fault as a hard fault.

You can write to this register to change the pending or active status of system exceptions. An OS kernel can write to the active bits to perform a context switch that changes the current exception type.

- Software that changes the value of an active bit in this register without correct adjustment to the stacked content can cause the processor to generate a fault exception. Ensure software that writes to this register retains and subsequently restores the current active status.
- After you have enabled the system handlers, if you have to change the value of a bit in this register you must use a read-modify-write procedure to ensure that you change only the required bit.

Reserved													USG FAULT ENA	BUS FAULT ENA	MEM FAULT ENA	
Reserved													rw	rw	rw	
31	30	29	28	27	26	25	24	23	22	21	20	19	18	17	16	
15	14	13	12	11	10	9	8	7	6	5	4	3	2	1	0	
SV CALL PEND ED	BUS FAULT PEND ED	MEM FAULT PEND ED	USG FAULT PEND ED	SYS TICK ACT	PEND SV ACT	Res.	MONIT OR ACT	SV CALL ACT	Reserved				USG FAULT ACT	Res.	BUS FAULT ACT	MEM FAULT ACT
rw	rw	rw	rw	rw	rw		rw	rw					rw		rw	rw

Bits 31:19 Reserved, must be kept cleared

Bit 18 **USGFAULTENA**: Usage fault enable bit, set to 1 to enable⁽¹⁾

Bit 17 **BUSFAULTENA**: Bus fault enable bit, set to 1 to enable⁽¹⁾

Bit 16 **MEMFAULTENA**: Memory management fault enable bit, set to 1 to enable⁽¹⁾

Bit 15 **SVCALLPENDEd**: SVC call pending bit, reads as 1 if exception is pending⁽²⁾

Bit 14 **BUSFAULTPENDEd**: Bus fault exception pending bit, reads as 1 if exception is pending⁽²⁾

Bit 13 **MEMFAULTPENDEd**: Memory management fault exception pending bit, reads as 1 if exception is pending⁽²⁾

Bit 12 **USGFAULTPENDEd**: Usage fault exception pending bit, reads as 1 if exception is pending⁽²⁾

Bit 11 **SYSTICKACT**: SysTick exception active bit, reads as 1 if exception is active⁽³⁾

Bit 10 **PENDSVACT**: PendSV exception active bit, reads as 1 if exception is active

Bit 9 Reserved, must be kept cleared

Bit 8 **MONITORACT**: Debug monitor active bit, reads as 1 if Debug monitor is active

Bit 7 **SVCALLACT**: SVC call active bit, reads as 1 if SVC call is active

Bits 6:4 Reserved, must be kept cleared

Bit 3 **USGFAULTACT**: Usage fault exception active bit, reads as 1 if exception is active

Bit 2 Reserved, must be kept cleared

Bit 1 **BUSFAULTACT**: Bus fault exception active bit, reads as 1 if exception is active

Bit 0 **MEMFAULTACT**: Memory management fault exception active bit, reads as 1 if exception is active

1. Enable bits, set to 1 to enable the exception, or set to 0 to disable the exception.
2. Pending bits, read as 1 if the exception is pending, or as 0 if it is not pending. You can write to these bits to change the pending status of the exceptions.
3. Active bits, read as 1 if the exception is active, or as 0 if it is not active. You can write to these bits to change the active status of the exceptions, but see the Caution in this section.

4.4.10 Configurable fault status register (SCB_CFSR)

Address offset: 0x28

Reset value: 0x0000 0000

Required privilege: Privileged

The CFSR is byte accessible. You can access the CFSR or its subregisters as follows:

- Access the complete CFSR with a word access to 0xE000ED28
- Access the MMFSR with a byte access to 0xE000ED28
- Access the MMFSR and BFSR with a halfword access to 0xE000ED28
- Access the BFSR with a byte access to 0xE000ED29
- Access the UFSR with a halfword access to 0xE000ED2A.

The CFSR indicates the cause of a memory management fault, bus fault, or usage fault.

Figure 20. CFSR subregisters

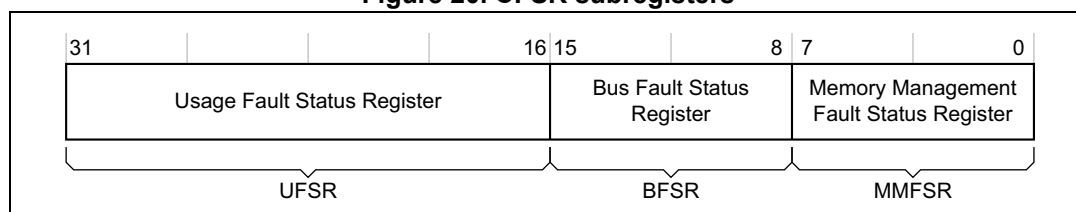

31																16																8																7																0																																																																																																																																																																																															
Reserved																DIVBY ZERO		UNALIGNED		Reserved																NOCP		INVPC		INV STATE		UNDEF INSTR																																																																																																																																																																																																																					
Reserved																rc_w1		rc_w1		Reserved																rc_w1		rc_w1		rc_w1		rc_w1																																																																																																																																																																																																																					
15																14																13																12																11																10																9																8																7																6																5																4																3																2																1																0															
BFARVALID		Reserved														STKERR		UNSTKERR		IMPRECISEERR		PRECISEERR		IBUSERR		MMARVALID		Reserved														MSTKERR		MUNSTKERR		Res.		DACCVIOL		IACCVIOL																																																																																																																																																																																																													
rw																rw		rw		rw		rw		rw																rw		rw				rw		rw																																																																																																																																																																																																															

Bits 31:26 Reserved, must be kept cleared

Bit 25 **DIVBYZERO**: Divide by zero usage fault

When the processor sets this bit to 1, the PC value stacked for the exception return points to the instruction that performed the divide by zero.

Enable trapping of divide by zero by setting the DIV_0_TRP bit in the CCR to 1, see [Configuration and control register \(SCB_CCR\) on page 137](#).

- 0: No divide by zero fault, or divide by zero trapping not enabled
- 1: The processor has executed an SDIV or UDIV instruction with a divisor of 0.

Bit 24 **UNALIGNED**: Unaligned access usage fault:

Enable trapping of unaligned accesses by setting the UNALIGN_TRP bit in the CCR to 1, see [Configuration and control register \(SCB_CCR\) on page 137](#).

Unaligned LDM, STM, LDRD, and STRD instructions always fault irrespective of the setting of UNALIGN_TRP.

- 0: No unaligned access fault, or unaligned access trapping not enabled
- 1: the processor has made an unaligned memory access.

Bits 23:20 Reserved, must be kept cleared

- Bit 19 **NOCP**: No coprocessor usage fault. The processor does not support coprocessor instructions:
- 0: No usage fault caused by attempting to access a coprocessor
 - 1: the processor has attempted to access a coprocessor.
- Bit 18 **INVPC**: Invalid PC load usage fault, caused by an invalid PC load by EXC_RETURN:
- When this bit is set to 1, the PC value stacked for the exception return points to the instruction that tried to perform the illegal load of the PC.
- 0: No invalid PC load usage fault
 - 1: The processor has attempted an illegal load of EXC_RETURN to the PC, as a result of an invalid context, or an invalid EXC_RETURN value.
- Bit 17 **INVSTATE**: Invalid state usage fault:
- When this bit is set to 1, the PC value stacked for the exception return points to the instruction that attempted the illegal use of the EPSR.
- This bit is not set to 1 if an undefined instruction uses the EPSR.
- 0: No invalid state usage fault
 - 1: The processor has attempted to execute an instruction that makes illegal use of the EPSR.
- Bit 16 **UNDEFINSTR**: Undefined instruction usage fault:
- When this bit is set to 1, the PC value stacked for the exception return points to the undefined instruction.
- An undefined instruction is an instruction that the processor cannot decode.
- 0: No undefined instruction usage fault
 - 1: The processor has attempted to execute an undefined instruction.
- Bit 15 **BFARVALID**: *Bus Fault Address Register* (BFAR) valid flag:
- The processor sets this bit to 1 after a bus fault where the address is known. Other faults can set this bit to 0, such as a memory management fault occurring later.
- If a bus fault occurs and is escalated to a hard fault because of priority, the hard fault handler must set this bit to 0. This prevents problems if returning to a stacked active bus fault handler whose BFAR value has been overwritten.
- 0: Value in BFAR is not a valid fault address
 - 1: BFAR holds a valid fault address.
- Bits 14:13 Reserved, must be kept cleared
- Bit 12 **STKERR**: Bus fault on stacking for exception entry
- When the processor sets this bit to 1, the SP is still adjusted but the values in the context area on the stack might be incorrect. The processor does not write a fault address to the BFAR.
- 0: No stacking fault
 - 1: Stacking for an exception entry has caused one or more bus faults.
- Bit 11 **UNSTKERR**: Bus fault on unstacking for a return from exception
- This fault is chained to the handler. This means that when the processor sets this bit to 1, the original return stack is still present. The processor does not adjust the SP from the failing return, does not performed a new save, and does not write a fault address to the BFAR.
- 0: No unstacking fault
 - 1: Unstack for an exception return has caused one or more bus faults.

Bit 10 IMPRECISERR: Imprecise data bus error

When the processor sets this bit to 1, it does not write a fault address to the BFAR.

This is an asynchronous fault. Therefore, if it is detected when the priority of the current process is higher than the bus fault priority, the bus fault becomes pending and becomes active only when the processor returns from all higher priority processes. If a precise fault occurs before the processor enters the handler for the imprecise bus fault, the handler detects both IMPRECISERR set to 1 and one of the precise fault status bits set to 1.

0: No imprecise data bus error

1: A data bus error has occurred, but the return address in the stack frame is not related to the instruction that caused the error.

Bit 9 PRECISERR: Precise data bus error

When the processor sets this bit to 1, it writes the faulting address to the BFAR.

0: No precise data bus error

1: A data bus error has occurred, and the PC value stacked for the exception return points to the instruction that caused the fault.

Bit 8 IBUSERR: Instruction bus error

The processor detects the instruction bus error on prefetching an instruction, but it sets the IBUSERR flag to 1 only if it attempts to issue the faulting instruction.

When the processor sets this bit to 1, it does not write a fault address to the BFAR.

0: No instruction bus error

1: Instruction bus error.

Bit 7 MMARVALID: Memory Management Fault Address Register (MMAR) valid flag

If a memory management fault occurs and is escalated to a hard fault because of priority, the hard fault handler must set this bit to 0. This prevents problems on return to a stacked active memory management fault handler whose MMAR value has been overwritten.

0: Value in MMAR is not a valid fault address

1: MMAR holds a valid fault address.

Bits 6:5 Reserved, must be kept cleared

Bit 4 MSTKERR: Memory manager fault on stacking for exception entry

When this bit is 1, the SP is still adjusted but the values in the context area on the stack might be incorrect. The processor has not written a fault address to the MMAR.

0: No stacking fault

1: Stacking for an exception entry has caused one or more access violations.

Bit 3 MUNSTKERR: Memory manager fault on unstacking for a return from exception

This fault is chained to the handler. This means that when this bit is 1, the original return stack is still present. The processor has not adjusted the SP from the failing return, and has not performed a new save. The processor has not written a fault address to the MMAR.

0: No unstacking fault

1: Unstack for an exception return has caused one or more access violations.

Bit 2 Reserved, must be kept cleared

Bit 1 **DACCVIOL**: Data access violation flag

When this bit is 1, the PC value stacked for the exception return points to the faulting instruction. The processor has loaded the MMAR with the address of the attempted access.

0: No data access violation fault

1: The processor attempted a load or store at a location that does not permit the operation.

Bit 1 **IACCVIOL**: Instruction access violation flag

This fault occurs on any access to an XN region.

When this bit is 1, the PC value stacked for the exception return points to the faulting instruction. The processor has not written a fault address to the MMAR.

0: No instruction access violation fault

1: The processor attempted an instruction fetch from a location that does not permit execution.

4.4.11 Hard fault status register (SCB_HFSR)

Address offset: 0x2C

Reset value: 0x0000 0000

Required privilege: Privileged

The HFSR gives information about events that activate the hard fault handler.

This register is read, write to clear. This means that bits in the register read normally, but writing 1 to any bit clears that bit to 0.

31	30	29	28	27	26	25	24	23	22	21	20	19	18	17	16
DEBU G_VT	FORC ED	Reserved													
rc_w1	rc_w1														
15	14	13	12	11	10	9	8	7	6	5	4	3	2	1	0
Reserved													VECT TBL	Res.	
													rc_w1		

Bit 31 **DEBUG_VT**:

Reserved for Debug use. When writing to the register you must write 0 to this bit, otherwise behavior is unpredictable.

Bit 30 **FORCED**: Forced hard fault

Indicates a forced hard fault, generated by escalation of a fault with configurable priority that cannot be handles, either because of priority or because it is disabled:

When this bit is set to 1, the hard fault handler must read the other fault status registers to find the cause of the fault.

0: No forced hard fault

1: Forced hard fault.

Bits 29:2 Reserved, must be kept cleared

Bit 1 VECTTBL: Vector table hard fault

Indicates a bus fault on a vector table read during exception processing:

This error is always handled by the hard fault handler.

When this bit is set to 1, the PC value stacked for the exception return points to the instruction that was preempted by the exception.

0: No bus fault on vector table read

1: Bus fault on vector table read.

Bit 0 Reserved, must be kept cleared

4.4.12 Memory management fault address register (SCB_MMFAR)

Address offset: 0x34

Reset value: undefined

Required privilege: Privileged

31	30	29	28	27	26	25	24	23	22	21	20	19	18	17	16
MMFAR[31:16]															
rw	rw	rw	rw	rw	rw	rw	rw	rw	rw	rw	rw	rw	rw	rw	rw
15	14	13	12	11	10	9	8	7	6	5	4	3	2	1	0
MMFAR[15:0]															
rw	rw	rw	rw	rw	rw	rw	rw	rw	rw	rw	rw	rw	rw	rw	rw

Bits 31:0 **MMFAR[31:0]**: Memory management fault address

When the MMARVALID bit of the MMFSR is set to 1, this field holds the address of the location that generated the memory management fault.

When an unaligned access faults, the address is the actual address that faulted. Because a single read or write instruction can be split into multiple aligned accesses, the fault address can be any address in the range of the requested access size.

Flags in the MMFSR register indicate the cause of the fault, and whether the value in the MMFAR is valid. See [Configurable fault status register \(SCB_CFSR\) on page 142](#).

4.4.13 Bus fault address register (SCB_BFAR)

Address offset: 0x38

Reset value: undefined

Required privilege: Privileged

31	30	29	28	27	26	25	24	23	22	21	20	19	18	17	16
BFAR[31:16]															
rw	rw	rw	rw	rw	rw	rw	rw	rw	rw	rw	rw	rw	rw	rw	rw
15	14	13	12	11	10	9	8	7	6	5	4	3	2	1	0
BFAR[15:0]															
rw	rw	rw	rw	rw	rw	rw	rw	rw	rw	rw	rw	rw	rw	rw	rw

Bits 31:0 **BFAR[31:0]**: Bus fault address

When the BFARVALID bit of the BFSR is set to 1, this field holds the address of the location that generated the bus fault.

When an unaligned access faults the address in the BFAR is the one requested by the instruction, even if it is not the address of the fault.

Flags in the BFSR register indicate the cause of the fault, and whether the value in the BFAR is valid. See [Configurable fault status register \(SCB_CFSR\) on page 142](#).

4.4.14 System control block design hints and tips

Ensure software uses aligned accesses of the correct size to access the system control block registers:

- except for the CFSR and SHPR1-SHPR3, it must use aligned word accesses
- for the CFSR and SHPR1-SHPR3 it can use byte or aligned halfword or word accesses.

The processor does not support unaligned accesses to system control block registers.

In a fault handler, to determine the true faulting address:

1. Read and save the MMFAR or BFAR value.
2. Read the MMARVALID bit in the MMFSR, or the BFARVALID bit in the BFSR. The MMFAR or BFAR address is valid only if this bit is 1.

Software must follow this sequence because another higher priority exception might change the MMFAR or BFAR value. For example, if a higher priority handler preempts the current fault handler, the other fault might change the MMFAR or BFAR value.

4.4.15 SCB register map

The table provides shows the System control block register map and reset values.

The base address of the SCB register block is 0xE000 ED00 for register described in [Table 48](#).

For STM32L and STM32F2, an auxiliary control register is added with base address of the SCB register block set to 0xE000 E008, see [Table 47](#).

Table 47. SCB register map and reset value for STM32F2 and STM32L

Offset	Register	31	30	29	28	27	26	25	24	23	22	21	20	19	18	17	16	15	14	13	12	11	10	9	8	7	6	5	4	3	2	1	0
0x00	SCB_ACTLR	Implementer				Variant				Constant				PartNo												Revision							
	Reset Value	0	0	0	0	0	0	0	0	0	0	0	0	0	0	0	0	0	0	0	0	0	0	0	0	0	0	0	0	0	0	0	0

Table 48. SCB register map and reset values

Offset	Register	31	30	29	28	27	26	25	24	23	22	21	20	19	18	17	16	15	14	13	12	11	10	9	8	7	6	5	4	3	2	1	0								
0x00	SCB_CPUID	Implementer				Variant				Constant				PartNo								Revision																			
	Reset Value	0	1	0	0	0	0	0	1	0	0	0	1	1	1	1	1	1	1	1	0	0	0	0	1	0	0	0	1	1	0	0	0	1							
0x04	SCB_ICSR	NMIPENDSET	Reserved		PENDSVSET	PENDSVCLR	PENDSTSET	PENDSTCLR	Reserved		ISRSPENDING	VECTPENDING[9:0]										RETOBASE	Reserved		VECTACTIVE[8:0]																
	Reset Value	0			0	0	0	0			0	0										0			0																
0x08	SCB_VTOR	TABLEOFF[29:9]																																							
	Reset Value	Reserved		0																								Reserved													
0x0C	SCB_AIRCR	VECTKEY[15:0]															ENDIANESS	Reserved				PRIGROUP [2:0]	Reserved																		
	Reset Value	1	1	1	1	1	1	0	1	0	0	0	0	0	0	1	0	1	0					0	0	0															
0x10	SCB_SCR	Reserved																																							
	Reset Value																																								
0x14	SCB_CCR	Reserved																																							
	Reset Value (STM32F1 series)																			STKALIGN	BFHFIGN		Res.																		
	Reset Value (STM32F2 and STM32L series)																			0	0			DIV_0_TRP	UNALIGN_TRP	Reserved		USERSETMPEND	NONBASETHRDENA	0		0									
0x18	SCB_SHPR1	Reserved								PRI6				PRI5				PRI4																							
	Reset Value									0				0				0																							
0x1C	SCB_SHPR2	PRI11								Reserved																															
	Reset Value	0																																							
0x20	SCB_SHPR3	PRI15								PRI14				Reserved																											
	Reset Value	0								0																															

Table 48. SCB register map and reset values (continued)

Offset	Register	31	30	29	28	27	26	25	24	23	22	21	20	19	18	17	16	15	14	13	12	11	10	9	8	7	6	5	4	3	2	1	0									
0x24	SCB_SHCRS	Reserved														USG FAULT ENA	BUS FAULT ENA	MEM FAULT ENA	SV CALL PENDED	BUS FAULT PENDED	MEM FAULT PENDED	USG FAULT PENDED	SYS TICK ACT	PENDSV ACT	Reserved	MONITOR ACT	SV CALL ACT	Res.				USG FAULT ACT	Reserved	BUS FAULT ACT	MEM FAULT ACT							
	Reset Value															0	0	0	0	0	0	0	0	0	0	0	0	0	0	0	0	0	0	0	0	0	0	0	0	0	0	0
0x28	SCB_CFSR	UFSR														BFSR						MMFSR																				
	Reset Value	0	0	0	0	0	0	0	0	0	0	0	0	0	0	0	0	0	0	0	0	0	0	0	0	0	0	0	0	0	0	0	0	0								
0x2C	SCB_HFSR	DEBUG_VT	FORCED	Reserved																							VECTBL	Reserved														
	Reset Value	0	0																								0															
0x34	SCB_MMAR	MMAR[31:0]																																								
	Reset Value	x	x	x	x	x	x	x	x	x	x	x	x	x	x	x	x	x	x	x	x	x	x	x	x	x	x	x	x	x	x	x	x									
0x38	SCB_BFAR	BFAR[31:0]																																								
	Reset Value	x	x	x	x	x	x	x	x	x	x	x	x	x	x	x	x	x	x	x	x	x	x	x	x	x	x	x	x	x	x	x	x	x								

4.5 SysTick timer (STK)

The processor has a 24-bit system timer, SysTick, that counts down from the reload value to zero, reloads (wraps to) the value in the LOAD register on the next clock edge, then counts down on subsequent clocks.

When the processor is halted for debugging the counter does not decrement.



4.5.1 SysTick control and status register (STK_CTRL)

Address offset: 0x00

Reset value: 0x0000 0000

Required privilege: Privileged

The SysTick CTRL register enables the SysTick features.

31	30	29	28	27	26	25	24	23	22	21	20	19	18	17	16
Reserved															COUNT FLAG
															rw
15	14	13	12	11	10	9	8	7	6	5	4	3	2	1	0
Reserved												CLKSO URCE	TICK INT	EN ABLE	
												rw	rw	rw	

Bits 31:17 Reserved, must be kept cleared.

Bit 16 **COUNTFLAG**:

Returns 1 if timer counted to 0 since last time this was read.

Bits 15:3 Reserved, must be kept cleared.

Bit 2 **CLKSOURCE**: Clock source selection

Selects the clock source.

0: AHB/8

1: Processor clock (AHB)

Bit 1 **TICKINT**: SysTick exception request enable

0: Counting down to zero does not assert the SysTick exception request

1: Counting down to zero asserts the SysTick exception request.

Note: Software can use COUNTFLAG to determine if SysTick has ever counted to zero.

Bit 0 **ENABLE**: Counter enable

Enables the counter. When ENABLE is set to 1, the counter loads the RELOAD value from the LOAD register and then counts down. On reaching 0, it sets the COUNTFLAG to 1 and optionally asserts the SysTick depending on the value of TICKINT. It then loads the RELOAD value again, and begins counting.

0: Counter disabled

1: Counter enabled

4.5.2 SysTick reload value register (STK_LOAD)

Address offset: 0x04

Reset value: 0x0000 0000

Required privilege: Privileged

	31	30	29	28	27	26	25	24	23	22	21	20	19	18	17	16
Reserved									RELOAD[23:16]							
									rw	rw	rw	rw	rw	rw	rw	rw
15	14	13	12	11	10	9	8	7	6	5	4	3	2	1	0	
RELOAD[15:0]																
rw	rw	rw	rw	rw	rw	rw	rw	rw	rw	rw	rw	rw	rw	rw	rw	rw

Bits 31:24 Reserved, must be kept cleared.

Bits 23:0 **RELOAD[23:0]**: RELOAD value

The LOAD register specifies the start value to load into the VAL register when the counter is enabled and when it reaches 0.

Calculating the RELOAD value

The RELOAD value can be any value in the range 0x00000001-0x00FFFFFF. A start value of 0 is possible, but has no effect because the SysTick exception request and COUNTFLAG are activated when counting from 1 to 0.

The RELOAD value is calculated according to its use:

- I To generate a multi-shot timer with a period of N processor clock cycles, use a RELOAD value of N-1. For example, if the SysTick interrupt is required every 100 clock pulses, set RELOAD to 99.
- I To deliver a single SysTick interrupt after a delay of N processor clock cycles, use a RELOAD of value N. For example, if a SysTick interrupt is required after 400 clock pulses, set RELOAD to 400.

4.5.3 SysTick current value register (STK_VAL)

Address offset: 0x08

Reset value: 0x0000 0000

Required privilege: Privileged

31	30	29	28	27	26	25	24	23	22	21	20	19	18	17	16
Reserved								CURRENT[23:16]							
								rw	rw	rw	rw	rw	rw	rw	rw
15	14	13	12	11	10	9	8	7	6	5	4	3	2	1	0
CURRENT[15:0]															
rw	rw	rw	rw	rw	rw	rw	rw	rw	rw	rw	rw	rw	rw	rw	rw

Bits 31:24 Reserved, must be kept cleared.

Bits 23:0 **CURRENT[23:0]**: Current counter value

The VAL register contains the current value of the SysTick counter.

Reads return the current value of the SysTick counter.

A write of any value clears the field to 0, and also clears the COUNTFLAG bit in the STK_CTRL register to 0.

4.5.4 SysTick calibration value register (STK_CALIB)

Address offset: 0x0C

Reset value: 0x0002328

Required privilege: Privileged

The CALIB register indicates the SysTick calibration properties.

31	30	29	28	27	26	25	24	23	22	21	20	19	18	17	16	
NO REF	SKEW	Reserved						TENMS[23:16]								
								r	r	r	r	r	r	r	r	r
r	r							r	r	r	r	r	r	r	r	r
15	14	13	12	11	10	9	8	7	6	5	4	3	2	1	0	
TENMS[15:0]																
r	r	r	r	r	r	r	r	r	r	r	r	r	r	r	r	

Bit 31 **NOREF**: NOREF flag

Reads as zero. Indicates that a separate reference clock is provided. The frequency of this clock is HCLK/8.

Bit 30 **SKEW**: SKEW flag

Reads as one. Calibration value for the 1 ms inexact timing is not known because TENMS is not known. This can affect the suitability of SysTick as a software real time clock.

Bits 29:24 Reserved, must be kept cleared.

Bits 23:0 **TENMS[23:0]**: Calibration value

Indicates the calibration value when the SysTick counter runs on HCLK max/8 as external clock. The value is product dependent, please refer to the Product Reference Manual, SysTick Calibration Value section. When HCLK is programmed at the maximum frequency, the SysTick period is 1ms.

If calibration information is not known, calculate the calibration value required from the frequency of the processor clock or external clock.

4.5.5 SysTick design hints and tips

The SysTick counter runs on the processor clock. If this clock signal is stopped for low power mode, the SysTick counter stops.

Ensure software uses aligned word accesses to access the SysTick registers.

4.5.6 SysTick register map

The table provides shows the SysTick register map and reset values. The base address of the SysTick register block is 0xE000 E010.

Table 49. SysTick register map and reset values

Offset	Register	31	30	29	28	27	26	25	24	23	22	21	20	19	18	17	16	15	14	13	12	11	10	9	8	7	6	5	4	3	2	1	0													
0x00	STK_CTRL	Reserved															COUNTFLAG	Reserved											CLKSOURCE	TICK INT	EN ABLE															
	Reset Value																0												1	0	0															
0x04	STK_LOAD	Reserved															RELOAD[23:0]																													
	Reset Value																0	0	0	0	0	0	0	0	0	0	0	0	0	0	0	0	0	0	0	0	0	0	0	0	0	0	0	0	0	0
0x08	STK_VAL	Reserved															CURRENT[23:0]																													
	Reset Value																0	0	0	0	0	0	0	0	0	0	0	0	0	0	0	0	0	0	0	0	0	0	0	0	0	0	0	0	0	0
0x0C	STK_CALIB	Reserved															TENMS[23:0]																													
	Reset Value																0	0	0	0	0	0	0	0	0	0	0	0	0	0	0	0	0	0	0	0	0	0	0	0	0	0	0	0	0	0

5 Revision history

Table 50. Document revision history

Date	Revision	Changes
03-Apr-2009	1	Initial release.
26-Oct-2009	2	Table 45: Priority grouping modified.
16-Apr-2010	3	Modified Table 14: Peripheral memory bit-banding regions on page 28 (peripheral bit-band alias and peripheral bit-band region swapped) Added Section 4.2: Memory protection unit (MPU) on page 105 . Modified Table 44: NVIC register map and reset values on page 128 supporting up to 81 interrupts
28-Feb-2011	4	Added reference to STM32F20xxx, STM32F21xxx and STM32L1xx products in title and first page. Modified NVIC_ISPR0 register base moved to offset 0x100 in Table 44: NVIC register map and reset values on page 128 . To support STM32L and STM32F2 series based on r2p0 core: Added SCB_ACTLR register, modified SCB_CPUID and SCB_CCR registers .
27-May-2013	5	Modified bit numbers in register description for Section 4.4.4: Vector table offset register (SCB_VTOR) . Modified STK_CTRL reset value in Section 4.5.1: SysTick control and status register (STK_CTRL) .

Please Read Carefully:

Information in this document is provided solely in connection with ST products. STMicroelectronics NV and its subsidiaries ("ST") reserve the right to make changes, corrections, modifications or improvements, to this document, and the products and services described herein at any time, without notice.

All ST products are sold pursuant to ST's terms and conditions of sale.

Purchasers are solely responsible for the choice, selection and use of the ST products and services described herein, and ST assumes no liability whatsoever relating to the choice, selection or use of the ST products and services described herein.

No license, express or implied, by estoppel or otherwise, to any intellectual property rights is granted under this document. If any part of this document refers to any third party products or services it shall not be deemed a license grant by ST for the use of such third party products or services, or any intellectual property contained therein or considered as a warranty covering the use in any manner whatsoever of such third party products or services or any intellectual property contained therein.

UNLESS OTHERWISE SET FORTH IN ST'S TERMS AND CONDITIONS OF SALE ST DISCLAIMS ANY EXPRESS OR IMPLIED WARRANTY WITH RESPECT TO THE USE AND/OR SALE OF ST PRODUCTS INCLUDING WITHOUT LIMITATION IMPLIED WARRANTIES OF MERCHANTABILITY, FITNESS FOR A PARTICULAR PURPOSE (AND THEIR EQUIVALENTS UNDER THE LAWS OF ANY JURISDICTION), OR INFRINGEMENT OF ANY PATENT, COPYRIGHT OR OTHER INTELLECTUAL PROPERTY RIGHT.

ST PRODUCTS ARE NOT AUTHORIZED FOR USE IN WEAPONS. NOR ARE ST PRODUCTS DESIGNED OR AUTHORIZED FOR USE IN: (A) SAFETY CRITICAL APPLICATIONS SUCH AS LIFE SUPPORTING, ACTIVE IMPLANTED DEVICES OR SYSTEMS WITH PRODUCT FUNCTIONAL SAFETY REQUIREMENTS; (B) AERONAUTIC APPLICATIONS; (C) AUTOMOTIVE APPLICATIONS OR ENVIRONMENTS, AND/OR (D) AEROSPACE APPLICATIONS OR ENVIRONMENTS. WHERE ST PRODUCTS ARE NOT DESIGNED FOR SUCH USE, THE PURCHASER SHALL USE PRODUCTS AT PURCHASER'S SOLE RISK, EVEN IF ST HAS BEEN INFORMED IN WRITING OF SUCH USAGE, UNLESS A PRODUCT IS EXPRESSLY DESIGNATED BY ST AS BEING INTENDED FOR "AUTOMOTIVE, AUTOMOTIVE SAFETY OR MEDICAL" INDUSTRY DOMAINS ACCORDING TO ST PRODUCT DESIGN SPECIFICATIONS. PRODUCTS FORMALLY ESCC, QML OR JAN QUALIFIED ARE DEEMED SUITABLE FOR USE IN AEROSPACE BY THE CORRESPONDING GOVERNMENTAL AGENCY.

Resale of ST products with provisions different from the statements and/or technical features set forth in this document shall immediately void any warranty granted by ST for the ST product or service described herein and shall not create or extend in any manner whatsoever, any liability of ST.

ST and the ST logo are trademarks or registered trademarks of ST in various countries.

Information in this document supersedes and replaces all information previously supplied.

The ST logo is a registered trademark of STMicroelectronics. All other names are the property of their respective owners.

© 2013 STMicroelectronics - All rights reserved

STMicroelectronics group of companies

Australia - Belgium - Brazil - Canada - China - Czech Republic - Finland - France - Germany - Hong Kong - India - Israel - Italy - Japan - Malaysia - Malta - Morocco - Philippines - Singapore - Spain - Sweden - Switzerland - United Kingdom - United States of America

www.st.com