

**DESCRIPTION**

SRC Device's epoxy molded DIP 14 Series offers a variety of contacts and schematics to meet the needs of a wide range of applications. It features the MVS2/MVS7 models designed for high reliability. The MSS2/7 DIPs are 1-Form-A relays equipped with the MYAD® all-position mounting switch. With switching up to 50 Watts and a 4000V isolation option, the DIP 14 Series is a relay package that allows for automatic insertion directly on PCBs as well as insertion into standard 14 Pin DIP sockets.

**FEATURES**

- All position mercury contacts on some models
- Stable contact resistance over life
- 4000 Vac input-output isolation
- Bounce free operation
- High insulation resistance
- Switching speed of 300Hz
- Long life > 1 billion operations
- Epoxy molded for automatic board processing
- FCC68 compatible (MSS2 & MSS7)

**APPLICATIONS**

- Automatic test equipment
- Process control
- Industrial
- Telecom
- Datacom
- High-end security systems
- Signaling
- Metering

**APPROVALS**

- UL approval (DSS7 & PRMA)
- EN 60950 certified (MVS7, DSS7 & MSS7)
- CSA approval (PRMA)

**RATINGS (@ 25° C)**

| Parameter           | Min | Typ | Max  | Unit  |
|---------------------|-----|-----|------|-------|
| Switching Voltage   |     |     |      |       |
| PRMA/PRME/DSS7      |     |     | 200  | Volts |
| PRMA Form C         |     |     | 100  | Volts |
| MSS2/MSS7           |     |     | 500  | Volts |
| MVS2/MVS7           |     |     | 1000 | Volts |
| Switching Current   |     |     |      |       |
| PRMA/PRME/DSS7      |     |     | 0.5  | Amps  |
| PRMA Form C         |     |     | 0.25 | Amps  |
| MSS2/MSS7/MVS2/MVS7 |     |     | 2    | Amps  |
| Carry Current       |     |     |      |       |
| PRMA/PRME/DSS7      |     |     | 2    | Amps  |
| PRMA Form C         |     |     | 0.4  | Amps  |
| MSS2/MSS7           |     |     | 3    | Amps  |
| MVS2/MVS7           |     |     | 3    | Amps  |
| Switching Frequency |     |     |      |       |
| PRMA/PRME/DSS7      |     |     | 500  | Hz    |
| PRMA Form C         |     |     | 50   | Hz    |
| MSS2/MSS7/MVS2/MVS7 |     |     | 200  | Hz    |
| Contact Resistance  |     |     |      |       |
| PRMA/PRME/DSS7      |     |     | 150  | mΩ    |
| PRMA Form C         |     |     | 200  | mΩ    |
| MSS2/MSS7/MVS2/MVS7 |     |     | 100  | mΩ    |

(See detailed specifications for more information.)

# DIP 14 SERIES REED RELAYS

MSS2 ■ MSS7 ■ PRMA ■ DSS7 ■ PRME ■ MVS2 ■ MVS7



## SPECIFICATIONS

All parameters are at 25°C unless otherwise stated.  
Operate voltage, release voltage, and coil resistance will change approximately 0.4%/°C as ambient temperature varies.

**MSS2**  
Molded 8 Pin  
All position  
Wetted contacts

**MSS7**  
Molded 4 Pin  
All position  
Wetted contacts

| PARAMETER                          | CONDITIONS  | SYMBOL | MIN             | TYP              | MAX  | MIN             | TYP              | MAX  | UNITS                |
|------------------------------------|---|--------|-----------------|------------------|------|-----------------|------------------|------|----------------------|
| <b>Contact Ratings</b>             |   |        |                 |                  |      |                 |                  |      |                      |
| Switching Voltage                  | Max DC/PeakAC Resistive                                 | VL     | -               | -                | 500  | -               | -                | 500  | Volts                |
| Switching Current                  | Max DC/PeakAC Resistive                                 | IL     | -               | -                | 2    | -               | -                | 2    | Amps                 |
| Carry Current                      | Max DC/PeakAC Resistive                                 | Ic     | -               | -                | 3    | -               | -                | 3    | Amps                 |
| Contact Rating                     | Max DC/PeakAC Resistive                                 |        | -               | -                | 50   | -               | -                | 50   | Watts                |
| Life Expectancy                    | Signal Level 1.0 V 10mA<br>Related Loads <sup>(1)</sup> |        | -               | 200              | -    | -               | 200              | -    | x10 <sup>6</sup> Ops |
| Static Contact Resistance          | 50mV, 10mA  | CR     | -               | 40               | 100  | -               | 65               | 100  | mΩ                   |
| Dynamic Contact Resistance         | .5V, 50mA at 100Hz, 1.5 msec                            | DCR    | -               | N/A              | -    | -               | N/A              | -    | mΩ                   |
| Contact Material                   |   |        | -               | Hg               | -    | -               | Hg               | -    |                      |
| Hg Content                         |   |        | -               | 16               | -    | -               | 16               | -    | mgrams               |
| <b>Relay Specifications</b>        |   |        |                 |                  |      |                 |                  |      |                      |
| Insulation Resistance              | Between all isolated pins<br>at 100V, 25°C, 40% RH      | IR     | 10 <sup>8</sup> | 10 <sup>10</sup> | -    | 10 <sup>8</sup> | 10 <sup>10</sup> | -    | Ω                    |
| Capacitance                        | Across Open Contacts                                    |        | -               | 1.5              | 2    | -               | 1.2              | 2    | pF                   |
|                                    | Open Contact to Coil                                    |        | -               | 3                | 4    | -               | 3                | 4    | pF                   |
| Dielectric Strength                | Between Contacts  |        | 1400            | -                | -    | 2000            | -                | -    | VDC/Peak AC          |
|                                    | Contacts to Coil  | I/O    | 1400            | -                | -    | 5600            | -                | -    | VDC/Peak AC          |
| Operate Time,<br>including bounce  | At Nominal Coil Voltage<br>10Hz Square Wave             | TOP    | -               | 1.2              | 1.75 | -               | 1.2              | 1.75 | ms                   |
| Release Time                       | Zener-Diode Suppression                                 | TREL   | -               | 1                | 1.50 | -               | 1                | 1.50 | ms                   |
| <b>Environmental Ratings</b>       |   |        |                 |                  |      |                 |                  |      |                      |
| Storage Temperature                |   | TA     | -40             | -                | +105 | -40             | -                | +105 | °C                   |
| Operating Temperature              |   | To     | -38             | -                | +75  | -38             | -                | +75  | °C                   |
| Soldering Temperature              | Applied to pins, 5 sec. max.                            |        | -               | 260              | -    | -               | 260              | -    | °C                   |
| Vibration Resistance<br>(Survival) | 10Hz - 500Hz  | G      | -               | -                | 10   | -               | -                | 10   | Gs                   |
| Shock Resistance<br>(Survival)     | 11±1ms, 1/2 Sine Wave                                   | S      | -               | -                | 30   | -               | -                | 30   | Gs                   |
| Weight                             |   |        | -               | 2.3              | -    | -               | 2.3              | -    | grams                |

(1) Refer to life graphs

**SPECIFICATIONS**

All parameters are at 25°C unless otherwise stated.  
Operate voltage, release voltage, and coil resistance will change approximately 0.4%/°C as ambient temperature varies.

**PRMA**  
Molded 8 Pin  
Form-C  
Dry Reed

**PRMA**  
Molded 8 Pin  
Form-A&B  
Dry Reed

| PARAMETER                                      | CONDITIONS  | SYMBOL | MIN             | TYP              | MAX  | MIN              | TYP              | MAX  | UNITS                |
|--|---|--------|-----------------|------------------|------|------------------|------------------|------|----------------------|
| <b>Contact Ratings</b>                         |   |        |                 |                  |      |                  |                  |      |                      |
| Switching Voltage                              | Max DC/PeakAC Resistive   | VL     | -               | -                | 100  | -                | -                | 200  | Volts                |
| Switching Current                              | Max DC/PeakAC Resistive   | IL     | -               | -                | 0.25 | -                | -                | 0.5  | Amps                 |
| Carry Current                                  | Max DC/PeakAC Resistive   | Ic     | -               | -                | 0.4  | -                | -                | 2    | Amps                 |
| Contact Rating                                 | Max DC/PeakAC Resistive   |        | -               | -                | 3    | -                | -                | 10   | Watts                |
| Life Expectancy                                | Signal Level 1.0V 10mA<br>Related Loads <sup>(1)</sup>          |        | -               | 20               | -    | 300              | 500              | -    | x10 <sup>6</sup> Ops |
| Static Contact Resistance                      | 50mV, 10mA  | CR     | -               | -                | 200  | -                | -                | 150  | mΩ                   |
| Dynamic Contact Resistance                     | .5V, 50mA at 100Hz, 1.5 msec                                    | DCR    | -               | N/A              | -    | -                | N/A              | -    | mΩ                   |
| Contact Material                               |   |        | -               | Rh               | -    | -                | Ru               | -    |                      |
| <b>Relay Specifications</b>                    |   |        |                 |                  |      |                  |                  |      |                      |
| Insulation Resistance                          | Between all isolated pins at 100V, 25°C, 40% RH                 | IR     | 10 <sup>9</sup> | 10 <sup>10</sup> | -    | 10 <sup>10</sup> | 10 <sup>12</sup> | -    | Ω                    |
| Capacitance                                    | Across Open Contacts  |        | -               | 2.5              | 3    | -                | 0.7              | 1    | pF                   |
|  | Open Contact to Coil  |        | -               | 3                | 3    | -                | 1.5              | 2    | pF                   |
| Dielectric Strength                            | Between Contacts  |        | 250             | -                | -    | 250              | -                | -    | VDC/Peak AC          |
|  | Contacts to Coil  | I/O    | 1400            | -                | -    | 1400             | -                | -    | VDC/Peak AC          |
| Operate Time, including bounce                 | At Nominal Coil Voltage<br>10Hz Square Wave                     | TOP    | -               | 1.5              | 2    | -                | .25              | 0.5  | ms                   |
| Release Time                                   | Zener-Diode Suppression   | TREL   | -               | 1.5              | 3    | -                | .25              | 0.5  | ms                   |
| <b>Environmental Ratings</b>                   |   |        |                 |                  |      |                  |                  |      |                      |
| Storage Temperature                            |   | TA     | -40             | -                | +105 | -40              | -                | +105 | °C                   |
| Operating Temperature                          |   | To     | -40             | -                | +80  | -40              | -                | +80  | °C                   |
| Soldering Temperature                          | Applied to pins, 5 sec. max.                                    |        | -               | 260              | -    | -                | -                | 260  | °C                   |
| Vibration Resistance <sup>(2)</sup> (Survival) | 10 Hz - 500 Hz for PRMA Form A&B<br>5Hz - 500Hz for PRMA Form C | G      | -               | -                | 10   | -                | -                | 20   | Gs                   |
| Shock Resistance (Survival)                    | 11±1ms, 1/2 Sine Wave   | S      | -               | -                | 50   | -                | -                | 100  | Gs                   |
| Weight   |   |        | -               | 1.5              | -    | -                | 1.5              | -    | grams                |

<sup>(1)</sup> Refer to life graphs

<sup>(2)</sup> Use caution not to exceed vibration resistance limits while ultrasonically cleaning relays with DYAD switches. Contact SRC Devices Engineering for more details/recommendations.

## DIP 14 SERIES REED RELAYS

MSS2 ■ MSS7 ■ PRMA ■ DSS7 ■ PRME ■ MVS2 ■ MVS7



### SPECIFICATIONS

All parameters are at 25°C unless otherwise stated.  
Operate voltage, release voltage, and coil resistance will change approximately 0.4%/°C as ambient temperature varies.

**DSS7**  
Molded 4 Pin  
Dry Reed

**PRME**  
Molded 8 Pin  
Low profile  
Dry Reed

| PARAMETER   | CONDITIONS  | SYMBOL           | MIN              | TYP              | MAX  | MIN              | TYP              | MAX  | UNITS                |
|---|---|------------------|------------------|------------------|------|------------------|------------------|------|----------------------|
| <b>Contact Ratings</b>                            |   |                  |                  |                  |      |                  |                  |      |                      |
| Switching Voltage                                 | Max DC/PeakAC Resistive                                 | VL               | -                | -                | 200  | -                | -                | 200  | Volts                |
| Switching Current                                 | Max DC/PeakAC Resistive                                 | IL               | -                | -                | 0.5  | -                | -                | 0.5  | Amps                 |
| Carry Current                                     | Max DC/PeakAC Resistive                                 | Ic               | -                | -                | 2    | -                | -                | 2    | Amps                 |
| Contact Rating                                    | Max DC/PeakAC Resistive                                 |                  | -                | -                | 10   | -                | -                | 10   | Watts                |
| Life Expectancy                                   | Signal Level 1.0 V 10mA<br>Related Loads <sup>(1)</sup> |                  | 300              | 500              | -    | 300              | 500              | -    | x10 <sup>6</sup> Ops |
| Static Contact Resistance                         | 50mV, 10mA  | CR               | -                | -                | 150  | -                | -                | 150  | mΩ                   |
| Dynamic Contact Resistance                        | .5V, 50mA at 100Hz, 1.5 msec                            | DCR              | -                | N/A              | -    | -                | N/A              | -    | mΩ                   |
| Contact Material                                  |   |                  | -                | Ru               | -    | -                | Ru               | -    |                      |
| <b>Relay Specifications</b>                       |   |                  |                  |                  |      |                  |                  |      |                      |
| Insulation Resistance                             | Between all isolated pins<br>at 100V, 25°C, 40% RH      | IR               | 10 <sup>10</sup> | 10 <sup>12</sup> | -    | 10 <sup>10</sup> | 10 <sup>12</sup> | -    | Ω                    |
| Capacitance                                       | Across Open Contacts                                    |                  | -                | 0.7              | 1    | -                | 0.8              | 1    | pF                   |
| Dielectric Strength                               | Open Contact to Coil                                    |                  | -                | 1.5              | 2    | -                | 1.5              | 2    | pF                   |
|   | Between Contacts  |                  | 250              | -                | -    | 250              | -                | -    | VDC/Peak AC          |
| Operate Time,<br>including bounce                 | Contacts to Coil  | I/O              | 5600             | -                | -    | 1000             | -                | -    | VDC/Peak AC          |
|   | At Nominal Coil Voltage                                 | T <sub>OP</sub>  | -                | 0.25             | 0.5  | -                | 0.25             | 1    | ms                   |
| Release Time                                      | 10Hz Square Wave<br>Zener-Diode Suppression             | T <sub>REL</sub> | -                | 0.25             | 0.5  | -                | 0.25             | 0.5  | ms                   |
| <b>Environmental Ratings</b>                      |   |                  |                  |                  |      |                  |                  |      |                      |
| Storage Temperature                               |   | T <sub>A</sub>   | -40              | -                | +105 | -40              | -                | +105 | °C                   |
| Operating Temperature                             |   | T <sub>O</sub>   | -40              | -                | +80  | -40              | -                | +80  | °C                   |
| Soldering Temperature                             | Applied to pins, 5 sec. max.                            |                  | -                | -                | 260  | -                | -                | 260  | °C                   |
| Vibration Resistance <sup>(2)</sup><br>(Survival) | 5Hz - 500Hz   | G                | -                | -                | 20   | -                | -                | 20   | Gs                   |
| Shock Resistance<br>(Survival)                    | 11±1ms, 1/2 Sine Wave                                   | S                | -                | -                | 100  | -                | -                | 100  | Gs                   |
| Weight  |   |                  | -                | 1.5              | -    | -                | 1.5              | -    | grams                |

(1) Refer to life graphs

(2) Use caution not to exceed vibration resistance limits while ultrasonically cleaning relays with DYAD switches. Contact SRC Devices Engineering for more details/recommendations.

**SPECIFICATIONS**

All parameters are at 25°C unless otherwise stated.  
Operate voltage, release voltage, and coil resistance will change approximately 0.4%/°C as ambient temperature varies.

**MVS2**  
8 Pin DIP  
Wetted Contacts<sup>(3)</sup>

**MVS7**  
4 Pin DIP  
Wetted Contacts<sup>(3)</sup>

| PARAMETER   | CONDITIONS                                      | SYMBOL           | MIN              | TYP              | MAX                 | MIN              | TYP              | MAX                 | UNITS                |
|---|---|------------------|------------------|------------------|---------------------|------------------|------------------|---------------------|----------------------|
| <b>Contact Ratings</b>                            |   |                  |                  |                  |                     |                  |                  |                     |                      |
| Switching Voltage                                 | Max DC/PeakAC Resistive                         | VL               | -                | -                | 1000 <sup>(1)</sup> | -                | -                | 1000 <sup>(1)</sup> | Volts                |
| Switching Current                                 | Max DC/PeakAC Resistive                         | IL               | -                | -                | 2                   | -                | -                | 2                   | Amps                 |
| Carry Current                                     | Max DC/PeakAC Resistive                         | Ic               | -                | -                | 3                   | -                | -                | 3                   | Amps                 |
| Contact Rating                                    | Max DC/PeakAC Resistive                         |                  | -                | -                | 50                  | -                | -                | 50                  | Watts                |
| Life Expectancy                                   | Signal Level 1.0 V 10mA                         |                  | 1000             | -                | -                   | 1000             | -                | -                   | x10 <sup>6</sup> Ops |
|   | 50V, 1A   |                  | -                | 2                | -                   | -                | 2                | -                   | x10 <sup>6</sup> Ops |
|   | 500V, 100mA<br>Related Loads <sup>(2)</sup>     |                  | -                | 50               | -                   | -                | 50               | -                   | x10 <sup>6</sup> Ops |
| Static Contact Resistance                         | 50mV, 10mA                                      | CR               | -                | -                | 100                 | -                | -                | 100                 | mΩ                   |
| Contact Material                                  |   |                  | -                | Hg               | -                   | -                | Hg               | -                   |                      |
| Hg Content  |   |                  | -                | 40               | -                   | -                | 40               | -                   | mgrams               |
| <b>Relay Specifications</b>                       |   |                  |                  |                  |                     |                  |                  |                     |                      |
| Insulation Resistance                             | Between all isolated pins at 100V, 25°C, 40% RH | IR               | 10 <sup>10</sup> | 10 <sup>12</sup> | -                   | 10 <sup>10</sup> | 10 <sup>12</sup> | -                   | Ω                    |
| Capacitance                                       | Across Open Contacts                            |                  | -                | 0.7              | -                   | -                | 0.7              | -                   | pF                   |
|   | Upper Contact to Coil                           |                  | -                | 1.2              | -                   | -                | 1.5              | -                   | pF                   |
|   | Closed Contact to Coil                          |                  | -                | 3.2              | -                   | -                | 2.5              | -                   | pF                   |
| Dielectric Strength                               | Open Contacts                                   |                  | 1400             | -                | -                   | 2000             | -                | -                   | VDC/Peak AC          |
|   | Contacts to Coil                                | I/O              | 1400             | -                | -                   | 5600             | -                | -                   | VDC/Peak AC          |
| Operate Time                                      | At Nominal Coil Voltage<br>10Hz Square Wave     | T <sub>OP</sub>  | -                | 1.5              | 2.5                 | -                | 1.5              | 2.5                 | ms                   |
| Release Time                                      | Zener-Diode Suppression                         | T <sub>REL</sub> | -                | 1                | 2.5                 | -                | 1                | 2.5                 | ms                   |
| <b>Environmental Ratings</b>                      |   |                  |                  |                  |                     |                  |                  |                     |                      |
| Storage Temperature                               |   | T <sub>A</sub>   | -40              | -                | +105                | -40              | -                | +105                | °C                   |
| Operating Temperature                             |   | T <sub>O</sub>   |                  |                  | +260                |                  |                  | +260                | °C                   |
| Soldering Temperature                             | Applied to pins, 5 sec. max.                    |                  | -38              | -                | +85                 | -38              | -                | +85                 | °C                   |
| Vibration Resistance <sup>(2)</sup><br>(Survival) | 10Hz - 500Hz                                    | G                | -                | -                | 10                  | -                | -                | 10                  | Gs                   |
| Shock Resistance<br>(Survival)                    | 11±1ms, 1/2 Sine Wave                           | S                | -                | -                | 30                  | -                | -                | 30                  | Gs                   |
| Weight  |   |                  | -                | 2.1              | -                   | -                | 2.1              | -                   | grams                |

<sup>(1)</sup> Current limited up to 5mA, minimum 20 million operations; for further information, consult factory

<sup>(2)</sup> Refer to life graphs

<sup>(3)</sup> Relay contains mercury wetted contacts and must be mounted vertically. Pin 1 is up.

# DIP 14 SERIES REED RELAYS

MSS2 ■ MSS7 ■ PRMA ■ DSS7 ■ PRME ■ MVS2 ■ MVS7



## COIL SPECIFICATIONS

|                | Contact Form | Coil Voltage |     |      | Coil Resistance |      |      | Operate Voltage        |     |      | Release Voltage        |     |     | Nominal Input Power |     |     |
|----------------|--------------|--------------|-----|------|-----------------|------|------|------------------------|-----|------|------------------------|-----|-----|---------------------|-----|-----|
| Units          |              | Volts        |     |      | Ω               |      |      | Volts                  |     |      | Volt                   |     |     | mW                  |     |     |
| Conditions     |              |              |     |      | +/- 10% (25°C)  |      |      | Must operate by (25°C) |     |      | Must release by (25°C) |     |     |                     |     |     |
| Part #         |              | Min          | Typ | Max  | Min             | Typ  | Max  | Min                    | Typ | Max  | Min                    | Typ | Max | Min                 | Typ | Max |
| MSS2 1A05      | 1-Form-A     |              | 5   | 11   | 126             | 140  | 154  |                        |     | 3.75 | 0.5                    |     |     |                     |     | 179 |
| MSS2 1A12      | 1-Form-A     |              | 12  | 21   | 450             | 500  | 550  |                        |     | 9    | 1                      |     |     |                     |     | 288 |
| MSS2 1A24      | 1-Form-A     |              | 24  | 44   | 1935            | 2150 | 2365 |                        |     | 18   | 2                      |     |     |                     |     | 268 |
| MSS7 1A05      | 1-Form-A     |              | 5   | 11   | 126             | 140  | 154  |                        |     | 3.75 | 0.5                    |     |     |                     |     | 179 |
| MSS7 1A12      | 1-Form-A     |              | 12  | 21   | 450             | 500  | 550  |                        |     | 9    | 1                      |     |     |                     |     | 288 |
| MSS7 1A24      | 1-Form-A     |              | 24  | 43   | 1935            | 2150 | 2365 |                        |     | 18   | 2                      |     |     |                     |     | 268 |
| PRMA 1A05      | 1-Form-A     |              | 5   | 21   | 450             | 500  | 550  |                        |     | 3.75 | 0.8                    |     |     |                     |     | 50  |
| PRMA 1A12      | 1-Form-A     |              | 12  | 30   | 900             | 1000 | 1100 |                        |     | 9    | 1                      |     |     |                     |     | 144 |
| PRMA 1A24      | 1-Form-A     |              | 24  | 44   | 1935            | 2150 | 2365 |                        |     | 18   | 2                      |     |     |                     |     | 268 |
| PRMA 1B05      | 1-Form-B     |              | 5   | 6    | 450             | 500  | 550  |                        |     | 3.75 | 0.8                    |     |     |                     |     | 50  |
| PRMA 1B12      | 1-Form-B     |              | 12  | 14.5 | 900             | 1000 | 1100 |                        |     | 9    | 1                      |     |     |                     |     | 144 |
| PRMA 1B24      | 1-Form-B     |              | 24  | 29   | 1935            | 2150 | 2365 |                        |     | 18   | 2                      |     |     |                     |     | 268 |
| PRMA 1C05      | 1-Form-C     |              | 5   | 12   | 180             | 200  | 220  |                        |     | 3.75 | 0.8                    |     |     |                     |     | 125 |
| PRMA 1C12      | 1-Form-C     |              | 12  | 18   | 450             | 500  | 550  |                        |     | 9    | 1                      |     |     |                     |     | 288 |
| PRMA 1C24      | 1-Form-C     |              | 24  | 32   | 1935            | 2150 | 2365 |                        |     | 18   | 2                      |     |     |                     |     | 268 |
| PRMA 2A05      | 2-Form-A     |              | 5   | 11   | 126             | 140  | 154  |                        |     | 3.75 | 0.8                    |     |     |                     |     | 179 |
| PRMA 2A12      | 2-Form-A     |              | 12  | 21   | 450             | 500  | 550  |                        |     | 9    | 1                      |     |     |                     |     | 288 |
| PRMA 2A24      | 2-Form-A     |              | 24  | 44   | 1935            | 2150 | 2365 |                        |     | 18   | 2                      |     |     |                     |     | 268 |
| PRMA 10037     | 1-Form-A     |              | 5   | 15   | 342             | 380  | 418  |                        |     | 3.75 | 0.8                    |     |     |                     |     | 66  |
| PRMA 10038     | 1-Form-A     |              | 12  | 19   | 477             | 530  | 583  |                        |     | 9    | 1                      |     |     |                     |     | 272 |
| PRMA 10039     | 1-Form-A     |              | 24  | 32   | 1800            | 2000 | 2200 |                        |     | 18   | 2                      |     |     |                     |     | 288 |
| DSS7 1A05      | 1-Form-A     |              | 5   | 21   | 450             | 500  | 550  |                        |     | 3.75 | 0.8                    |     |     |                     |     | 50  |
| DSS7 1A12      | 1-Form-A     |              | 12  | 30   | 900             | 1000 | 1100 |                        |     | 9    | 1                      |     |     |                     |     | 144 |
| DSS7 1A24      | 1-Form-A     |              | 24  | 44   | 1935            | 2150 | 2365 |                        |     | 18   | 2                      |     |     |                     |     | 268 |
| PRME 25005     | 1-Form-A     |              | 5   | 19   | 450             | 500  | 550  |                        |     | 3.8  | 0.8                    |     |     |                     |     | 50  |
| PRME 15005     | 1-Form-A     |              | 5   | 15   | 342             | 380  | 418  |                        |     | 3.5  | 1                      |     |     |                     |     | 66  |
| PRME 15002     | 1-Form-A     |              | 12  | 19   | 477             | 530  | 583  |                        |     | 8    | 1                      |     |     |                     |     | 272 |
| PRME 15003     | 1-Form-A     |              | 24  | 32   | 1800            | 2000 | 2200 |                        |     | 16   | 2                      |     |     |                     |     | 288 |
| MVS2 1A05(A,B) | 1-Form-A     |              | 5   | 7    | 94.5            | 105  | 116  |                        |     | 3.75 | 0.5                    |     |     |                     |     | 238 |
| MVS2 1A12(A,B) | 1-Form-A     |              | 12  | 15   | 450             | 500  | 550  |                        |     | 9    | 1                      |     |     |                     |     | 288 |
| MVS2 1A24(A,B) | 1-Form-A     |              | 24  | 30   | 1935            | 2150 | 2365 |                        |     | 18   | 2                      |     |     |                     |     | 268 |
| MVS7 1A05(S)   | 1-Form-A     |              | 5   | 7    | 94.5            | 105  | 116  |                        |     | 3.75 | 0.5                    |     |     |                     |     | 238 |
| MVS7 1A12(S)   | 1-Form-A     |              | 12  | 15   | 450             | 500  | 550  |                        |     | 9    | 1                      |     |     |                     |     | 288 |
| MVS7 1A24(S)   | 1-Form-A     |              | 24  | 30   | 1935            | 2150 | 2365 |                        |     | 18   | 2                      |     |     |                     |     | 268 |

### PERFORMANCE GRAPHS

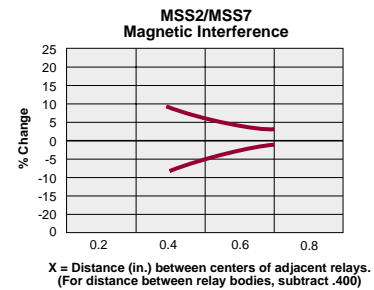
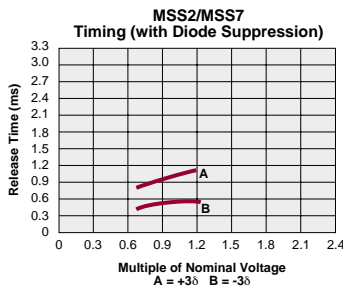
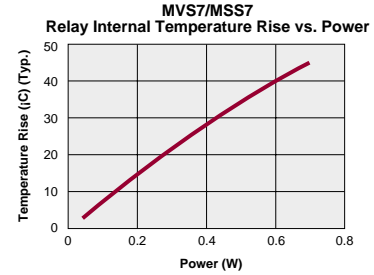
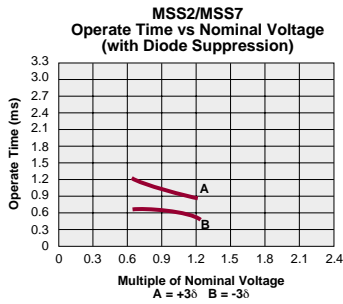
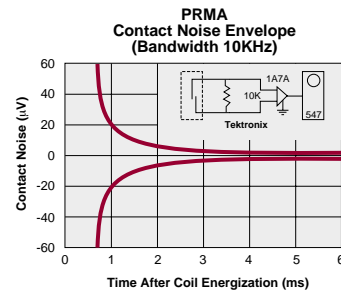
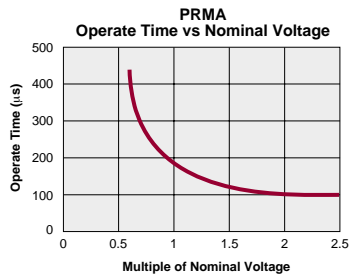
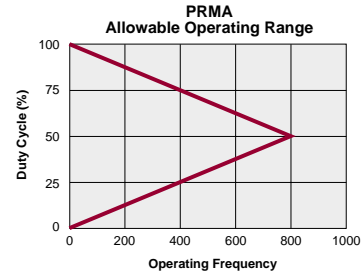
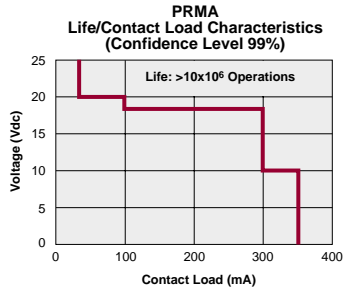

# DIP 14 SERIES REED RELAYS

MSS2 ■ MSS7 ■ PRMA ■ DSS7 ■ PRME ■ MVS2 ■ MVS7



DIMENSIONS  
mm  
(inches)

## MECHANICAL DIMENSIONS

### PRMA

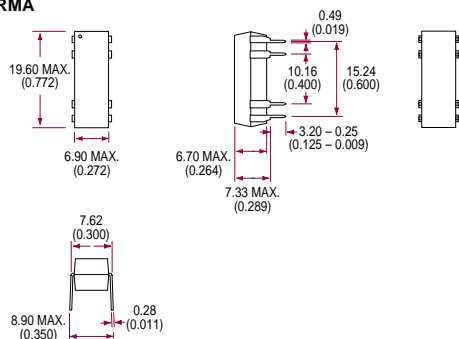

### PRMA 1A

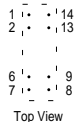

Top View

Options:  
Diode - pin #2 is positive  
Electrostatic shield - pin 9

### PRMA 1B

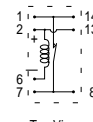

Top View

Options:  
Diode - pin #2 is positive  
Electrostatic shield - pin 9

### PRMA 1C

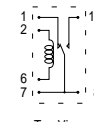

Top View

Options:  
Diode - pin #2 is positive  
Electrostatic shield - pin 9

### PRMA 2A

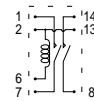

Top View

Options:  
Diode - pin #2 is positive  
Electrostatic shield - pin 9

### PRMA 10037/10038/10039

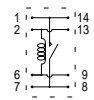

Top View

Options:  
Diode - pin #2 is positive  
Electrostatic shield - pin 9

### MVS2/MSS2

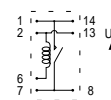

Top View

\* MVS2 only must be mounted vertically with pin #1 UP.

### PRME

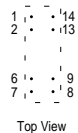
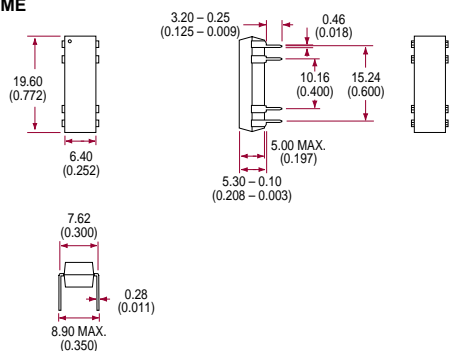

Top View

### PRME

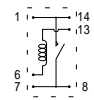

Top View

Options:  
Diode - pin #13 is positive  
Electrostatic shield - pin 9

### DSS7

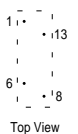
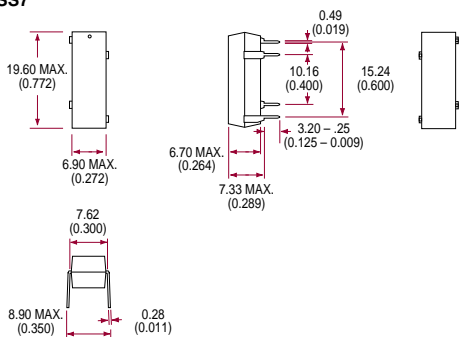

Top View

### DSS7



Top View

MVS must be mounted vertically. Pin #1 is up.



**ORDERING INFORMATION**

A complete part number is represented by the digits below. For example, the PRMA1A05 is a model 2 PRMA relay with a 1-Form A contact form, a nominal voltage of 5V and no extra options.

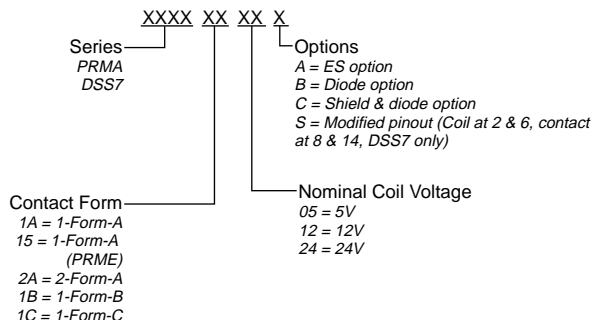

**Ordering Information  
Special Schematics**

PRME 25005  
 PRME 15005  
 PRME 15002  
 PRME 15003

PRMA 10037  
 PRMA 10038  
 PRMA 10039

*These represent full part numbers.*