

MAX16814

Integrated, 4-Channel, High-Brightness LED Driver with High-Voltage DC-DC Controller

General Description

The MAX16814 high-efficiency, high-brightness LED (HB LED) driver provides up to four integrated LED current-sink channels. An integrated current-mode switching DC-DC controller drives a DC-DC converter that provides the necessary voltage to multiple strings of HB LEDs. The MAX16814 accepts a wide 4.75V to 40V input voltage range and withstands direct automotive load-dump events. The wide input range allows powering HB LEDs for small to medium-sized LCD displays in automotive and general lighting applications.

An internal current-mode switching DC-DC controller supports the boost, coupled-inductor boost-buck, or SEPIC topologies and operates in an adjustable frequency range between 200kHz and 2MHz. It can also be used for single-inductor boost-buck topology in conjunction with the MAX15054 and an additional MOSFET. The current-mode control with programmable slope compensation provides fast response and simplifies loop compensation. The MAX16814 also features an adaptive output-voltage-control scheme that minimizes the power dissipation in the LED current-sink paths.

The MAX16814 consists of four identical linear current source channels to drive four strings of HB LEDs. The channel current is adjustable from 20mA to 150mA with an accuracy of $\pm 3\%$ using an external resistor. The external resistor sets all 4-channel currents to the same value. The device allows connecting multiple channels in parallel to achieve higher current per LED string. The MAX16814 also features pulsed dimming control on all four channels through a logic input (DIM). In addition, the MAX16814A_ _ and MAX16814U_ _ include a unique feature that allows a very short minimum pulse width as low as 1 μ s.

The MAX16814 includes output overvoltage, open-LED detection and protection, programmable shorted-LED detection and protection, and overtemperature protection. The device operates over the -40°C to $+125^{\circ}\text{C}$ automotive temperature range. The MAX16814 is available in 6.5mm x 4.4mm, 20-pin TSSOP, 4mm x 4mm, 20-pin TQFN and QFND packages.

Benefits and Features

- Cost-Effective 4-Channel Linear LED Current Sinks for Wide Range of LED Lighting Applications
 - Drives One to Four LED Strings
 - 4.75V to 40V Input Voltage Range
 - Full-Scale LED Current Adjustable from 20mA to 150mA
 - 5000:1 PWM Dimming at 200Hz
 - Less than 40 μ A Shutdown Current
- Minimal Component Count Saves Cost and Space
 - Internal MOSFET for Each Channel
 - Internal Current-Mode Switching DC-DC Controller Supporting Boost, Coupled-Inductor Boost-Buck, or SEPIC Topologies
 - 200kHz to 2MHz Programmable Switching Frequency for Optimizing Size vs. Efficiency
 - External Switching-Frequency Synchronization
- Protection Features and Wide Operating Temperature Range Improves Reliability
 - Open-Drain Fault-Indicator Output
 - Open-LED and LED-Short Detection and Protection
 - Overtemperature Protection
 - Available in Thermally Enhanced 20-Pin TQFN, QFND, and TSSOP Packages
 - Operation Over -40°C to $+125^{\circ}\text{C}$ Temperature Range

Applications

- Automotive Displays LED Backlights
- Automotive RCL, DRL, Front Position, and Fog Lights
- LCD TV and Desktop Display LED Backlights
- Architectural, Industrial, and Ambient Lighting

Typical Operating Circuit and Ordering Information appear at end of data sheet.

Absolute Maximum Ratings

IN to SGND.....-0.3V to +45V
 EN to SGND-0.3V to (VIN + 0.3V)
 PGND to SGND-0.3V to +0.3V
 LEDGND to SGND-0.3V to +0.3V
 OUT_ to LEDGND-0.3V to +45V
 VCC to SGND -0.3V to the lower of (VIN + 0.3V) and +6V
 DRV, FLT, DIM, RSDT, OVP to SGND.....-0.3V to +6V
 CS, RT, COMP, SET1 to SGND..... -0.3V to (VCC + 0.3V)
 NDRV to PGND-0.3V to (VDRV + 0.3V)
 NDRV Peak Current (< 100ns)..... ±3A
 NDRV Continuous Current ±100mA
 OUT_ Continuous Current ±175mA
 VCC Short-Circuit Duration Continuous

Continuous Power Dissipation (TA = +70°C) (Note 1)
 20-Pin TQFN (derate 25.6mW/°C above +70°C).....2051mW
 20-Pin Side-Wettable QFN
 (derate 26.5mW/°C above +70°C)2050mW
 26-Pin TSSOP (derate 26.5mW/°C above +70°C).....2122mW
 Operating Temperature Range
 MAX16814A_ _-40°C to +125°C
 MAX16814BE_ _ -40°C to +85°C
 MAX16814U_ _ and MAX16814BU_ _0°C to +85°C
 Junction Temperature+150°C
 Storage Temperature Range.....-65°C to +150°C
 Lead Temperature (soldering, 10s)+300°C
 Soldering Temperature (reflow)+260°C

Stresses beyond those listed under "Absolute Maximum Ratings" may cause permanent damage to the device. These are stress ratings only, and functional operation of the device at these or any other conditions beyond those indicated in the operational sections of the specifications is not implied. Exposure to absolute maximum rating conditions for extended periods may affect device reliability.

Package Thermal Characteristics (Note 1)

20 TQFN/QFN
 Junction-to-Ambient Thermal Resistance (θJA)..... +39°C/W
 Junction-to-Case Thermal Resistance (θJC)..... +6°C/W
 20 TSSOP
 Junction-to-Ambient Thermal Resistance (θJA)..... +37.7°C/W
 Junction-to-Case Thermal Resistance (θJC)..... +2.0°C/W

Note 1: Package thermal resistances were obtained using the method described in JEDEC specification JESD51-7, using a four-layer board. For detailed information on package thermal considerations, refer to <http://www.maximintegrated.com/thermal-tutorial>.

Electrical Characteristics

(VIN = VEN = 12V, RRT = 12.25kΩ, RSET1 = 15kΩ, CVCC = 1μF, VCC = VDRV, NDRV = COMP = OUT_ = unconnected, VRSDT = VDIM = VCC, VOVP = VCS = VLEDGND = VPGND = VSGND = 0V, TA = TJ = -40°C to +125°C for MAX16814A_ _, TA = -40°C to +85°C for MAX16814BE_ _, and TA = TJ = 0°C to +85°C for MAX16814U_ _ and MAX16814BU_ _, unless otherwise noted. Typical values are at TA = +25°C.) (Note 2)

PARAMETER	SYMBOL	CONDITIONS	MIN	TYP	MAX	UNITS
Operating Voltage Range	VIN		4.75		40	V
Active Supply Current	IIN	MAX16814A_ _ and MAX16814U_ _		2.5	5	mA
		MAX16814B_ _ _ only		2.75	5.5	
Standby Supply Current		VEN = 0V		15	40	μA
IN Undervoltage Lockout		VIN rising	3.975	4.3	4.625	V
IN UVLO Hysteresis				170		mV
VCC REGULATOR						
Regulator Output Voltage	VCC	6.5V < VIN < 10V, 1mA < ILOAD < 50mA	4.75	5.0	5.25	V
		10V < VIN < 40V, 1mA < ILOAD < 10mA				
Dropout Voltage		VIN - VCC, VIN = 4.75V, ILOAD = 50mA		200	500	mV
Short-Circuit Current Limit		VCC shorted to SGND		100		mA
VCC Undervoltage Lockout Threshold		VCC rising		4		V
VCC UVLO Hysteresis				100		mV
RT OSCILLATOR						
Switching Frequency Range	fsw		200		2000	kHz

Electrical Characteristics (continued)

($V_{IN} = V_{EN} = 12V$, $R_{RT} = 12.25k\Omega$, $R_{SET1} = 15k\Omega$, $C_{VCC} = 1\mu F$, $V_{CC} = V_{DRV}$, $NDRV = COMP = OUT_{-} =$ unconnected, $V_{RSDT} = V_{DIM} = V_{CC}$, $VOVP = V_{CS} = V_{LEDGND} = V_{PGND} = V_{SGND} = 0V$, $T_A = T_J = -40^{\circ}C$ to $+125^{\circ}C$ for MAX16814A_ _ , $T_A = -40^{\circ}C$ to $+85^{\circ}C$ for MAX16814BE_ _ , and $T_A = T_J = 0^{\circ}C$ to $+85^{\circ}C$ for MAX16814U_ _ and MAX16814BU_ _ , unless otherwise noted. Typical values are at $T_A = +25^{\circ}C$.) (Note 2)

PARAMETER	SYMBOL	CONDITIONS	MIN	TYP	MAX	UNITS
Maximum Duty Cycle		$f_{SW} = 200kHz$ to $600kHz$, MAX16814A_ _ and MAX16814U_ _	85	89	93	%
		$f_{SW} = 600kHz$ to $2000kHz$, MAX16814A_ _ and MAX16814U_ _	82	86	90	
		$f_{SW} = 200kHz$ to $600kHz$, MAX16814B_ _	90	94	98	
		$f_{SW} = 600kHz$ to $2000kHz$, MAX16814B_ _ _	86	90	94	
Oscillator Frequency Accuracy		$f_{SW} = 200kHz$ to $2MHz$, MAX16814A_ _ and MAX16814U_ _	-7.5		+7.5	%
		$f_{SW} = 200kHz$ to $2MHz$, MAX16814B_ _ _	-7		+7	
Sync Rising Threshold			4			V
Minimum Sync Frequency			1.1fsw			Hz
PWM COMPARATOR						
PWM Comparator Leading-Edge Blanking Time				60		ns
PWM to NDRV Propagation Delay		Including leading-edge blanking time		90		ns
SLOPE COMPENSATION						
Peak Slope Compensation Current Ramp Magnitude		Current ramp added to the CS input, MAX16814A_ _ only	44	49	54	$\mu A \times f_{SW}$
		Current ramp added to the CS input, MAX16814U_ _ and MAX16814B_ _ _	45	50	55	
CS LIMIT COMPARATOR						
Current-Limit Threshold		(Note 3)	396	416	437	mV
CS Limit Comparator to NDRV Propagation Delay		10mV overdrive, excluding leading-edge blanking time		10		ns
ERROR AMPLIFIER						
OUT_ Regulation Voltage				1		V
Transconductance	g_M		340	600	880	μS
No-Load Gain		(Note 4)		75		dB
COMP Sink Current		$V_{OUT_{-}} = 5V$, $V_{COMP} = 2.5V$	160	375	800	μA
COMP Source Current		$V_{OUT_{-}} = 0V$, $V_{COMP} = 2.5V$	160	375	800	μA
MOSFET DRIVER						
NDRV On-Resistance		$I_{SINK} = 100mA$ (nMOS)		0.9		Ω
		$I_{SOURCE} = 100mA$ (pMOS)		1.1		
Peak Sink Current		$V_{NDRV} = 5V$		2.0		A
Peak Source Current		$V_{NDRV} = 0V$		2.0		A
Rise Time		$C_{LOAD} = 1nF$		6		ns
Fall Time		$C_{LOAD} = 1nF$		6		ns
LED CURRENT SOURCES						
OUT_ Current-Sink Range		$V_{OUT_{-}} = V_{REF}$	20		150	mA
Channel-to-Channel Matching		$I_{OUT_{-}} = 100mA$			± 2	%
		$I_{OUT_{-}} = 100mA$, all channels on			± 1.5	

Electrical Characteristics (continued)

(VIN = VEN = 12V, RRT = 12.25kΩ, RSET1 = 15kΩ, CVCC = 1μF, VCC = VDRV, NDRV = COMP = OUT_ = unconnected, VRSDT = VDIM = VCC, VOVP = VCS = VLEDGND = VPGND = VSGND = 0V, TA = TJ = -40°C to +125°C for MAX16814A_ _ , TA = -40°C to +85°C for MAX16814BE_ _ , and TA = TJ = 0°C to +85°C for MAX16814U_ _ and MAX16814BU_ _ , unless otherwise noted. Typical values are at TA = +25°C.) (Note 2)

PARAMETER	SYMBOL	CONDITIONS	MIN	TYP	MAX	UNITS
Output Current Accuracy		I _{OUT_} = 100mA TA = +125°C, MAX16814A_ _ only			±3	%
		TA = -40°C to +125°C, MAX16814A_ _ only			±5	
	I _{OUT_} = 50mA to 150mA	TA = +25°C, MAX16814U_ _ and MAX16814B_ _ _			±2.75	
		TA = 0°C to +85°C, MAX16814U_ _ and MAX16814BU_ _			±4	
		TA = -40°C to +85°C for MAX16814BE_ _			±4	
OUT_ Leakage Current		VDIM = 0V, VOUT_ = 40V			1	μA
LOGIC INPUTS/OUTPUTS						
EN Reference Voltage		V _{EN} rising, MAX16814A_ _ only	1.125	1.23	1.335	V
		V _{EN} rising, MAX16814U_ _ and MAX16814B_ _ _	1.144	1.23	1.316	
EN Hysteresis				50		mV
EN Input Current		V _{EN} = 40V			±600	nA
DIM Input High Voltage			2.1			V
DIM Input Low Voltage					0.8	V
DIM Hysteresis				250		mV
DIM Input Current					±2	μA
DIM to LED Turn-On Delay		DIM rising edge to 10% rise in I _{OUT_}		100		ns
DIM to LED Turn-Off Delay		DIM falling edge to 10% fall in I _{OUT_}		100		ns
I _{OUT_} Rise and Fall Times				200		ns
FLT Output Low Voltage		V _{IN} = 4.75V and I _{SINK} = 5mA			0.4	V
FLT Output Leakage Current		V _{FLT} = 5.5V			1.0	μA
LED Short Detection Threshold		Gain = 3V	1.75	2.0	2.25	V
Short Detection Comparator Delay				6.5		μs
RSDT Leakage Current					±600	nA
OVP Trip Threshold		Output rising	1.19	1.228	1.266	V
OVP Hysteresis				70		mV
OVP Leakage Current		V _{OVP} = 1.25V			±200	nA
Thermal-Shutdown Threshold		Temperature rising		165		°C
Thermal-Shutdown Hysteresis				15		°C

Note 2: All MAX16814A_ _ are 100% tested at TA = +125°C, while all MAX16814U_ _ and MAX16814B_ _ _ are 100% tested at TA = +25°C. All limits overtemperature are guaranteed by design, not production tested.

Note 3: CS threshold includes slope-compensation ramp magnitude.

Note 4: Gain = ΔV_{COMP}/ΔV_{CS}, 0.05V < V_{CS} < 0.15V.

Typical Operating Characteristics

(VIN = VEN = 12V, fsw = 300kHz, RSET1 = 15kΩ, CVCC = 1μF, VCC = VDRV, NDRV = COMP = OUT_ = unconnected, VOVP = VCS = VLEDGND = VDIM = VPGND = VSGND = 0V, load = 4 strings of 7 white LEDs, TA = +25°C, unless otherwise noted.)

SWITCHING WAVEFORM AT 5kHz
(50% DUTY CYCLE) DIMMING

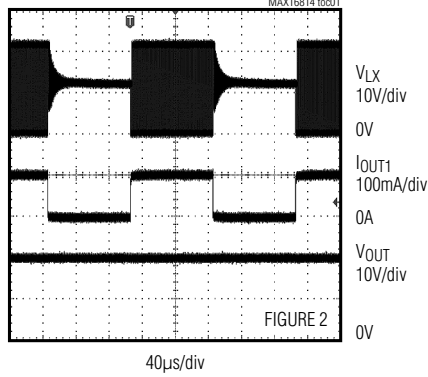

SUPPLY CURRENT vs. SUPPLY VOLTAGE

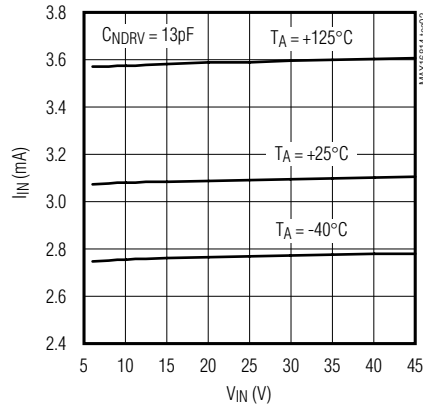

SUPPLY CURRENT vs. SWITCHING FREQUENCY

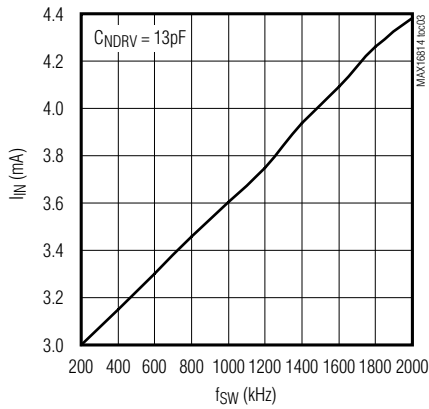

SWITCHING FREQUENCY vs. TEMPERATURE

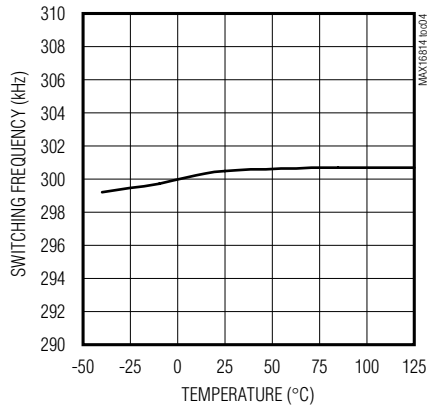

VSET1 vs. TEMPERATURE

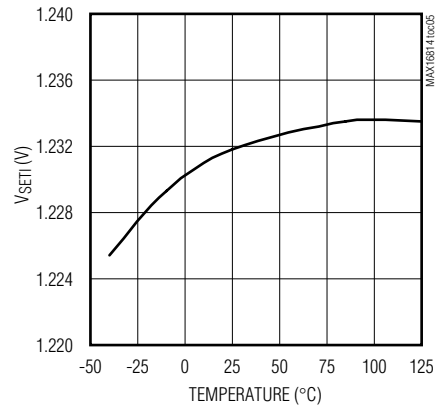

VSET1 vs. PROGRAMMED CURRENT

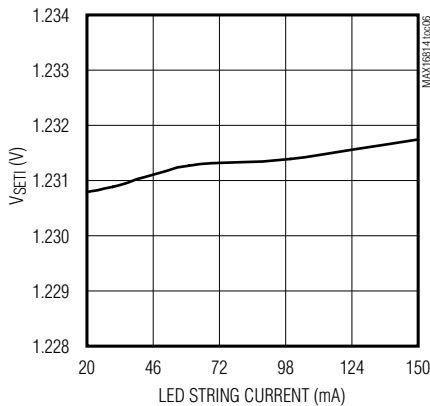

EN THRESHOLD VOLTAGE vs. TEMPERATURE

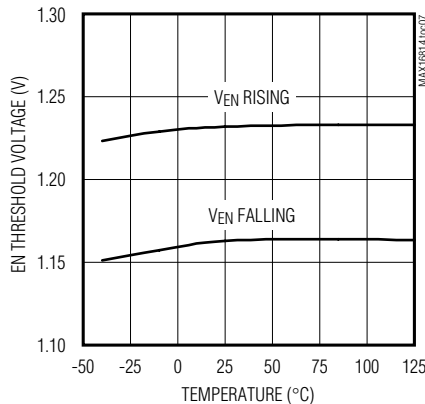

EN LEAKAGE CURRENT vs. TEMPERATURE

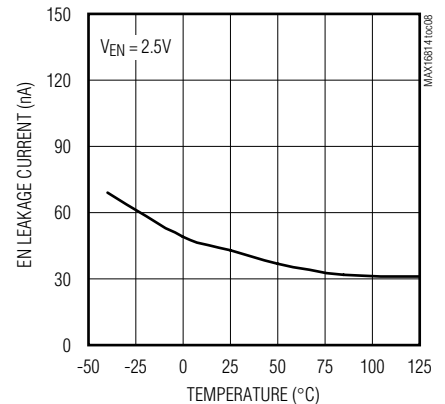

Typical Operating Characteristics (continued)

(VIN = VEN = 12V, fsw = 300kHz, RSET1 = 15kΩ, CVCC = 1μF, VCC = VDRV, NDRV = COMP = OUT_ = unconnected, VOVP = VCS = VLEDGND = VDIM = VPGND = VSGND = 0V, load = 4 strings of 7 white LEDs, TA = +25°C, unless otherwise noted.)

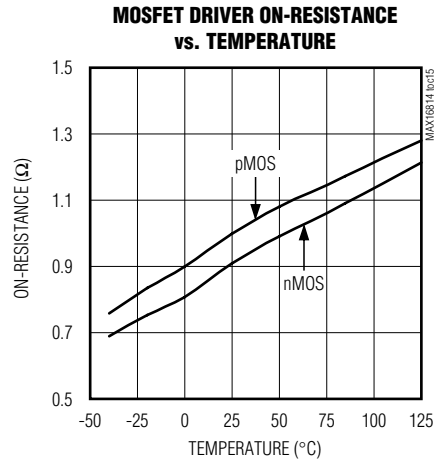
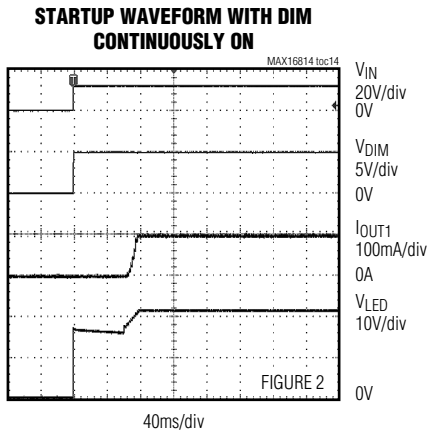
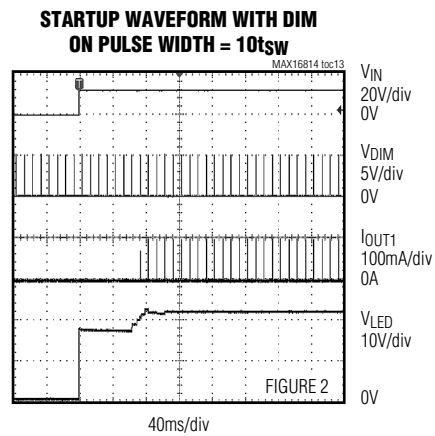
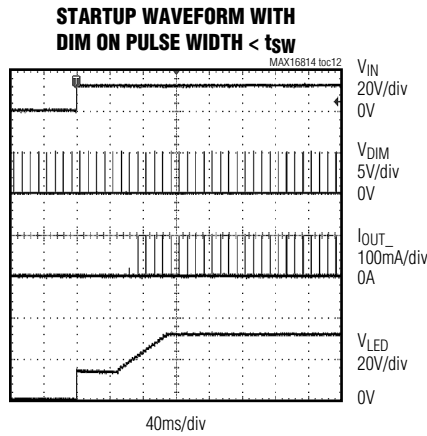
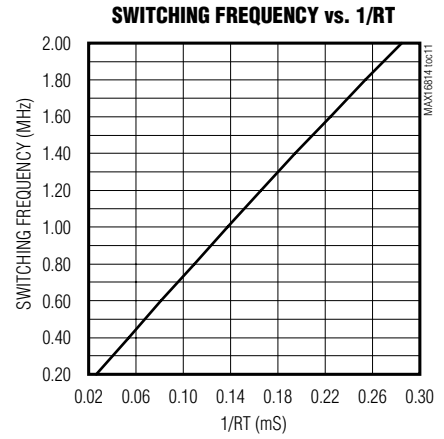
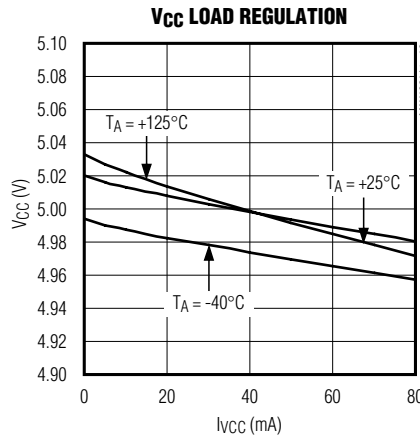
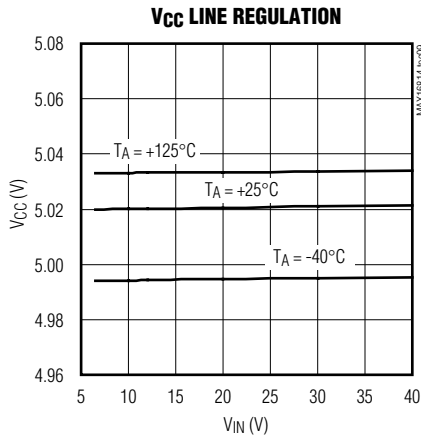

Typical Operating Characteristics (continued)

(VIN = VEN = 12V, fsw = 300kHz, RSET1 = 15kΩ, CVCC = 1μF, VCC = VDRV, NDRV = COMP = OUT_ = unconnected, VOVP = VCS = VLEDGND = VDIM = VPGND = VSGND = 0V, load = 4 strings of 7 white LEDs, TA = +25°C, unless otherwise noted.)

LED CURRENT SWITCHING WITH DIM AT 5kHz AND 50% DUTY CYCLE

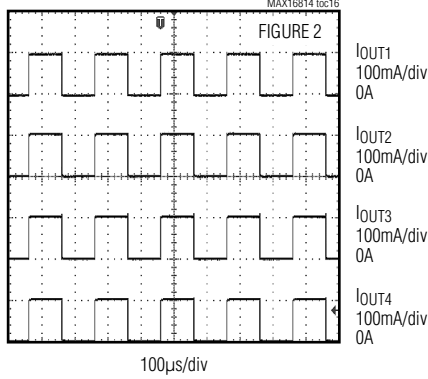

LED CURRENT RISING AND FALLING WAVEFORM

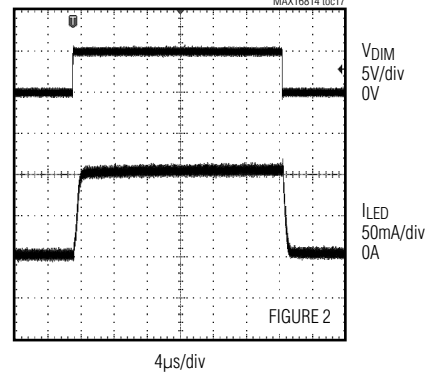

OUT_ CURRENT vs. 1/RSET1

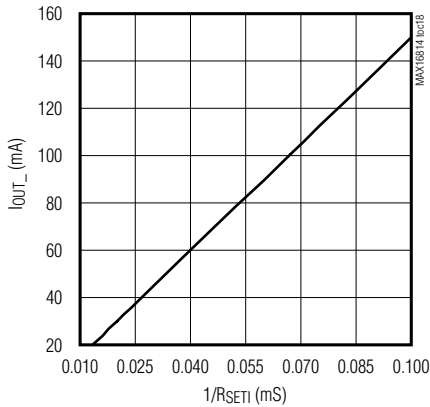

COMP LEAKAGE CURRENT vs. TEMPERATURE

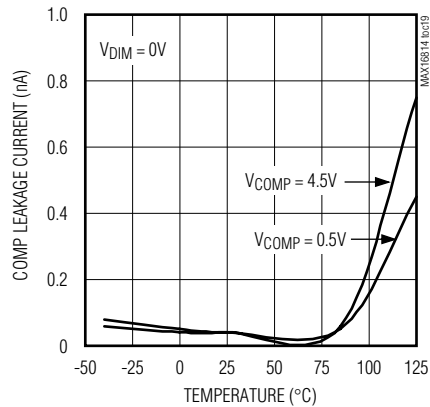

OUT_ LEAKAGE CURRENT vs. TEMPERATURE

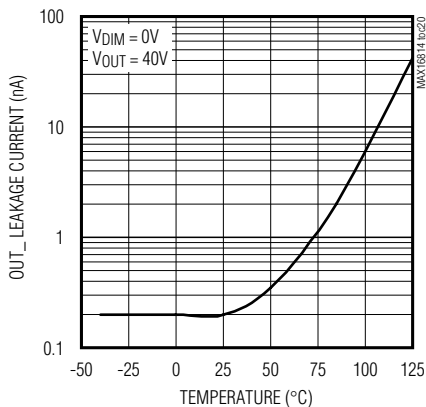

OVP LEAKAGE CURRENT vs. TEMPERATURE

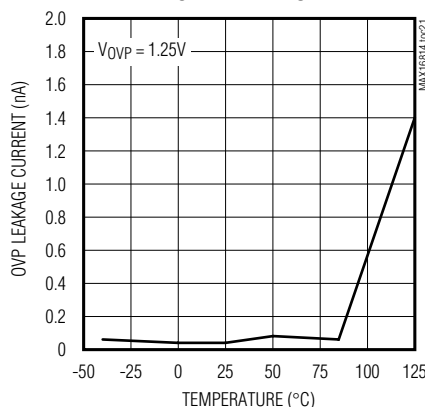

RSMT LEAKAGE CURRENT vs. TEMPERATURE

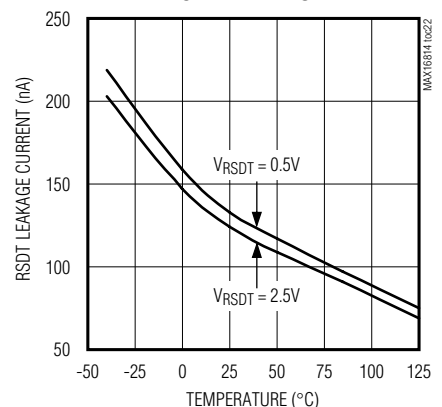

Pin Configurations

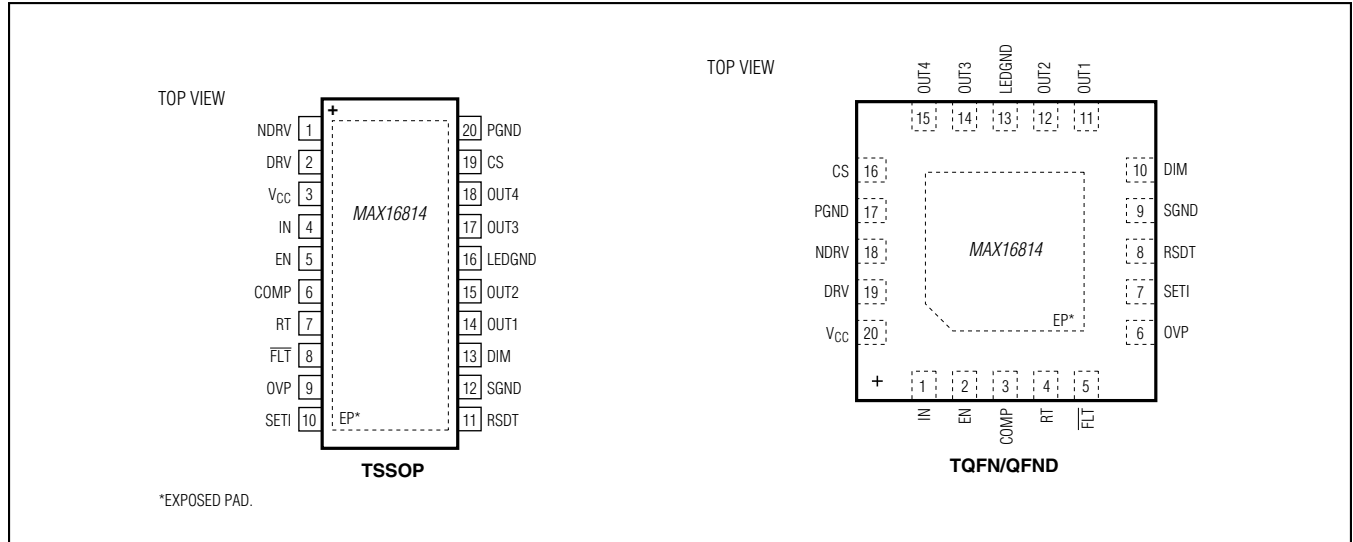

Pin Description

PIN		NAME	FUNCTION
TQFN/QFN	TSSOP		
1	4	IN	Bias Supply Input. Connect a 4.75V to 40V supply to IN. Bypass IN to SGND with a ceramic capacitor.
2	5	EN	Enable Input. Connect EN to logic-low to shut down the device. Connect EN to logic-high or IN for normal operation. The EN logic threshold is internally set to 1.23V.
3	6	COMP	Switching Converter Compensation Input. Connect the compensation network from COMP to SGND for current-mode control (see the <i>Feedback Compensation</i> section).
4	7	RT	Oscillator Timing Resistor Connection. Connect a timing resistor (RT) from RT to SGND to program the switching frequency according to the formula $RT = 7.350 \times 10^9 / f_{sw}$ (for the MAX16814A__ and the MAX16814U__) or to the formula $RT = 7.72 \times 10^9 / f_{sw}$ (for the MAX16814B__). Apply an AC-coupled external clock at RT to synchronize the switching frequency with an external clock.
5	8	FLT	Open-Drain Fault Output. FLT asserts low when an open LED, short LED, or thermal shutdown is detected. Connect a 10kΩ pullup resistor from FLT to VCC.
6	9	OVP	Overvoltage-Threshold-Adjust Input. Connect a resistor-divider from the switching converter output to OVP and SGND. The OVP comparator reference is internally set to 1.23V.
7	10	SETI	LED Current-Adjust Input. Connect a resistor (RSETI) from SETI to SGND to set the current through each LED string (ILED) according to the formula $I_{LED} = 1500/R_{SETI}$.
8	11	RSdT	LED Short Detection Threshold Adjust Input. Connect a resistive divider from VCC to RSdT and SGND to program the LED short detection threshold. Connect RSdT directly to VCC to disable LED short detection. The LED short detection comparator is internally referenced to 2V.
9	12	SGND	Signal Ground. SGND is the current return path connection for the low-noise analog signals. Connect SGND, LEDGND, and PGND at a single point.

Pin Description (continued)

PIN		NAME	FUNCTION
TQFN/ QFND	TSSOP		
10	13	DIM	Digital PWM Dimming Input. Apply a PWM signal to DIM for LED dimming control. Connect DIM to V _{CC} if dimming control is not used.
11	14	OUT1	LED String Cathode Connection 1. OUT1 is the open-drain output of the linear current sink that controls the current through the LED string connected to OUT1. OUT1 sinks up to 150mA. If unused, connect OUT1 to LEDGND.
12	15	OUT2	LED String Cathode Connection 2. OUT2 is the open-drain output of the linear current sink that controls the current through the LED string connected to OUT2. OUT2 sinks up to 150mA. If unused, connect OUT2 to LEDGND.
13	16	LEDGND	LED Ground. LEDGND is the return path connection for the linear current sinks. Connect SGND, LEDGND, and PGND at a single point.
14	17	OUT3	LED String Cathode Connection 3. OUT3 is the open-drain output of the linear current sink that controls the current through the LED string connected to OUT3. OUT3 sinks up to 150mA. If unused, connect OUT3 to LEDGND.
15	18	OUT4	LED String Cathode Connection 4. OUT4 is the open-drain output of the linear current sink that controls the current through the LED string connected to OUT4. OUT4 sinks up to 150mA. If unused, connect OUT4 to LEDGND.
16	19	CS	Current-Sense Input. CS is the current-sense input for the switching regulator. A sense resistor connected from the source of the external power MOSFET to PGND sets the switching current limit. A resistor connected between the source of the power MOSFET and CS sets the slope compensation ramp rate (see the <i>Slope Compensation</i> section).
17	20	PGND	Power Ground. PGND is the switching current return path connection. Connect SGND, LEDGND, and PGND at a single point.
18	1	NDRV	Switching n-MOSFET Gate-Driver Output. Connect NDRV to the gate of the external switching power MOSFET.
19	2	DRV	MOSFET Gate-Driver Supply Input. Connect a resistor between V _{CC} and DRV to power the MOSFET driver with the internal 5V regulator. Bypass DRV to PGND with a minimum of 0.1μF ceramic capacitor.
20	3	VCC	5V Regulator Output. Bypass V _{CC} to SGND with a minimum of 1μF ceramic capacitor as close as possible to the device.
—	—	EP	Exposed Pad. Connect EP to a large-area contiguous copper ground plane for effective power dissipation. Do not use as the main IC ground connection. EP must be connected to SGND.

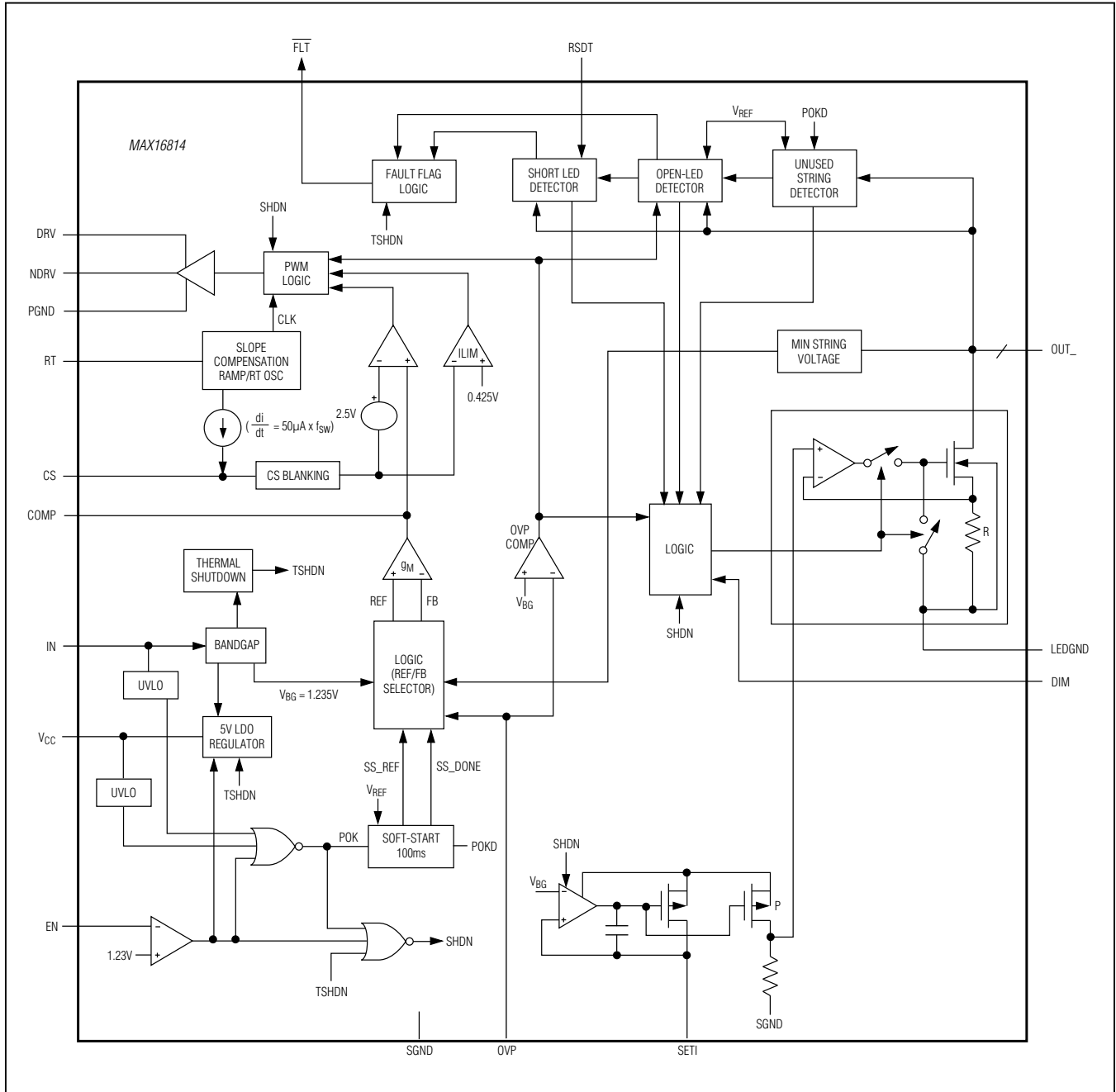

Figure 1. Simplified Functional Diagram

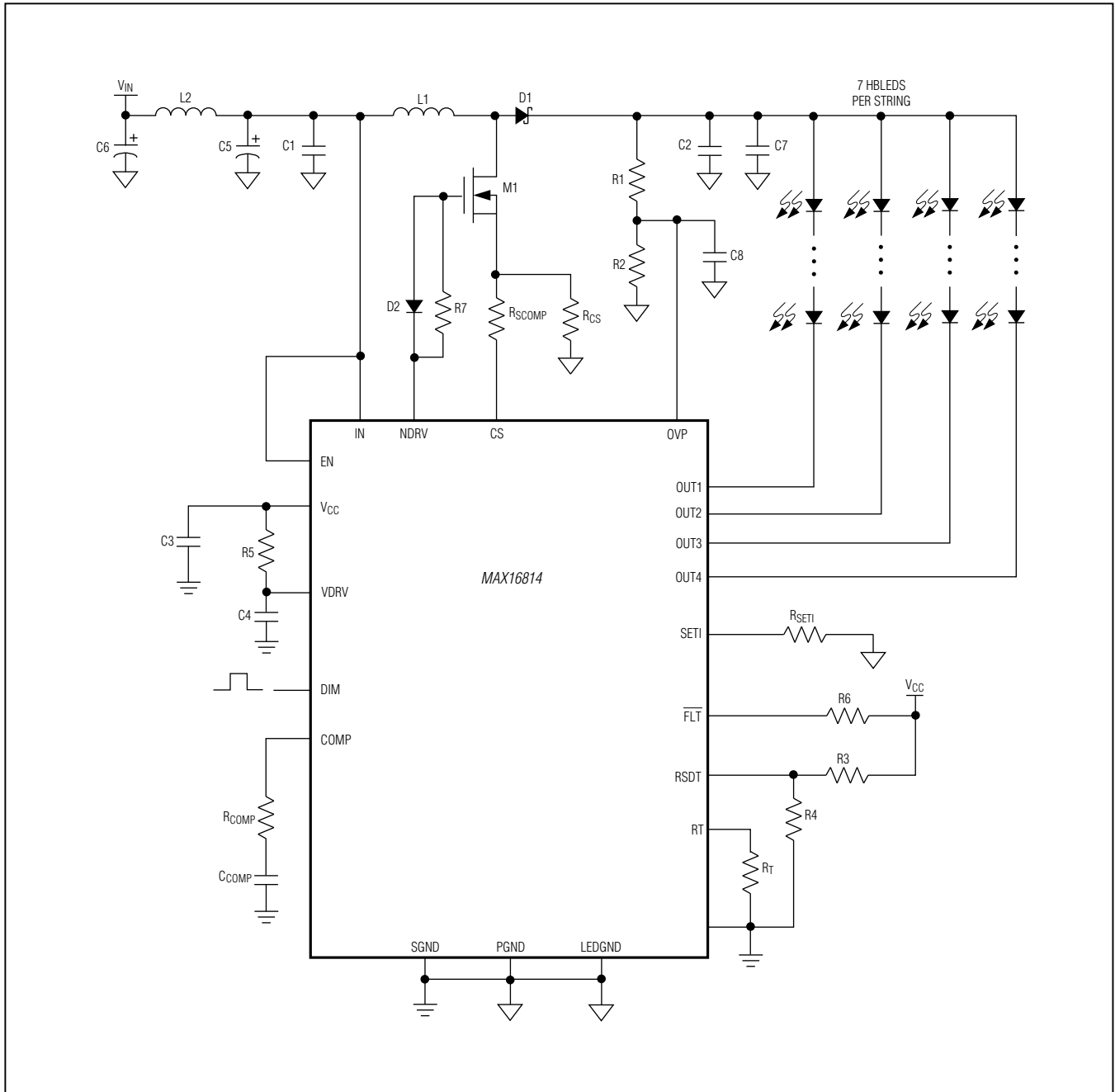

Figure 2. Circuit Used for Typical Operating Characteristics

Detailed Description

The MAX16814 high-efficiency HB LED driver integrates all the necessary features to implement a high-performance backlight driver to power LEDs in small to medium-sized displays for automotive as well as general applications. The device provides load-dump voltage protection up to 40V in automotive applications. The MAX16814 incorporates two major blocks: a DC-DC controller with peak current-mode control to implement a boost, coupled-inductor boost-buck, or a SEPIC-type switched-mode power supply and a 4-channel LED driver with 20mA to 150mA constant current-sink capability per channel. [Figure 1](#) is the simplified functional diagram and [Figure 2](#) shows the circuit used for typical operating characteristics.

The MAX16814 features a constant-frequency peak current-mode control with programmable slope compensation to control the duty cycle of the PWM controller. The high-current FET driver can provide up to 2A of current to the external n-channel MOSFET. The DC-DC converter implemented using the controller generates the required supply voltage for the LED strings from a wide input supply range. Connect LED strings from the DC-DC converter output to the 4-channel constant current-sink drivers that control the current through the LED strings. A single resistor connected from the SET1 input to ground adjusts the forward current through all four LED strings.

The MAX16814 features adaptive voltage control that adjusts the converter output voltage depending on the forward voltage of the LED strings. This feature minimizes the voltage drop across the constant current-sink drivers and reduces power dissipation in the device. A logic input (EN) shuts down the device when pulled low. The device includes an internal 5V LDO capable of powering additional external circuitry.

All the versions of the MAX16814 include PWM dimming. The MAX16814A_ and the MAX16814U_ versions, in particular, provide very wide (5000:1) PWM dimming range where a dimming pulse as narrow as 1 μ s is possible at a 200Hz dimming frequency. This is made possible by a unique feature that detects short PWM dimming input pulses and adjusts the converter feedback accordingly.

Advanced features include detection and string-disconnect for open-LED strings, partial or fully shorted strings, and unused strings. Overvoltage protection clamps the converter output voltage to the programmed OVP threshold in the event of an open-LED condition. Shorted LED string detection and overvoltage

protection thresholds are programmable using RSDT and OVP inputs, respectively. An open-drain $\overline{\text{FLT}}$ signal asserts to indicate open-LED, shorted-LED, and over-temperature conditions. Disable individual current-sink channels by connecting the corresponding OUT_ to LEDGND. In this case, $\overline{\text{FLT}}$ does not assert indicating an open-LED condition for the disabled channel. The device also features an overtemperature protection that shuts down the controller if the die temperature exceeds +165°C.

Current-Mode DC-DC Controller

The peak current-mode controller allows boost, coupled-inductor buck-boost, or SEPIC-type converters to generate the required bias voltage for the LED strings. The switching frequency can be programmed over the 200kHz to 2MHz range using a resistor connected from RT to SGND. Programmable slope compensation is available to compensate for subharmonic oscillations that occur at above 50% duty cycles in continuous-conduction mode.

The external MOSFET is turned on at the beginning of every switching cycle. The inductor current ramps up linearly until it is turned off at the peak current level set by the feedback loop. The peak inductor current is sensed from the voltage across the current-sense resistor (RCS) connected from the source of the external MOSFET to PGND. The MAX16814 features leading-edge blanking to suppress the external MOSFET switching noise. A PWM comparator compares the current-sense voltage plus the slope-compensation signal with the output of the transconductance error amplifier. The controller turns off the external MOSFET when the voltage at CS exceeds the error amplifier's output voltage. This process repeats every switching cycle to achieve peak current-mode control.

Error Amplifier

The internal error amplifier compares an internal feedback (FB) with an internal reference (REF) and regulates its output to adjust the inductor current. An internal minimum string detector measures the minimum current-sink voltage with respect to SGND out of the four constant-current-sink channels. During normal operation, this minimum OUT_ voltage is regulated to 1V through feedback. The error amplifier takes 1V as the REF and the minimum OUT_ voltage as the FB input. The amplified error at the COMP output controls the inductor peak current to regulate the minimum OUT_ voltage at 1V. The resulting DC-DC converter output voltage is the highest LED string voltage plus 1V.

The converter stops switching when the LED strings are turned off during PWM dimming. The error amplifier is

disconnected from the COMP output to retain the compensation capacitor charge. This allows the converter to settle to steady-state level almost immediately when the LED strings are turned on again. This unique feature provides fast dimming response, without having to use large output capacitors.

For the MAX16814A_ _ and the MAX16814U_ _, if the PWM dimming on-pulse is less than or equal to five switching cycles, the feedback controls the voltage on OVP so that the converter output voltage is regulated at 95% of the OVP threshold. This mode ensures that narrow PWM dimming pulses are not affected by the response time of the converter. During this mode, the error amplifier remains connected to the COMP output continuously and the DC-DC converter continues switching.

Undervoltage Lockout (UVLO)

The MAX16814 features two undervoltage lockouts that monitor the input voltage at IN and the output of the internal LDO regulator at V_{CC}. The device turns on after both V_{IN} and V_{CC} exceed their respective UVLO thresholds. The UVLO threshold at IN is 4.3V when V_{IN} is rising and 4.15V when V_{IN} is falling. The UVLO threshold at V_{CC} is 4V when V_{CC} is rising and 3.9V when V_{CC} is falling.

Enable

EN is a logic input that completely shuts down the device when connected to logic-low, reducing the current consumption of the device to less than 40μA. The logic threshold at EN is 1.23V (typ). The voltage at EN must exceed 1.23V before any operation can commence. There is a 50mV hysteresis on EN. The EN input also allows programming the supply input UVLO threshold using an external voltage-divider to sense the input voltage as shown below.

Use the following equation to calculate the value of R1 and R2 in [Figure 3](#):

$$R1 = \left(\frac{V_{UVLO}}{1.23V} - 1 \right) \times R2$$

where V_{UVLO} is the desired undervoltage lockout level and 1.23V is the EN input reference. Connect EN to IN if not used.

Soft-Start

The MAX16814 provides soft-start with internally set timing. At power-up, the MAX16814 enters soft-start once unused LED strings are detected and disconnected (see the *Open-LED Management and Overvoltage Protection* section). During soft-start, the DC-DC converter output ramps towards

95% of the OVP voltage and uses feedback from the OVP input. Soft-start terminates when the minimum current-sink voltage reaches 1V or when the converter output reaches 95% OVP. The typical soft-start period is 100ms. The 1V minimum OUT_ voltage is detected only when the LED strings are enabled by PWM dimming. Connect OVP to the boost converter output through a resistive divider network (see the *Typical Operating Circuit*).

When there is an open-LED condition, the converter output hits the OVP threshold. After the OVP is triggered, open-LED strings are disconnected and, at the beginning of the dimming PWM pulse, control is transferred to the adaptive voltage control. The converter output discharges to a level where the new minimum OUT_ voltage is 1V.

Oscillator Frequency/External Synchronization

The internal oscillator frequency is programmable between 200kHz and 2MHz using a resistor (R_T) connected from the RT input to SGND. Use the equation below to calculate the value of R_T for the desired switching frequency, f_{SW}.

$$R_T = \frac{7.35 \times 10^9 \text{ Hz}}{f_{SW}}$$

(for the MAX16814A_ _ and the MAX16814U_ _).

$$R_T = \frac{7.72 \times 10^9}{f_{SW}}$$

(for the MAX16814B_ _ _).

Synchronize the oscillator with an external clock by AC-coupling the external clock to the RT input. The capacitor used for the AC-coupling should satisfy the following relation:

$$C_{SYNC} \leq \left(\frac{9.862}{R_T} - 0.144 \times 10^{-3} \right) (\mu\text{F})$$

where R_T is in Ω.

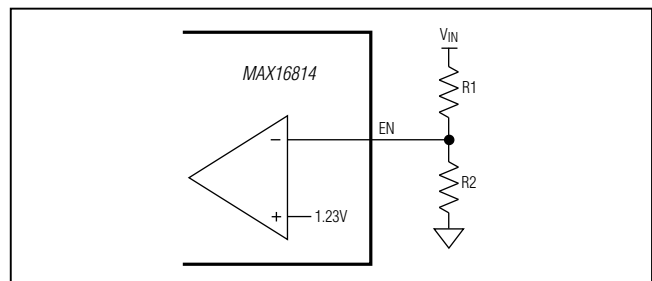

Figure 3. Setting the MAX16814 Undervoltage Lockout Threshold

The pulse width for the synchronization pulse should satisfy the following relations:

$$\frac{t_{PW}}{t_{CLK}} V_S < 0.5$$

$$\left(0.8 - \frac{t_{PW}}{t_{CLK}} V_S\right) + V_S > 3.4$$

$$t_{PW} < \frac{t_{CLK}}{t_{CI}} (t_{CI} - 1.05 \times t_{CLK})$$

where t_{PW} is the synchronization source pulse width, t_{CLK} is the synchronization clock time period, t_{CI} is the programmed clock period, and V_S is the synchronization pulse voltage level.

5V LDO Regulator (Vcc)

The internal LDO regulator converts the input voltage at IN to a 5V output voltage at VCC. The LDO regulator supplies up to 50mA current to provide power to internal control circuitry and the gate driver. Connect a resistor between VCC and DRV to power the gate-drive circuitry; the recommended value is 4.7Ω. Bypass DRV with a capacitor to PGND. The external resistor and bypass capacitor provide noise filtering. Bypass VCC to SGND with a minimum of 1μF ceramic capacitor as close to the device as possible.

PWM MOSFET Driver

The NDRV output is a push-pull output with the on-resistance of the pMOS typically 1.1Ω and the on-resistance of the nMOS typically 0.9Ω. NDRV swings from PGND to DRV to drive an external n-channel MOSFET. The driver typically sources 2.0A and sinks 2.0A allowing for fast turn-on and turn-off of high gate-charge MOSFETs.

The power dissipation in the MAX16814 is mainly a function of the average current sourced to drive the external MOSFET (IDRV) if there are no additional loads on VCC. IDRV depends on the total gate charge (QG) and operating frequency of the converter. Connect DRV to VCC with a 4.7Ω resistor to power the gate driver with the internal 5V regulator.

LED Current Control

The MAX16814 features four identical constant-current sources used to drive multiple HB LED strings. The current through each one of the four channels is adjustable between 20mA and 150mA using an external resistor (RSETI) connected between SETI and SGND. Select RSETI using the following formula:

$$R_{SETI} = 1500/I_{OUT_}$$

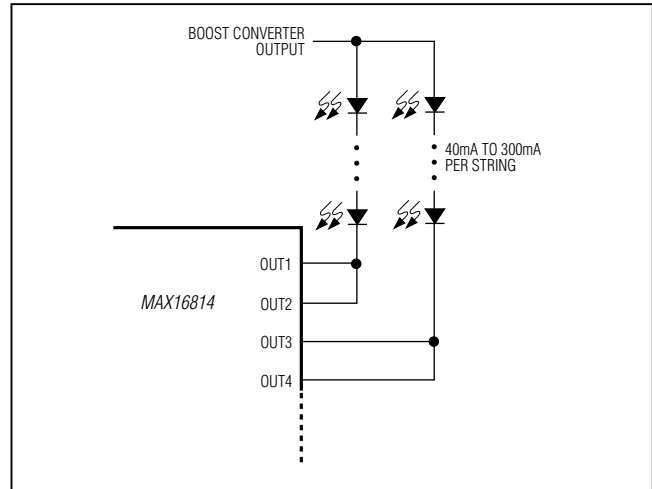

Figure 4. Configuration for Higher LED String Current

where $I_{OUT_}$ is the desired output current for each of the four channels.

If more than 150mA is required in an LED string, use two or more of the current source outputs (OUT_) connected together to drive the string as shown in [Figure 4](#).

LED Dimming Control

The MAX16814 features LED brightness control using an external PWM signal applied at DIM. A logic-high signal on the DIM input enables all four LED current sources and a logic-low signal disables them.

For the MAX16814A_ and the MAX16814U_ , the duty cycle of the PWM signal applied to DIM also controls the DC-DC converter's output voltage. If the turn-on duration of the PWM signal is less than or equal to 5 oscillator clock cycles (DIM pulse width decreasing) then the boost converter regulates its output based on feedback from the OVP input. During this mode, the converter output voltage is regulated to 95% of the OVP threshold voltage. If the turn-on duration of the PWM signal is greater than or equal to 6 oscillator clock cycles (DIM pulse width increasing), then the converter regulates its output so that the minimum voltage at OUT_ is 1V.

When the DIM signal crosses the 5 or 6 oscillator clock-cycle boundary, the control loop of the MAX16814 experiences a discontinuity due to an internal mode transition, which can cause flickering (the boost output voltage changes, as described in previous paragraph). To avoid flicker, the following is recommended:

- Avoid crossing the 5 or 6 oscillator clock-cycle boundary.

- Do not set the OVP level higher than 3V above the maximum LED operating voltage.
- Optimize the compensation components so that recovery is as fast as possible. If the loop phase margin is less than 45°, the output voltage may ring during the 5 or 6 oscillator clock-cycle boundary crossing, which can contribute to flicker.

Fault Protections

Fault protections in the MAX16814 include cycle-by-cycle current limiting using the PWM controller, DC-DC converter output overvoltage protection, open-LED detection, short LED detection and protection, and overtemperature shutdown. An open-drain LED fault flag output ($\overline{\text{FLT}}$) goes low when an open-LED string is detected, a shorted LED string is detected, and during thermal shutdown. $\overline{\text{FLT}}$ is cleared when the fault condition is removed during thermal shutdown and shorted LEDs. $\overline{\text{FLT}}$ is latched low for an open-LED condition and can be reset by cycling power or toggling the EN pin. The thermal shutdown threshold is +165°C and has 15°C hysteresis.

Open-LED Management and Overvoltage Protection

On power-up, the MAX16814 detects and disconnects any unused current-sink channels before entering soft-start. Disable the unused current-sink channels by connecting the corresponding OUT_- to LEDGND. This avoids asserting the $\overline{\text{FLT}}$ output for the unused channels. After soft-start, the MAX16814 detects open LED and disconnects any strings with an open LED from the internal minimum OUT_- voltage detector. This keeps the DC-DC converter output voltage within safe limits and maintains high efficiency. During normal operation, the DC-DC converter output regulation loop uses the minimum OUT_- voltage as the feedback input. If any LED string is open, the voltage at the opened OUT_- goes to VLEDGND. The DC-DC converter output voltage then increases to the overvoltage protection threshold set by the voltage-divider network connected between the converter output, OVP input, SGND. The overvoltage protection threshold at the DC-DC converter output (V_{OVP}) is determined using the following formula:

$$V_{\text{OVP}} = 1.23 \times \left(1 + \frac{R1}{R2} \right) \quad (\text{see the } \textit{Typical Operating Circuit})$$

where 1.23V (typ) is the OVP threshold. Select R1 and R2 such that the voltage at OUT_- does not exceed the absolute maximum rating. As soon as the DC-DC

converter output reaches the overvoltage protection threshold, the PWM controller is switched off, setting NDRV low. Any current-sink output with $V_{\text{OUT}_-} < 300\text{mV}$ (typ) is disconnected from the minimum voltage detector.

Connect the OUT_- of all channels without LED connections to LEDGND before power-up to avoid OVP triggering at startup. When an open-LED overvoltage condition occurs, $\overline{\text{FLT}}$ is latched low.

Short-LED Detection

The MAX16814 checks for shorted LEDs at each rising edge of DIM. An LED short is detected at OUT_- if the following condition is met:

$$V_{\text{OUT}_-} > V_{\text{MINSTR}} + 3 \times V_{\text{RSDT}}$$

where V_{OUT_-} is the voltage at OUT_- , V_{MINSTR} is the minimum current-sink voltage, and V_{RSDT} is the programmable LED short detection threshold set at the RSdT input. Adjust V_{RSDT} using a voltage-divider resistive network connected at the VCC output, RSdT input, and SGND.

Once a short is detected on any of the strings, the LED strings with the short are disconnected and the $\overline{\text{FLT}}$ output flag asserts until the device detects that the shorts are removed on any of the following rising edges of DIM. Connect RSdT directly to VCC to always disable LED short detection.

Applications Information

DC-DC Converter

Three different converter topologies are possible with the DC-DC controller in the MAX16814, which has the ground-referenced outputs necessary to use the constant current-sink drivers. If the LED string forward voltage is always more than the input supply voltage range, use the boost converter topology. If the LED string forward voltage falls within the supply voltage range, use the boost-buck converter topology. Boost-buck topology is implemented using either a conventional SEPIC configuration or a coupled-inductor boost-buck configuration. The latter is basically a flyback converter with 1:1 turns ratio. 1:1 coupled inductors are available with tight coupling suitable for this application. [Figure 6](#) shows the coupled-inductor boost-buck configuration. It is also possible to implement a single inductor boost-buck converter using the MAX15054 high-side FET driver.

The boost converter topology provides the highest efficiency among the above mentioned topologies. The coupled-inductor boost-buck topology has the advan-

tage of not using a coupling capacitor over the SEPIC configuration. Also, the feedback loop compensation for SEPIC becomes complex if the coupling capacitor is not large enough. A coupled-inductor boost-buck is not suitable for cases where the coupled-inductor windings are not tightly coupled. Considerable leakage inductance requires additional snubber components and degrades the efficiency.

Power-Circuit Design

First select a converter topology based on the previous factors. Determine the required input-supply voltage range, the maximum voltage needed to drive the LED strings including the minimum 1V across the constant LED current sink (V_{LED}), and the total output current needed to drive the LED strings (I_{LED}) as follows:

$$I_{LED} = I_{STRING} \times N_{STRING}$$

where I_{STRING} is the LED current per string in amperes and N_{STRING} is the number of strings used.

Calculate the maximum duty cycle (D_{MAX}) using the following equations:

For boost configuration:

$$D_{MAX} = \frac{(V_{LED} + V_{D1} - V_{IN_MIN})}{(V_{LED} + V_{D1} - V_{DS} - 0.3V)}$$

For SEPIC and coupled-inductor boost-buck configurations:

$$D_{MAX} = \frac{(V_{LED} + V_{D1})}{(V_{IN_MIN} - V_{DS} - 0.3V + V_{LED} + V_{D1})}$$

where V_{D1} is the forward drop of the rectifier diode in volts (approximately 0.6V), V_{IN_MIN} is the minimum input supply voltage in volts, and V_{DS} is the drain-to-source voltage of the external MOSFET in volts when it is on, and 0.3V is the peak current-sense voltage. Initially, use an approximate value of 0.2V for V_{DS} to calculate D_{MAX} . Calculate a more accurate value of D_{MAX} after the power MOSFET is selected based on the maximum inductor current. Select the switching frequency (f_{SW}) depending on the space, noise, and efficiency constraints.

Inductor Selection

Boost and Coupled-Inductor Boost-Buck Configurations

In all the three converter configurations, the average inductor current varies with the line voltage and the

maximum average current occurs at the lowest line voltage. For the boost converter, the average inductor current is equal to the input current. Select the maximum peak-to-peak ripple on the inductor current (ΔI_L). The recommended peak-to-peak ripple is 60% of the average inductor current.

Use the following equations to calculate the maximum average inductor current (I_{L_AVG}) and peak inductor current (I_{L_P}) in amperes:

$$I_{L_AVG} = \frac{I_{LED}}{1 - D_{MAX}}$$

Allowing the peak-to-peak inductor ripple ΔI_L to be $\pm 30\%$ of the average inductor current:

$$\Delta I_L = I_{L_AVG} \times 0.3 \times 2$$

and:

$$I_{L_P} = I_{L_AVG} + \frac{\Delta I_L}{2}$$

Calculate the minimum inductance value, L_{MIN} , in henries with the inductor current ripple set to the maximum value:

$$L_{MIN} = \frac{(V_{IN_MIN} - V_{DS} - 0.3V) \times D_{MAX}}{f_{SW} \times \Delta I_L}$$

where 0.3V is the peak current-sense voltage. Choose an inductor that has a minimum inductance greater than the calculated L_{MIN} and current rating greater than I_{L_P} . The recommended saturation current limit of the selected inductor is 10% higher than the inductor peak current for boost configuration. For the coupled-inductor boost-buck, the saturation limit of the inductor with only one winding conducting should be 10% higher than I_{L_P} .

SEPIC Configuration

Power circuit design for the SEPIC configuration is very similar to a conventional boost-buck design with the output voltage referenced to the input supply voltage. For SEPIC, the output is referenced to ground and the inductor is split into two parts (see [Figure 5](#) for the SEPIC configuration). One of the inductors (L_2) takes LED current as the average current and the other (L_1) takes input current as the average current.

Use the following equations to calculate the average inductor currents (I_{L1AVG} , I_{L2AVG}) and peak inductor currents (I_{L1P} , I_{L2P}) in amperes:

$$I_{L1AVG} = \frac{I_{LED} \times D_{MAX} \times 1.1}{1 - D_{MAX}}$$

The factor 1.1 provides a 10% margin to account for the converter losses:

$$I_{L2AVG} = I_{LED}$$

Assuming the peak-to-peak inductor ripple ΔI_L is $\pm 30\%$ of the average inductor current:

$$\Delta I_{L1} = I_{L1AVG} \times 0.3 \times 2$$

and:

$$I_{L1P} = I_{L1AVG} + \frac{\Delta I_{L1}}{2}$$

$$\Delta I_{L2} = I_{L2AVG} \times 0.3 \times 2$$

and:

$$I_{L2P} = I_{L2AVG} + \frac{\Delta I_{L2}}{2}$$

Calculate the minimum inductance values L_{1MIN} and L_{2MIN} in henries with the inductor current ripples set to the maximum value as follows:

$$L_{1MIN} = \frac{(V_{IN_MIN} - V_{DS} - 0.3V) \times D_{MAX}}{f_{SW} \times \Delta I_{L1}}$$

$$L_{2MIN} = \frac{(V_{IN_MIN} - V_{DS} - 0.3V) \times D_{MAX}}{f_{SW} \times \Delta I_{L2}}$$

where 0.3V is the peak current-sense voltage. Choose inductors that have a minimum inductance greater than the calculated L_{1MIN} and L_{2MIN} and current rating greater than I_{L1P} and I_{L2P} , respectively. The recommended saturation current limit of the selected inductor is 10% higher than the inductor peak current:

For simplifying further calculations, consider L1 and L2 as a single inductor with L1 and L2 connected in parallel.

The combined inductance value and current is calculated as follows:

$$L_{MIN} = \frac{L_{1MIN} \times L_{2MIN}}{L_{1MIN} + L_{2MIN}}$$

and:

$$I_{L_AVG} = I_{L1AVG} + I_{L2AVG}$$

where I_{L_AVG} represents the total average current through both the inductors together for SEPIC configuration. Use these values in the calculations for SEPIC configuration in the following sections.

Select coupling capacitor C_S so that the peak-to-peak ripple on it is less than 2% of the minimum input supply voltage. This ensures that the second-order effects created by the series resonant circuit comprising L1, C_S , and L2 does not affect the normal operation of the converter. Use the following equation to calculate the minimum value of C_S :

$$C_S \geq \frac{I_{LED} \times D_{MAX}}{V_{IN_MIN} \times 0.02 \times f_{SW}}$$

where C_S is the minimum value of the coupling capacitor in farads, I_{LED} is the LED current in amperes, and the factor 0.02 accounts for 2% ripple.

Slope Compensation

The MAX16814 generates a current ramp for slope compensation. This ramp current is in sync with the switching frequency and starts from zero at the beginning of every clock cycle and rises linearly to reach $50\mu A$ at the end of the clock cycle. The slope-compensating resistor, R_{SCOMP} , is connected between the CS input and the source of the external MOSFET. This adds a programmable ramp voltage to the CS input voltage to provide slope compensation.

Use the following equation to calculate the value of slope compensation resistance (R_{SCOMP}).

For boost configuration:

$$R_{SCOMP} = \frac{(V_{LED} - 2V_{IN_MIN}) \times R_{CS} \times 3}{L_{MIN} \times 50\mu A \times f_{SW} \times 4}$$

For SEPIC and coupled-inductor boost-buck:

$$R_{\text{SCOMP}} = \frac{(V_{\text{LED}} - V_{\text{IN_MIN}}) \times R_{\text{CS}} \times 3}{L_{\text{MIN}} \times 50\mu\text{A} \times f_{\text{SW}} \times 4}$$

where V_{LED} and $V_{\text{IN_MIN}}$ are in volts, R_{SCOMP} and R_{CS} are in ohms, L_{MIN} is in henries and f_{SW} is in hertz.

The value of the switch current-sense resistor, R_{CS} , can be calculated as follows:

For boost:

$$0.396 \times 0.9 = I_{\text{LP}} \times R_{\text{CS}} + \frac{(D_{\text{MAX}} \times (V_{\text{LED}} - 2V_{\text{IN_MIN}}) \times R_{\text{CS}} \times 3)}{4 \times L_{\text{MN}} \times f_{\text{SW}}}$$

For SEPIC and boost-buck:

$$0.396 \times 0.9 = I_{\text{LP}} \times R_{\text{CS}} + \frac{(D_{\text{MAX}} \times (V_{\text{LED}} - V_{\text{IN_MIN}}) \times R_{\text{CS}} \times 3)}{4 \times L_{\text{MN}} \times f_{\text{SW}}}$$

where 0.396 is the minimum value of the peak current-sense threshold. The current-sense threshold also includes the slope compensation component. The minimum current-sense threshold of 0.396 is multiplied by 0.9 to take tolerances into account.

Output Capacitor Selection

For all the three converter topologies, the output capacitor supplies the load current when the main switch is on. The function of the output capacitor is to reduce the converter output ripple to acceptable levels. The entire output-voltage ripple appears across constant current-sink outputs because the LED string voltages are stable due to the constant current. For the MAX16814, limit the peak-to-peak output voltage ripple to 200mV to get stable output current.

The ESR, ESL, and the bulk capacitance of the output capacitor contribute to the output ripple. In most of the applications, using low-ESR ceramic capacitors can dramatically reduce the output ESR and ESL effects. To reduce the ESL and ESR effects, connect multiple ceramic capacitors in parallel to achieve the required bulk capacitance. To minimize audible noise during PWM dimming, the amount of ceramic capacitors on the output are usually minimized. In this case, an additional electrolytic or tantalum capacitor provides most of the bulk capacitance.

External MOSFET Selection

The external MOSFET should have a voltage rating sufficient to withstand the maximum output voltage together with the rectifier diode drop and any possible overshoot due to ringing caused by parasitic inductances and capacitances. The recommended MOSFET V_{DS} voltage rating is 30% higher than the sum of the maximum output voltage and the rectifier diode drop.

The recommended continuous drain current rating of the MOSFET (I_{D}), when the case temperature is at +70°C, is greater than that calculated below:

$$I_{\text{DRMS}} = \left(\sqrt{I_{\text{L_AVG}}^2 \times D_{\text{MAX}}} \right) \times 1.3$$

The MOSFET dissipates power due to both switching losses and conduction losses. Use the following equation to calculate the conduction losses in the MOSFET:

$$P_{\text{COND}} = I_{\text{L_AVG}}^2 \times D_{\text{MAX}} \times R_{\text{DS(ON)}}$$

where $R_{\text{DS(ON)}}$ is the on-state drain-to-source resistance of the MOSFET.

Use the following equation to calculate the switching losses in the MOSFET:

$$P_{\text{SW}} = \frac{I_{\text{L_AVG}} \times V_{\text{LED}}^2 \times C_{\text{GD}} \times f_{\text{SW}}}{2} \times \left(\frac{1}{I_{\text{GON}}} + \frac{1}{I_{\text{GOFF}}} \right)$$

where I_{GON} and I_{GOFF} are the gate currents of the MOSFET in amperes, when it is turned on and turned off, respectively. C_{GD} is the gate-to-drain MOSFET capacitance in farads.

Rectifier Diode Selection

Using a Schottky rectifier diode produces less forward drop and puts the least burden on the MOSFET during reverse recovery. A diode with considerable reverse-recovery time increases the MOSFET switching loss. Select a Schottky diode with a voltage rating 20% higher than the maximum boost-converter output voltage and current rating greater than that calculated in the following equation:

$$I_{\text{D}} = I_{\text{L_AVG}} \times (1 - D_{\text{MAX}}) \times 1.2$$

Feedback Compensation

During normal operation, the feedback control loop regulates the minimum OUT_ voltage to 1V when LED string currents are enabled during PWM dimming. When LED currents are off during PWM dimming, the control loop turns off the converter and stores the steady-state condition in the form of capacitor voltages, mainly the output filter capacitor voltage and compensation capacitor voltage. For the MAX16814A_ and the MAX16814U_ , when the PWM dimming pulses are less than or equal to 5 switching clock cycles, the feedback loop regulates the converter output voltage to 95% of OVP threshold.

The worst-case condition for the feedback loop is when the LED driver is in normal mode regulating the minimum OUT_ voltage to 1V. The switching converter small-signal transfer function has a right-half plane (RHP) zero for boost configuration if the inductor current is in continuous conduction mode. The RHP zero adds a 20dB/decade gain together with a 90°-phase lag, which is difficult to compensate.

The worst-case RHP zero frequency (f_{ZRHP}) is calculated as follows:

For boost configuration:

$$f_{ZRHP} = \frac{V_{LED}(1-D_{MAX})^2}{2\pi \times L \times I_{LED}}$$

For SEPIC and coupled-inductor boost-buck configurations:

$$f_{ZRHP} = \frac{V_{LED}(1-D_{MAX})^2}{2\pi \times L \times I_{LED} \times D_{MAX}}$$

where f_{ZRHP} is in hertz, V_{LED} is in volts, L is the inductance value of L_1 in henries, and I_{LED} is in amperes. A simple way to avoid this zero is to roll off the loop gain to 0dB at a frequency less than one fifth of the RHP zero frequency with a -20dB/decade slope.

The switching converter small-signal transfer function also has an output pole. The effective output impedance together with the output filter capacitance determines the output pole frequency f_{P1} that is calculated as follows:

For boost configuration:

$$f_{P1} = \frac{I_{LED}}{2 \times \pi \times V_{LED} \times C_{OUT}}$$

For SEPIC and coupled-inductor boost-buck configurations:

$$f_{P1} = \frac{I_{LED} \times D_{MAX}}{2 \times \pi \times V_{LED} \times C_{OUT}}$$

where f_{P1} is in hertz, V_{LED} is in volts, I_{LED} is in amperes, and C_{OUT} is in farads.

Compensation components (R_{COMP} and C_{COMP}) perform two functions. C_{COMP} introduces a low-frequency pole that presents a -20dB/decade slope to the loop gain. R_{COMP} flattens the gain of the error amplifier for frequencies above the zero formed by R_{COMP} and C_{COMP} . For compensation, this zero is placed at the output pole frequency f_{P1} so that it provides a -20dB/decade slope for frequencies above f_{P1} to the combined modulator and compensator response.

The value of R_{COMP} needed to fix the total loop gain at f_{P1} so that the total loop gain crosses 0dB with -20dB/decade slope at 1/5 the RHP zero frequency is calculated as follows:

For boost configuration:

$$R_{COMP} = \frac{f_{ZRHP} \times R_{CS} \times I_{LED}}{5 \times f_{P1} \times GM_{COMP} \times V_{LED} \times (1-D_{MAX})}$$

For SEPIC and coupled-inductor boost-buck configurations:

$$R_{COMP} = \frac{f_{ZRHP} \times R_{CS} \times I_{LED} \times D_{MAX}}{5 \times f_{P1} \times GM_{COMP} \times V_{LED} \times (1-D_{MAX})}$$

where R_{COMP} is the compensation resistor in ohms, f_{ZRHP} and f_{P2} are in hertz, R_{CS} is the switch current-sense resistor in ohms, and GM_{COMP} is the transconductance of the error amplifier (600 μ S).

The value of C_{COMP} is calculated as follows:

$$C_{COMP} = \frac{1}{2\pi \times R_{COMP} \times f_{Z1}}$$

where f_{Z1} is the compensation zero placed at 1/5 of the crossover frequency that is, in turn, set at 1/5 of the f_{ZRHP} .

If the output capacitors do not have low ESR, the ESR zero frequency may fall within the 0dB crossover frequency. An additional pole may be required to cancel out this pole placed at the same frequency. This is usually implemented by connecting a capacitor in parallel with CCOMP and RCOMP. Figure 5 shows the SEPIC configuration and Figure 6 shows the coupled-inductor boost-buck configuration.

Analog Dimming Using External Control Voltage

Connect a resistor RSETI2 to the SETI input as shown in Figure 7 for controlling the LED string current using an external control voltage. The MAX16814 applies a fixed 1.23V bandgap reference voltage at SETI and measures the current through SETI. This measured current

multiplied by a factor of 1220 is the current through each one of the four constant current-sink channels. Adjust the current through SETI to get analog dimming functionality by connecting the external control voltage to SETI through the resistor RSETI2. The resulting change in the LED current with the control voltage is linear and inversely proportional. The LED current control range remains between 20mA to 150mA.

Use the following equation to calculate the LED current set by the control voltage applied:

$$I_{OUT} = \frac{1500}{R_{SETI}} + \frac{(1.23 - V_C)}{R_{SETI2}} \times 1220$$

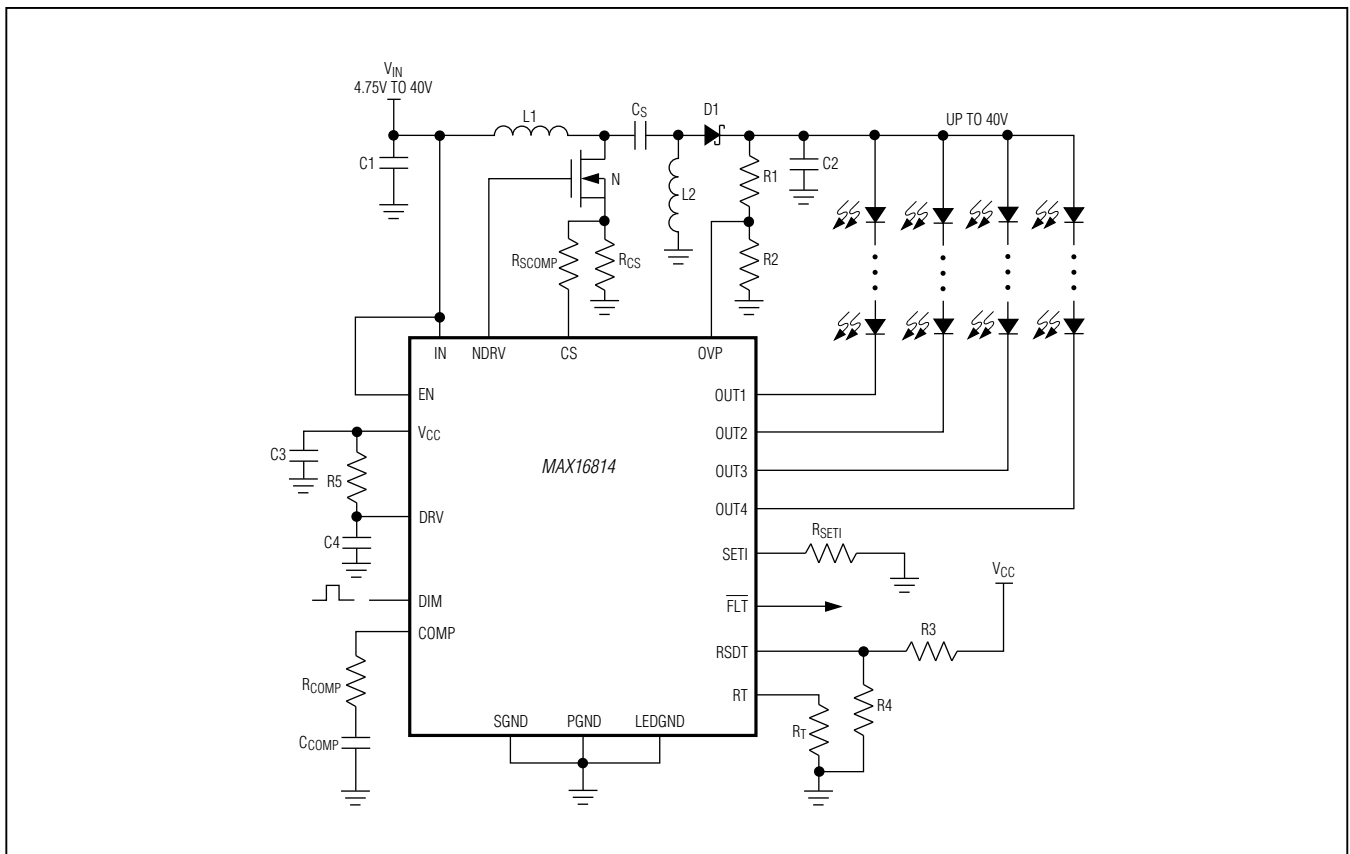

Figure 5. SEPIC Configuration

PCB Layout Considerations

LED driver circuits based on the MAX16814 device use a high-frequency switching converter to generate the voltage for LED strings. Take proper care while laying out the circuit to ensure proper operation. The switching-converter part of the circuit has nodes with very fast voltage changes that could lead to undesirable effects on the sensitive parts of the circuit. Follow the guidelines below to reduce noise as much as possible:

- 1) Connect the bypass capacitor on VCC and DRV as close to the device as possible and connect the capacitor ground to the analog ground plane using vias close to the capacitor terminal. Connect SGND of the device to the analog ground plane using a via close to SGND. Lay the analog ground plane on the inner layer, preferably next to the top layer. Use the analog ground plane to cover the entire area under critical signal components for the power converter.
- 2) Have a power ground plane for the switching-converter power circuit under the power components (input filter capacitor, output filter capacitor, inductor, MOSFET, rectifier diode, and current-sense resistor). Connect PGND to the power ground plane as close to PGND as possible. Connect all other ground connections to the power ground plane using vias close to the terminals.
- 3) There are two loops in the power circuit that carry high-frequency switching currents. One loop is when the MOSFET is on (from the input filter capacitor positive terminal, through the inductor, the internal MOSFET, and the current-sense resistor, to the input capacitor negative terminal). The other loop is when the MOSFET is off (from the input capacitor positive terminal, through the inductor, the rectifier diode, output filter capacitor, to the input capacitor negative terminal). Analyze these two loops and make the loop areas as small as possible. Wherever possible, have a return path on the power ground plane for the switching currents on the top layer copper traces, or through power components. This reduces the loop area considerably and provides a low-inductance path for the switching currents. Reducing the loop area also reduces radiation during switching.
- 4) Connect the power ground plane for the constant-current LED driver part of the circuit to LEDGND as close to the device as possible. Connect SGND to PGND at the same point.

MAX16814

Integrated, 4-Channel, High-Brightness LED Driver with High-Voltage DC-DC Controller

Ordering Information

PART	TEMP RANGE	PIN-PACKAGE
MAX16814ATP+	-40°C to +125°C	20 TQFN-EP*
MAX16814ATP/V+	-40°C to +125°C	20 TQFN-EP*
MAX16814AGP/VY+	-40°C to +125°C	20 QFND-EP* (SW)
MAX16814AUP+	-40°C to +125°C	20 TSSOP-EP*
MAX16814AUP/V+	-40°C to +125°C	20 TSSOP-EP*
MAX16814BETP+	-40°C to +85°C	20 TQFN-EP*
MAX16814BEUP+	-40°C to +85°C	20 TSSOP-EP*
MAX16814BUTP+	0°C to +85°C	20 TQFN-EP*
MAX16814BUUP+	0°C to +85°C	20 TSSOP-EP*
MAX16814UTP+	0°C to +85°C	20 TQFN-EP*
MAX16814UUP+	0°C to +85°C	20 TSSOP-EP*

+Denotes a lead(Pb)-free/RoHS-compliant package.

*EP = Exposed pad.

V denotes an automotive qualified part; (SW) = side wettable.

Chip Information

PROCESS: BiCMOS DMOS

Package Information

For the latest package outline information and land patterns, go to www.maximintegrated.com/packages. Note that a "+", "#", or "-" in the package code indicates RoHS status only. Package drawings may show a different suffix character, but the drawing pertains to the package regardless of RoHS status.

PACKAGE TYPE	PACKAGE CODE	OUTLINE NO.	LAND PATTERN NO.
20 TSSOP-EP	U20E+1	21-0108	90-0114
20 TQFN-EP	T2044+3	21-0139	90-0037
20 QFND-EP (Side Wettable)	G2044Y+1	21-0576	90-0360

Revision History

REVISION NUMBER	REVISION DATE	DESCRIPTION	PAGES CHANGED
0	7/09	Initial release	—
1	9/09	Correction to slope compensation description and block diagram	10, 18
2	11/09	Correction to synchronization description frequency and minor edits	1–4, 8, 12–20, 22, 25
3	2/10	Correction to CSYNC formula	13
4	6/10	Added MAX16814BE __ parts; corrected specification	1–4, 8, 13, 25
5	3/11	Correction to output current accuracy specification and <i>Absolute Maximum Ratings</i>	1, 2, 4
6	10/11	Correction to the last formula and description	19
7	1/13	Added side-wettable package option and updated EN leakage in <i>Electrical Characteristics</i>	1, 2, 4, 8, 9, 23, 24
8	4/13	Minor corrections to Figures 1, 2, and the <i>LED Dimming Control</i> , <i>Rectifier Diode Selection</i> , and <i>Feedback Compensation</i> sections	10, 11, 14, 18, 19
9	11/13	Corrected V_{COMP} offset voltage in Figure 1	10
10	2/15	Updated the <i>Benefits and Features</i> section	1
11	3/16	Updated the <i>LED Dimming Control</i> section	14

For pricing, delivery, and ordering information, please contact Maxim Direct at 1-888-629-4642, or visit Maxim Integrated's website at www.maximintegrated.com.

Maxim Integrated cannot assume responsibility for use of any circuitry other than circuitry entirely embodied in a Maxim Integrated product. No circuit patent licenses are implied. Maxim Integrated reserves the right to change the circuitry and specifications without notice at any time. The parametric values (min and max limits) shown in the *Electrical Characteristics* table are guaranteed. Other parametric values quoted in this data sheet are provided for guidance.