

36V, 2A Synchronous  
Step-Down LED Driver

FEATURES

- $\pm 1.5\%$  LED Current Regulation
- $\pm 1.2\%$  Output Voltage Regulation
- 5000:1/10000+:1 PWM Dimming at 100Hz (LT3932/LT3932-1)
- 128:1 Internal PWM Dimming
- Spread-Spectrum Frequency Modulation
- Silent Switcher® Architecture for Low EMI
- 3.6V to 36V Input Voltage Range
- 0V to 36V LED String Voltage
- 200kHz to 2MHz with SYNC Function
- 99.9% Maximum Duty Cycle
- 20:1 Analog or Duty Cycle LED Current Control
- Open/Short LED Protection and Fault Indication
- Accurate LED Current Sense with Monitor Output
- Programmable UVLO
- Thermally Enhanced 28-Pin (4mm x 5mm) QFN

APPLICATIONS

- Automotive Lighting
- Industrial and General Purpose Lighting
- Machine Vision Systems

DESCRIPTION

The LT®3932 , featuring the Silent Switcher® architecture to minimize EMI/EMC emissions, utilizes fixed-frequency, peak current control and provides PWM dimming for a string of LEDs. The LED current is programmed by an analog voltage or the duty cycle of pulses at the CTRL pin. An output voltage limit can be set with a resistor divider to the FB pin.

The switching frequency is programmable from 200kHz to 2MHz by an external resistor at the RT pin or by an external clock at the SYNC/SPRD pin. With the optional spread spectrum frequency modulation enabled, the frequency varies from 100% to 125% to reduce EMI. The LT3932 also includes a driver for an external, high side PMOS for PWM dimming and an internal PWM signal generator for analog control of PWM dimming when an external signal is not available. The LT3932-1 permits higher dimming ratios.

Additional features include an LED current monitor, an accurate EN/UVLO pin threshold, open-drain fault reporting for open-circuit and short-circuit load conditions, and thermal shutdown.

All registered trademarks and trademarks are the property of their respective owners. Protected by U.S. Patents including 7199560, 7321203, 9596728, 9642200 and other patents pending.

TYPICAL APPLICATION

2A LED Driver with Internal PWM Dimming

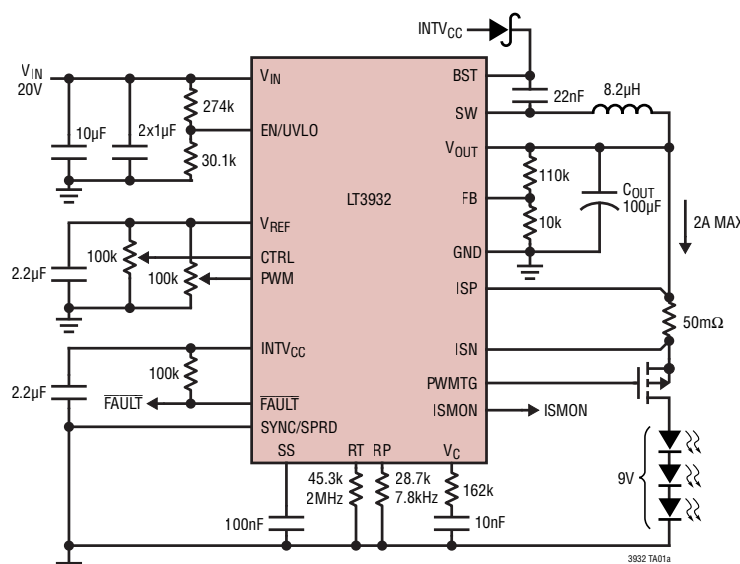

Internal PWM Dimming

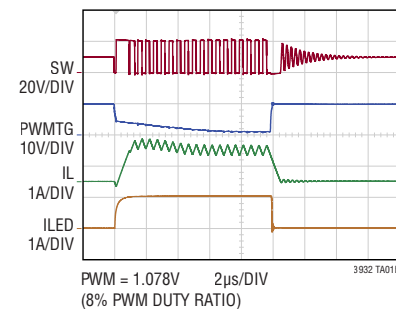

# LT3932/LT3932-1

## ABSOLUTE MAXIMUM RATINGS

(Note 1)

$V_{IN}$ , EN/UVLO.....	40V
ISP, ISN, and $V_{OUT}$ .....	40V
ISP – ISN .....	±0.3V
CTRL and FB .....	3.3V
PWM, SYNC/SPRD, and $\overline{FAULT}$ .....	6V
SS and $V_C$ .....	3.3V
SW, BST, INTV <sub>CC</sub> , $V_{REF}$ , ISMON, PWMTG, RT, and RP .....	(Note 2)
Operating Junction Temperature Range (Notes 3, 4)	
LT3932E/LT3932I .....	–40°C to 125°C
LT3932H .....	–40°C to 150°C
Storage Temperature Range .....	–65°C to 150°C

## PIN CONFIGURATION

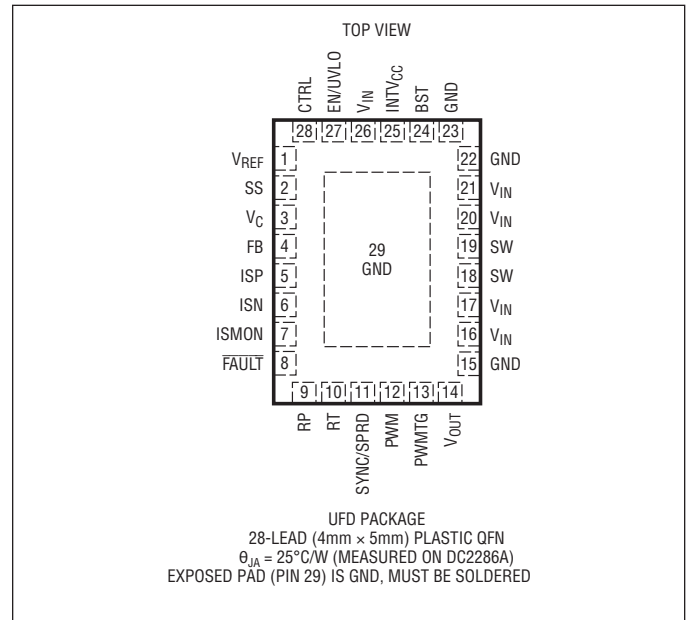

## ORDER INFORMATION

LEAD FREE FINISH	TAPE AND REEL	PART MARKING*	PACKAGE DESCRIPTION	TEMPERATURE RANGE
LT3932EUFD#PBF	LT3932EUFD#TRPBF	3932	28-Lead (4mm × 5mm) Plastic QFN	–40°C to 125°C
LT3932IUFD#PBF	LT3932IUFD#TRPBF	3932	28-Lead (4mm × 5mm) Plastic QFN	–40°C to 125°C
LT3932HUFD#PBF	LT3932HUFD#TRPBF	3932	28-Lead (4mm × 5mm) Plastic QFN	–40°C to 150°C
LT3932EUFD-1#PBF	LT3932EUFD-1#TRPBF	39321	28-Lead (4mm × 5mm) Plastic QFN	–40°C to 125°C
LT3932IUFD-1#PBF	LT3932IUFD-1#TRPBF	39321	28-Lead (4mm × 5mm) Plastic QFN	–40°C to 125°C
LT3932HUFD-1#PBF	LT3932HUFD-1#TRPBF	39321	28-Lead (4mm × 5mm) Plastic QFN	–40°C to 150°C

Contact the factory for parts specified with wider operating temperature ranges. \*The temperature grade is identified by a label on the shipping container.

[Tape and reel specifications](#). Some packages are available in 500 unit reels through designated sales channels with #TRMPBF suffix.

## ELECTRICAL CHARACTERISTICS

The ● denotes the specifications which apply over the full operating temperature range, otherwise specifications are at  $T_A = 25^{\circ}\text{C}$ .  $V_{IN} = 12\text{V}$ ,  $V_{EN/UVLO} = 5\text{V}$  unless otherwise noted.

PARAMETER	CONDITIONS	MIN	TYP	MAX	UNITS
Input Voltage Range		3.6		36	V
$V_{IN}$ Pin Quiescent Current	EN/UVLO = 2V, Not Switching EN/UVLO = 300mV, Shutdown		2.2	2.7	mA
EN/UVLO Threshold (Falling)		1.09	1.15	1.21	V
EN/UVLO Rising Hysteresis			20		mV
EN/UVLO Pin Hysteresis Current			4		μA

Rev B

**ELECTRICAL CHARACTERISTICS** The ● denotes the specifications which apply over the full operating temperature range, otherwise specifications are at  $T_A = 25^\circ\text{C}$ .  $V_{IN} = 12\text{V}$ ,  $V_{EN/UVLO} = 5\text{V}$  unless otherwise noted.

PARAMETER	CONDITIONS		MIN	TYP	MAX	UNITS
<b>Reference</b>						
$V_{REF}$ Voltage	$I_{VREF} = 0\mu\text{A}$ $I_{VREF} = 500\mu\text{A}$	●	1.975 1.980	2 1.998	2.020 2.016	V V
$V_{REF}$ Pin Current Limit	$V_{REF} = 1.9\text{V}$ , Current Out of Pin			2		mA
<b>LED Current Regulation</b>						
CTRL-Off Threshold (Falling)		●	200	218	228	mV
CTRL-Off Rising Hysteresis				20		mV
CTRL Pin Current	$V_{CTRL} = 2\text{V}$		-100		100	nA
Sense Voltage ( $V_{ISP}-V_{ISN}$ ) (Analog Input)	$V_{CTRL} = 1.5\text{V}$ (100%), $V_{IN} = 36\text{V}$ , $V_{ISP} = 24\text{V}$ $V_{CTRL} = 750\text{mV}$ (50%), $V_{IN} = 36\text{V}$ , $V_{ISP} = 24\text{V}$ $V_{CTRL} = 300\text{mV}$ (5%), $V_{IN} = 36\text{V}$ , $V_{ISP} = 24\text{V}$	● ● ●	98.5 48.5 4	100 50 5	101.5 51.5 6	mV mV mV
ISP Pin Current	$V_{IN} = 36\text{V}$ , $V_{ISP} = 24\text{V}$ , $V_{CTRL} = 2\text{V}$ , Current Into Pin			50		$\mu\text{A}$
ISN Pin Current	$V_{IN} = 36\text{V}$ , $V_{ISN} = 23.9\text{V}$ , $V_{CTRL} = 2\text{V}$ , Current Into Pin			50		$\mu\text{A}$
ISP/ISN Common Mode Range	$V_{IN} = 36\text{V}$ (Note 5)		0		36	V
Current Error Amplifier Transconductance	$V_{IN} = 36\text{V}$ , $V_{ISP} = 24\text{V}$			200		$\mu\text{A/V}$
<b>Duty Cycle Control of LED Current</b>						
Sense Voltage ( $V_{ISP}-V_{ISN}$ ) (Duty Cycle Input)	CTRL Duty = 75% (100%), $V_{IN} = 36\text{V}$ , $V_{ISP} = 24\text{V}$ CTRL Duty = 37.5% (50%), $V_{IN} = 36\text{V}$ , $V_{ISP} = 24\text{V}$ CTRL Duty = 15% (5%), $V_{IN} = 36\text{V}$ , $V_{ISP} = 24\text{V}$		99 49 4	100 50 5	101 51 6	mV mV mV
CTRL Pulse Input High ( $V_{IH}$ )			1.6			V
CTRL Pulse Input Low ( $V_{IL}$ )					0.4	V
CTRL Pulse Input Frequency Range			100		1000	kHz
<b>Voltage Regulation</b>						
FB Regulation Voltage	$V_{ISP} = V_{ISN} = 6\text{V}$ , $V_{CTRL} = 2\text{V}$	●	0.988	1.000	1.012	V
FB Pin Current	$V_{FB} = 1\text{V}$		-100		100	nA
Voltage Error Amplifier Transconductance				480		$\mu\text{A/V}$
<b>Power Stage</b>						
Peak Current Limit			3.0	3.6	4.2	A
Minimum Off-Time	(Note 6)			55		ns
Minimum On-Time	(Note 6)			55		ns
Bottom Switch On-Resistance				90		m $\Omega$
Top Switch On-Resistance				90		m $\Omega$
<b>Oscillator</b>						
Programmed Switching Frequency ( $f_{sw}$ )	$R_T = 45.3\text{k}$ , $V_{SYNC/SPRD} = 0\text{V}$ $R_T = 523\text{k}$ , $V_{SYNC/SPRD} = 0\text{V}$	● ●	1900 180	2000 200	2100 230	kHz kHz
Spread Spectrum Frequency Range	$R_T = 45.3\text{k}$ , $V_{SYNC/SPRD} = 3.3\text{V}$ $R_T = 523\text{k}$ , $V_{SYNC/SPRD} = 3.3\text{V}$		1900 180		2650 290	kHz kHz
RT Pin Current Limit	$V_{RT} = 0\text{V}$ , Current Out of Pin			34		$\mu\text{A}$
SYNC/SPRD Threshold (Rising)				1.4	1.5	V
SYNC/SPRD Falling Hysteresis				220		mV
SYNC/SPRD Pin Current	$V_{SYNC/SPRD} = 3.3\text{V}$		-100		100	nA
<b>Soft-Start</b>						
SS Pin Charging Current	$V_{SS} = 0\text{V}$			20		$\mu\text{A}$

# LT3932/LT3932-1

## ELECTRICAL CHARACTERISTICS

The ● denotes the specifications which apply over the full operating temperature range, otherwise specifications are at  $T_A = 25^\circ\text{C}$ .  $V_{IN} = 12\text{V}$ ,  $V_{EN/UVLO} = 5\text{V}$  unless otherwise noted.

PARAMETER	CONDITIONS		MIN	TYP	MAX	UNITS
SS Pin Discharging Current	$V_{SS} = 2\text{V}$			1.25		$\mu\text{A}$
SS Lower Threshold (Falling)				200		mV
SS Higher Threshold (Rising)				1.7		V
<b>Fault Detection</b>						
Open-Circuit Threshold (FB Rising)		●	930	950	970	mV
Open-Circuit Falling Hysteresis				55		mV
Short-Circuit Threshold (FB Falling)		●	180	200	220	mV
Short-Circuit Rising Hysteresis				50		mV
FAULT Pull-Down Current	$V_{\text{FAULT}} = 200\text{mV}$ , $V_{\text{FB}} = 0\text{V}$		100			$\mu\text{A}$
FAULT Leakage Current	$V_{\text{FAULT}} = 3.3\text{V}$ , $V_{\text{FB}} = 700\text{mV}$		-100		100	nA
<b>Overvoltage Protection</b>						
FB Overvoltage Threshold (FB Rising)				1.050		V
FB Overvoltage Falling Hysteresis				48		mV
<b>LED Current Monitor</b>						
ISMON Voltage	$V_{\text{ISP}} - V_{\text{ISN}} = 100\text{mV}$ (100%), $V_{\text{ISP}} = 12\text{V}$ $V_{\text{ISP}} - V_{\text{ISN}} = 10\text{mV}$ (10%), $V_{\text{ISP}} = 12\text{V}$		0.965	1.000	1.030	V
			80	100	120	mV
<b>PWM Driver</b>						
PWMTG Gate Drive ( $V_{\text{OUT}} - V_{\text{PWMTG}}$ )	$V_{\text{OUT}} = 12\text{V}$ , $V_{\text{PWM}} = 2\text{V}$	●		10	11	V
PWM Threshold (Rising)	$V_{\text{OUT}} = 12\text{V}$ , $V_{\text{RP}} = 0\text{V}$			1.4		V
PWM Falling Hysteresis	$V_{\text{OUT}} = 12\text{V}$ , $V_{\text{RP}} = 0\text{V}$			200		mV
PWM Pin Current	$V_{\text{PWM}} = 2\text{V}$		-100		100	nA
PWM to PWMTG Propagation Delay	$C_{\text{PWMTG}} = 2.2\text{nF}$ (Connected from $V_{\text{OUT}}$ to PWMTG), $V_{\text{OUT}} = 12\text{V}$	Turn-On		100		ns
		Turn-Off		100		ns
<b>Analog Control for PWM Dimming</b>						
PWM Voltage for 100% Dimming	$R_P = 28.7\text{k}$ , $V_{\text{REF}} = 2\text{V}$		2.00			V
PWM Voltage for 0% Dimming	$R_P = 28.7\text{k}$ , $V_{\text{REF}} = 2\text{V}$				0.99	V
PWM Dimming Accuracy	$R_P = 28.7\text{k}$ , $V_{\text{REF}} = 2\text{V}$ , $V_{\text{PWM}} = 1.1\text{V}$ $R_P = 28.7\text{k}$ , $V_{\text{REF}} = 2\text{V}$ , $V_{\text{PWM}} = 1.9\text{V}$	●	7.8	10	12.4	%
		●	87	90	93	%
PWM Dimming Frequency	$R_P = 28.7\text{k}$ , $R_T = 45.3\text{k}$ , $V_{\text{SYNC/SPRD}} = 0\text{V}$ $R_P = 332\text{k}$ , $R_T = 45.3\text{k}$ , $V_{\text{SYNC/SPRD}} = 0\text{V}$		7.42	7.81	8.20	kHz
			116	122	128	Hz
RP Pin Current Limit	$V_{\text{RP}} = 0\text{V}$ , Current Out of Pin			60		$\mu\text{A}$

**Note 1:** Stresses beyond those listed under Absolute Maximum Ratings may cause permanent damage to the device. Exposure to any Absolute Maximum Rating condition for extended periods may affect device reliability and lifetime.

**Note 2:** Do not apply a positive or negative voltage source to these pins, otherwise permanent damage may occur.

**Note 3:** The LT3932E is guaranteed to meet performance specifications from  $0^\circ\text{C}$  to  $125^\circ\text{C}$  junction temperature. Specifications over the  $-40^\circ\text{C}$  to  $125^\circ\text{C}$  operating junction temperature range are assured by design, characterization and correlation with statistical process controls. The LT3932I is guaranteed to meet performance specifications over the  $-40^\circ\text{C}$  to  $125^\circ\text{C}$  operating junction temperature range. The LT3932H is guaranteed over the  $-40^\circ\text{C}$  to  $150^\circ\text{C}$  operating junction temperature range. Operating lifetime is derated for junction temperatures greater than  $125^\circ\text{C}$ .

**Note 4:** This IC includes overtemperature protection that is intended to protect the device during momentary overload conditions. The maximum rated junction temperature will be exceeded when this protection is active. Continuous operation above the specified absolute maximum operating junction temperature may impair device reliability or permanently damage the device.

**Note 5:** The current sense error amplifier is tested with  $V_{\text{ISP}} = 36\text{V}$ , and separately, with  $V_{\text{ISN}} = 0\text{V}$ .

**Note 6:** The MIN on and off times are guaranteed by design and are not tested.

**TYPICAL PERFORMANCE CHARACTERISTICS**  $V_{IN} = 12V$ , unless otherwise noted.

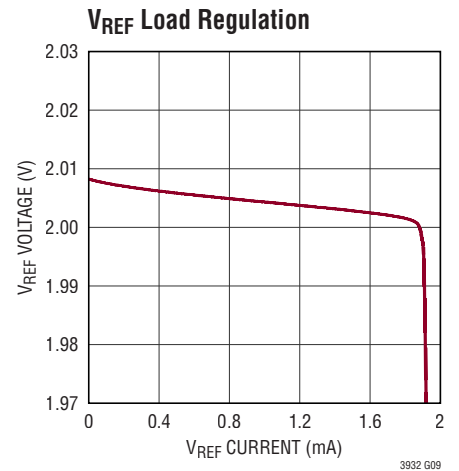
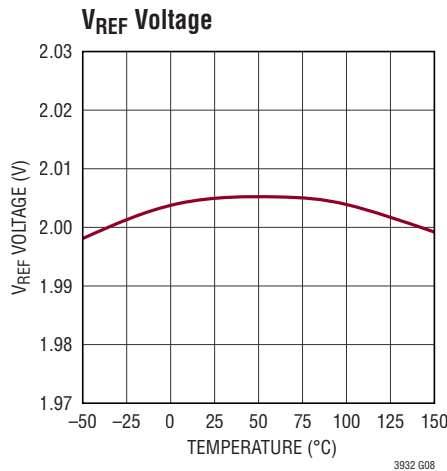
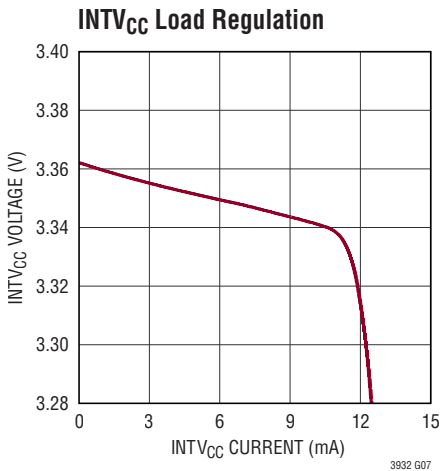
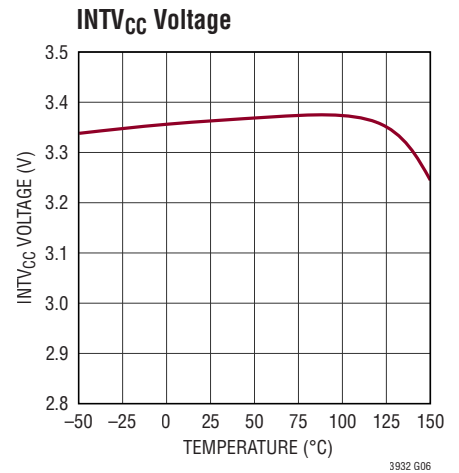
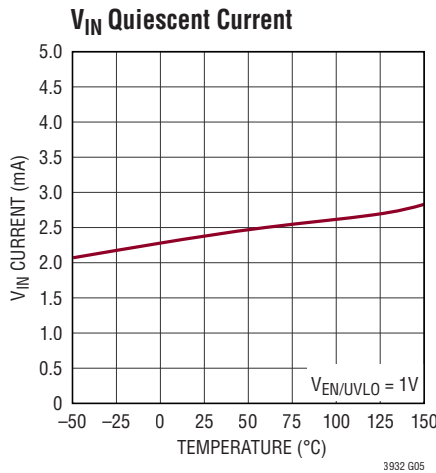
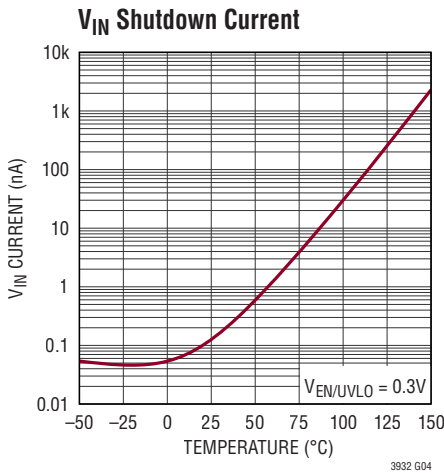
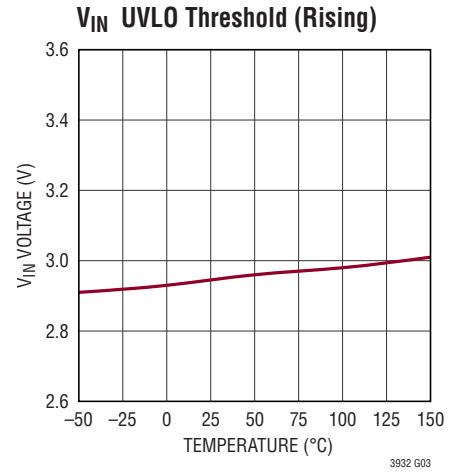
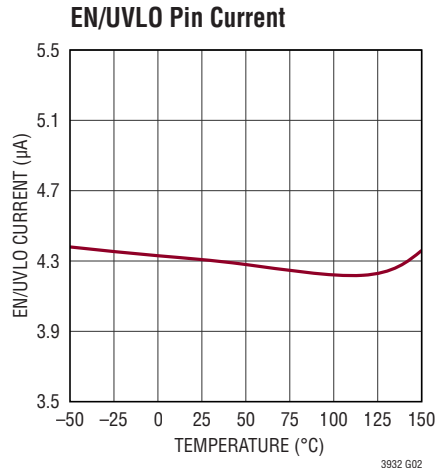
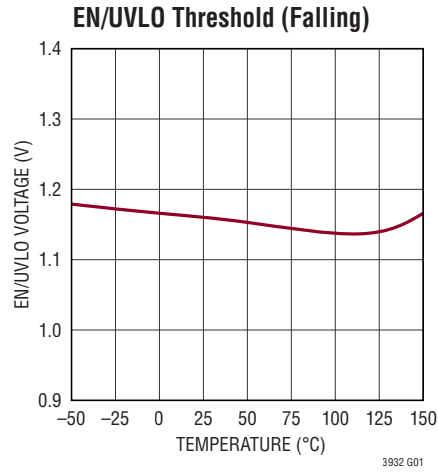

## TYPICAL PERFORMANCE CHARACTERISTICS $V_{IN} = 12V$ , unless otherwise noted.

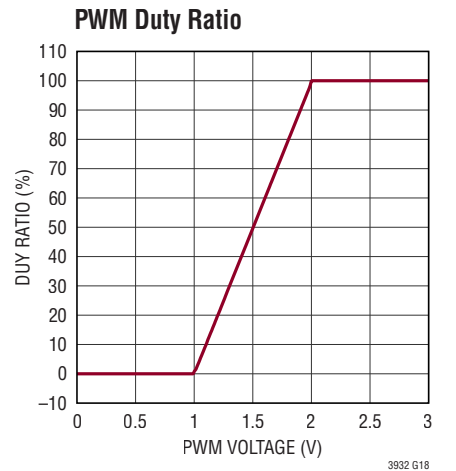
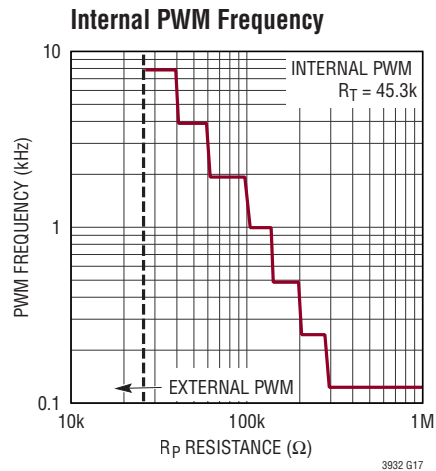
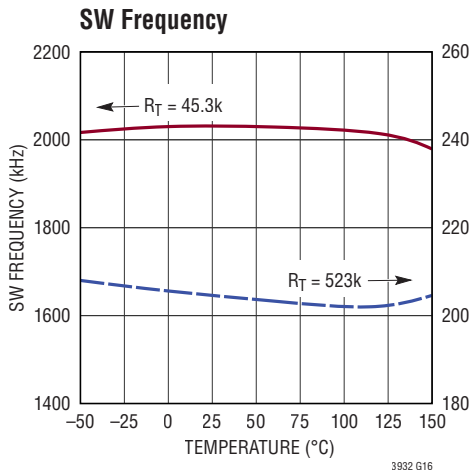
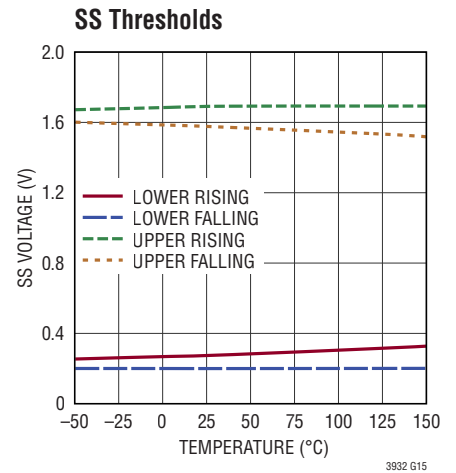
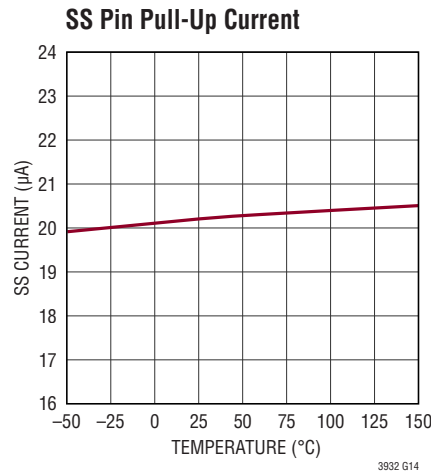
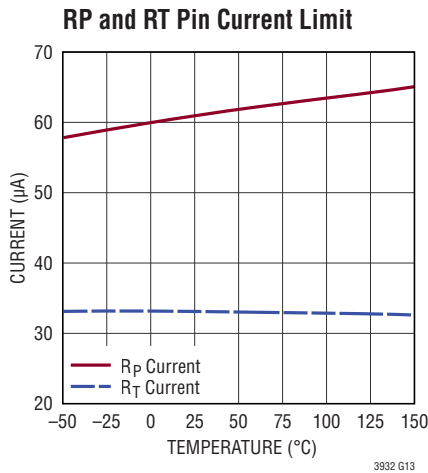
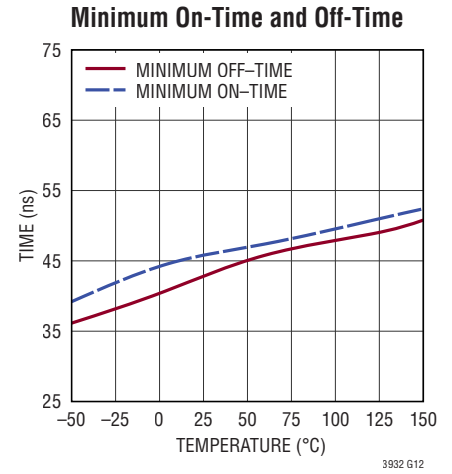
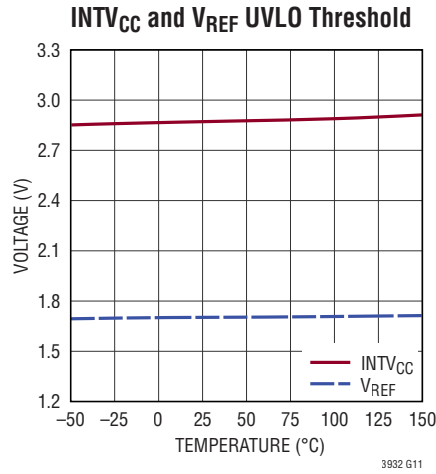
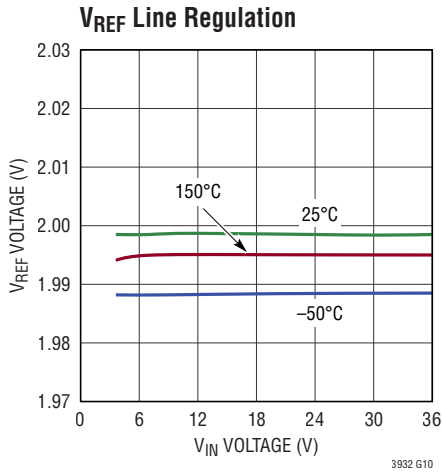

**TYPICAL PERFORMANCE CHARACTERISTICS**  $V_{IN} = 12V$ , unless otherwise noted.

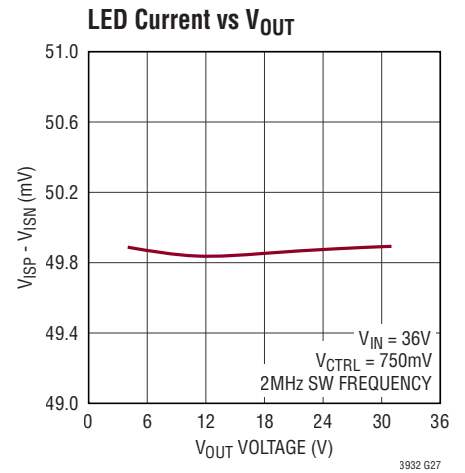
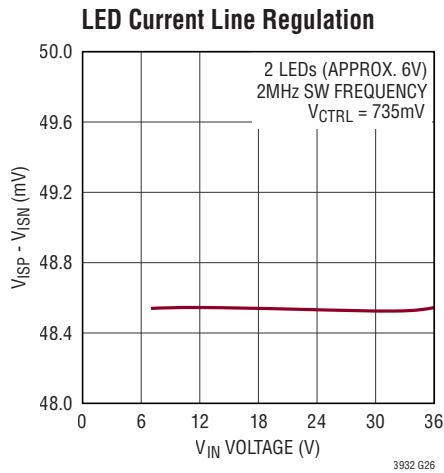
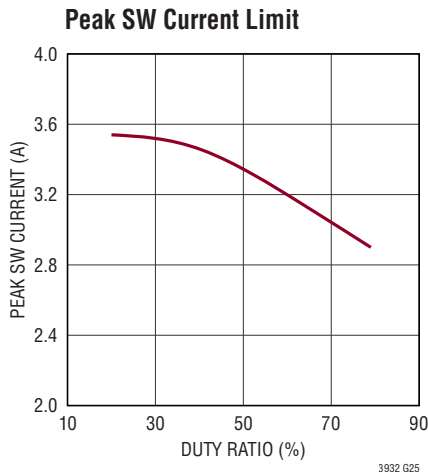
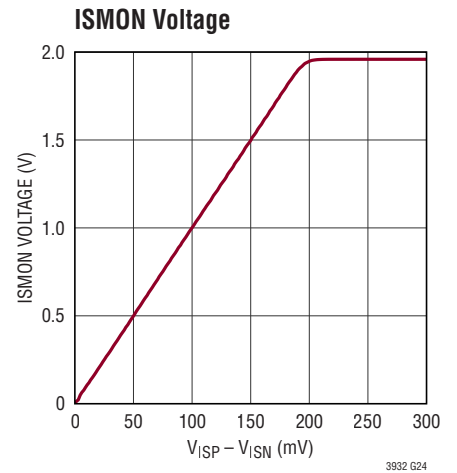
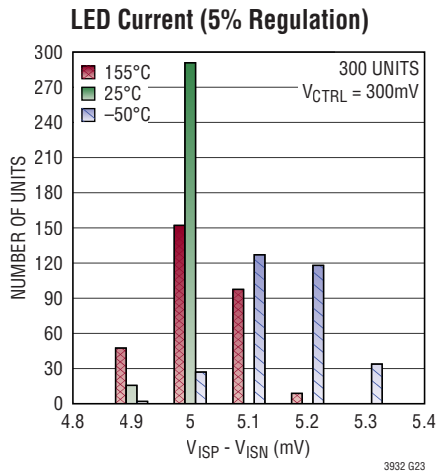
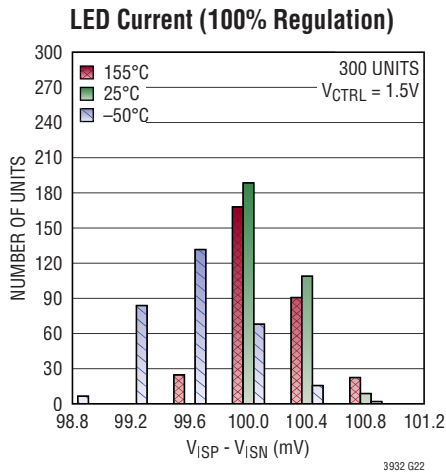
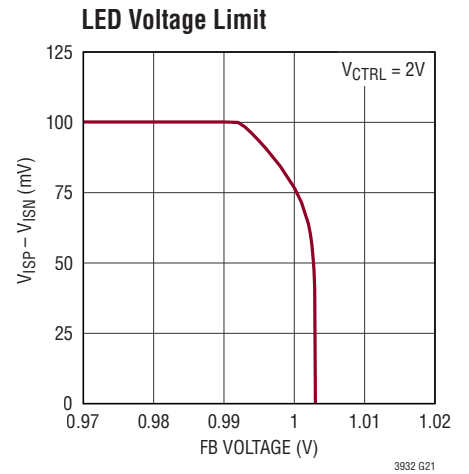
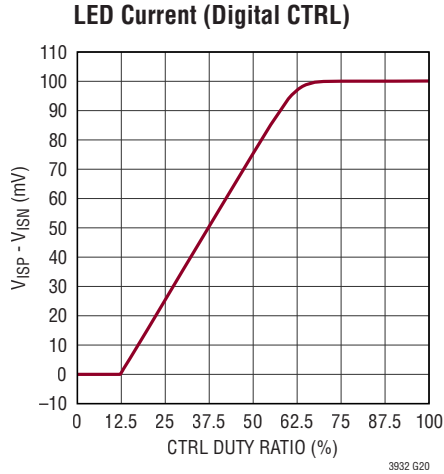
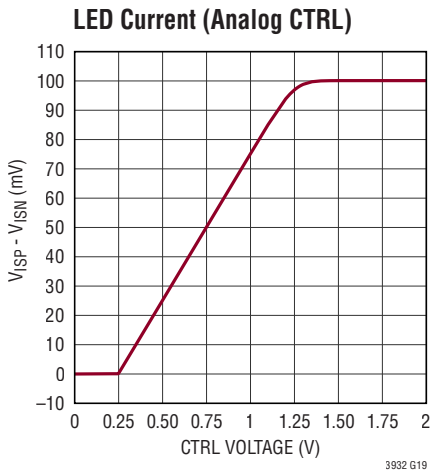

## TYPICAL PERFORMANCE CHARACTERISTICS $V_{IN} = 12V$ , unless otherwise noted.

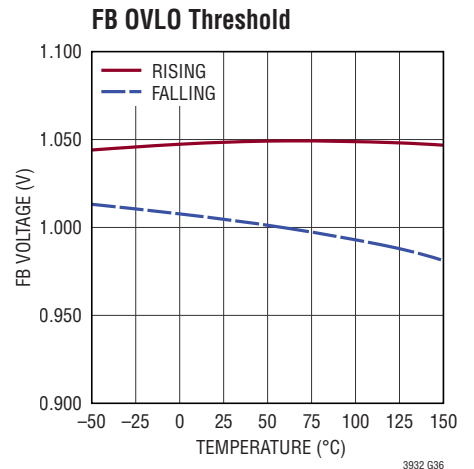
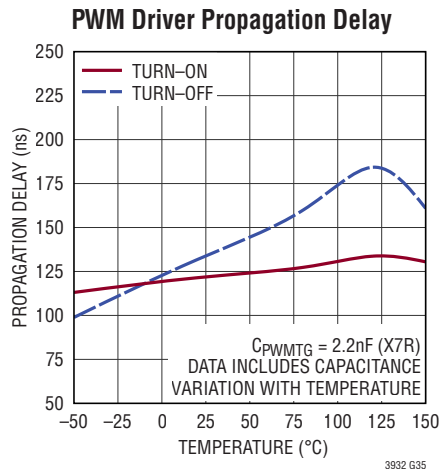
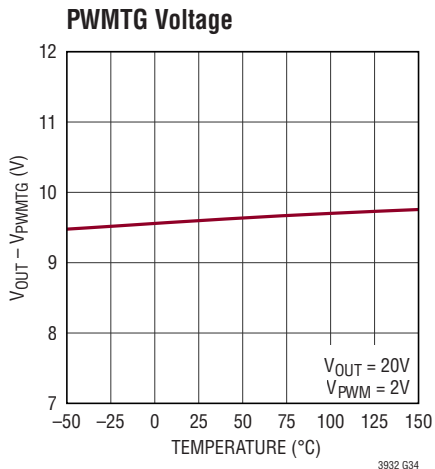
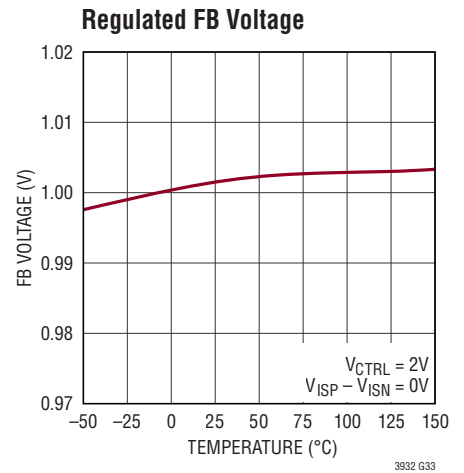
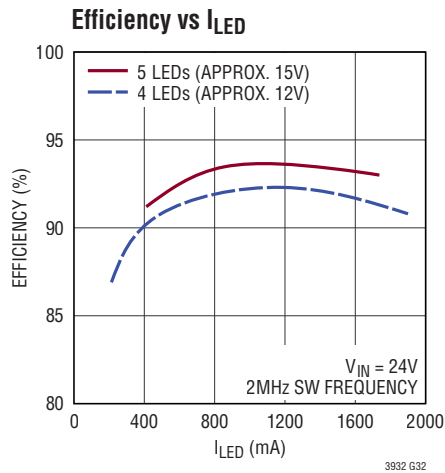
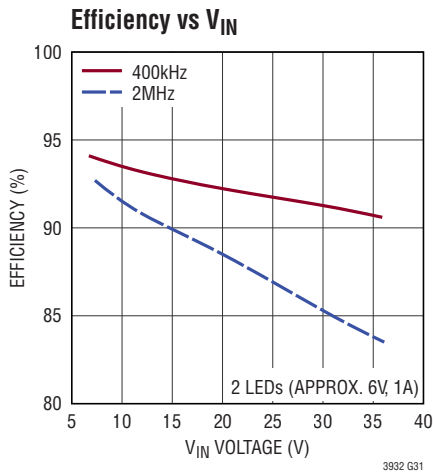
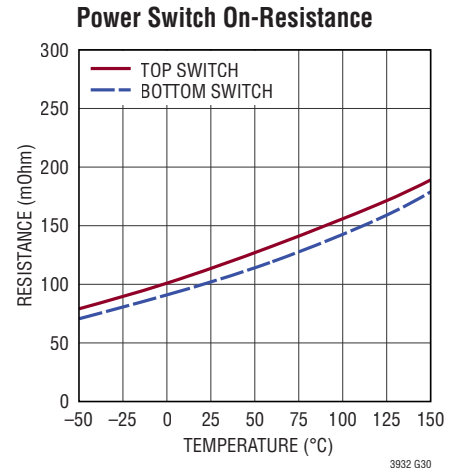
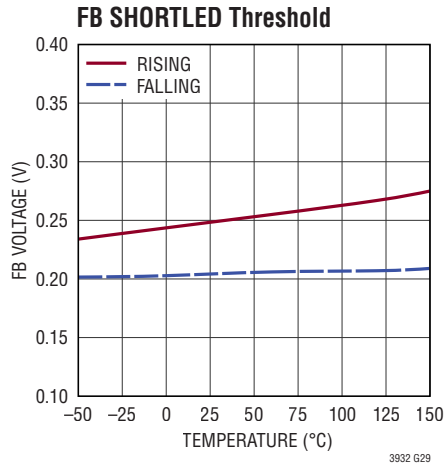
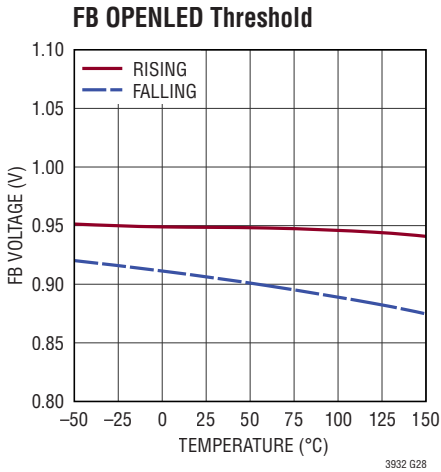



**TYPICAL PERFORMANCE CHARACTERISTICS**  $V_{IN} = 12V$ , unless otherwise noted.

**C/10 Threshold**

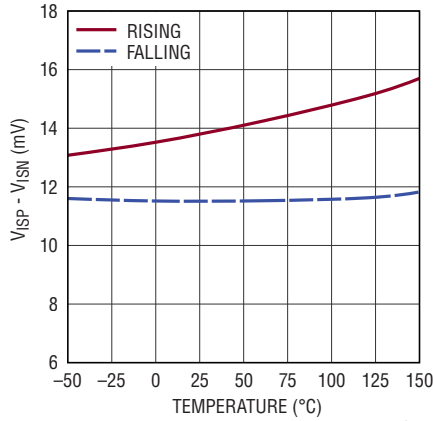

3932 G37

**DA Current Limit**

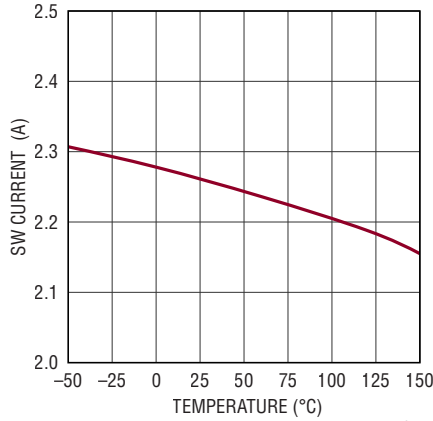

3932 G38

**Internal PWM Duty Ratio (10%)**

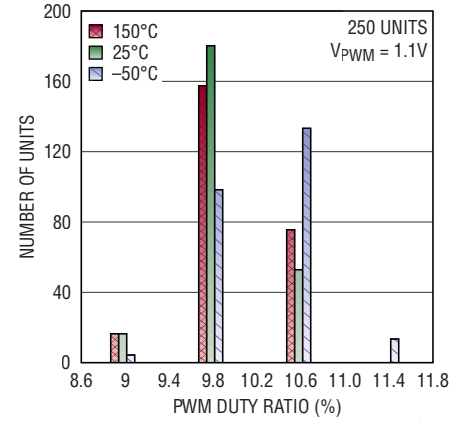

3932 G39

**Internal PWM Duty Ratio (90%)**

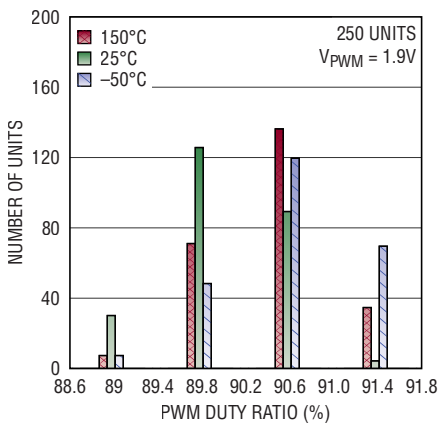

3932 G40

**Input Voltage Transient Response**

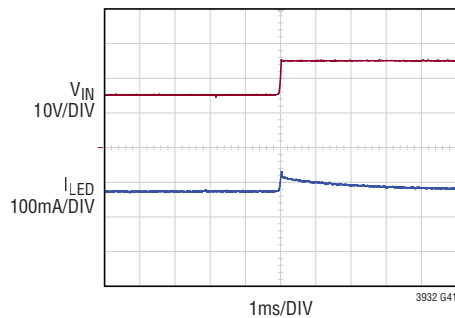

3932 G41

FRONT PAGE APPLICATION  
15V TO 25V INPUT VOLTAGE STEP  
3 LEDs (APPROX. 9V)

**Input Voltage Transient Response**

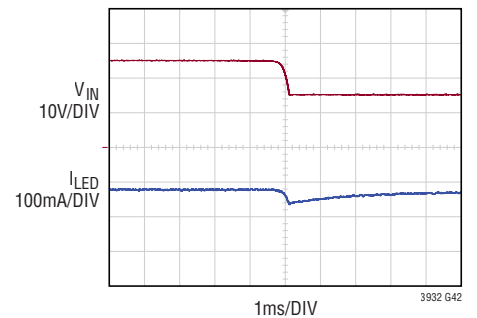

3932 G42

FRONT PAGE APPLICATION  
25V TO 15V INPUT VOLTAGE STEP  
3 LEDs (APPROX. 9V)

**Turn-On and Turn-Off**

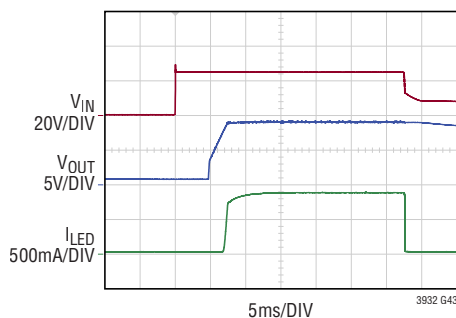

3932 G43

FRONT PAGE APPLICATION  
3 LEDs (APPROX. 9V)

**Start-Up with 10% Internal PWM**

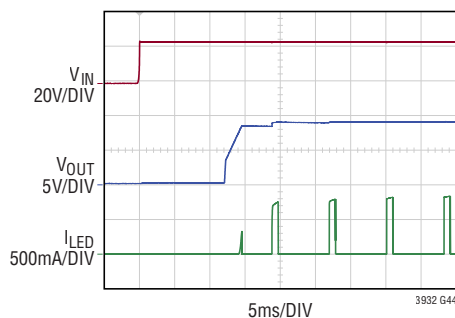

3932 G44

FRONT PAGE APPLICATION WITH PWM = 1.1V  
3 LEDs (APPROX. 9V)

**Start-Up with 90% Internal PWM**

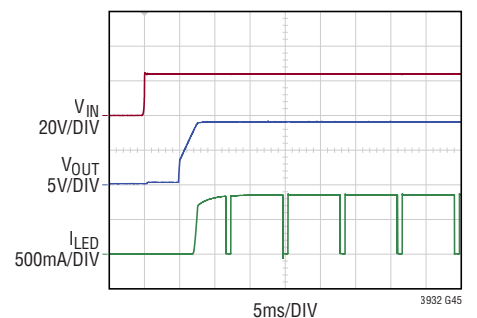

3932 G45

FRONT PAGE APPLICATION WITH PWM = 1.9V  
3 LEDs (APPROX. 9V)

## PIN FUNCTIONS

**V<sub>IN</sub>**: Input Voltage Pins. These pins supply power to the internal, high performance analog circuitry, and they supply the inductor current when the internal high side power switch is on. Connect capacitors between these pins and GND and see Selecting and Placing the Input Capacitors in Applications Information for advice regarding their placement.

**EN/UVLO**: Enable and Undervoltage Lockout Pin. A voltage at this pin greater than 1.15V will enable switching, and a voltage less than 300mV is guaranteed to shut down the internal current bias and sub-regulators. A resistor network between this pin and V<sub>IN</sub> can be used to set the pin voltage and automatically lockout the part when V<sub>IN</sub> is below a certain level. No internal components pull up or down on this pin, so it requires an external voltage bias for normal operation. This pin may be tied directly to V<sub>IN</sub>.

**INTV<sub>CC</sub>**: Internally Regulated, Low-Voltage Supply Pin. This pin provides the power for the converter switch gate drivers. Do not force any voltage on this pin, but bypass it with a 2.2μF capacitor to GND.

**ISP**: Positive Current Sense Pin. This pin is one of the inputs to the internal current sense error amplifier. It should be connected to the positive side of the external sense resistor.

**ISN**: Negative Current Sense Pin. This pin is one of the inputs to the internal current sense error amplifier. It should be connected to the negative side of the external sense resistor.

**ISMON**: Output Current Monitoring Pin. This pin provides a buffered voltage output equal to 10mV for every 1mV between ISP and ISN.

**CTRL**: Control Pin. An analog voltage from 250mV to 1.25V at this pin programs the regulated voltage between ISP and ISN (and therefore, the regulated current supplied to the load). Alternatively, a digital pulse at this pin with duty cycle from 12.5% to 62.5% can be used to program the regulated voltage. Below 200mV or 10% duty cycle, the CTRL pin voltage disables switching. For more detail, see Regulated LED Current in Typical Performance Curves and Programming LED Current with the CTRL Pin in Applications Information.

**V<sub>REF</sub>**: Reference Voltage Pin. This pin provides a buffered 2V reference capable of 1mA drive. It can be used to supply resistor networks for setting the voltages at the CTRL and PWM pins. Bypass with a 2.2μF capacitor to GND.

**FB**: Feedback Pin. When the voltage at this pin is near 1V, the regulated current is automatically reduced from the programmed value. A resistor network between this pin and V<sub>OUT</sub> can be used to set a limit for the output voltage. If the voltage at the FB pin reaches 1.05V, an overvoltage lockout comparator disables switching.

**FAULT**: Fault Pin. Connect to INTV<sub>CC</sub> through a resistance of 100k. When the FB pin voltage is less than 200mV, an internal switch pulls this pin low to indicate a short-circuit. When FB is greater than 950mV and the voltage between ISP and ISN is simultaneously less than 10mV, the switch pulls this pin low to indicate an open-circuit.

**SS**: Soft-Start Pin. At startup and recovery from fault conditions, a 20μA current charges the capacitor and the FB voltage tracks the rising voltage at this pin until the load current reaches its programmed level. Typical values for the capacitor are 10nF to 100nF. A resistor from SS to INTV<sub>CC</sub> is used to select one of several fault modes. See Soft-Start and Fault Modes in Applications Information for more details.

**V<sub>C</sub>**: Compensation Pin. A capacitor connected from this pin to GND stabilizes the current and voltage regulation. See Stabilizing the Regulation Loop in the Applications Information section for more details.

**SW**: Switch Pins. These two pins are internally connected to the power devices and drivers. They should always be tied together. In normal operation, the voltage of these pins will switch between the input voltage and zero at the programmed frequency. Do not force any voltage on these pins.

**RT**: Timing Resistor Pin. A resistor from this pin to GND programs the switching frequency between 200kHz and 2MHz. Do not leave this pin open.

## PIN FUNCTIONS

**SYNC/SPRD:** Synchronization Pin. To override the programmed switching frequency, drive this pin with an external clock having a frequency between 200kHz and 2MHz. Even when using the external clock, select an  $R_T$  resistor that corresponds to the desired switching frequency. Tie the pin to  $INTV_{CC}$  to enable spread spectrum frequency modulation. This pin should be tied to GND when not in use.

**BST:** Boost Pin. This pin supplies the high side power switch driver. Connect a 22nF capacitor between this pin and SW, and connect a diode from  $INTV_{CC}$  to BST to charge the capacitor when the SW pin is low.

**PWM:** PWM Input Pin. With the RP pin tied to GND, drive this pin with a digital pulse to control PWM dimming of the LEDs. Alternatively, set the voltage of this pin between 1V and 2V to generate an internal pulse with duty ratio between 0% and 100%. In this case, place a 1 $\mu$ F bypass capacitor between this pin and GND. Tie this pin high when PWM dimming is not required.

**PWMTG:** PWM Driver Output Pin. This pin can drive the gate of an external, high side PMOS device for PWM dimming of LEDs. Do not force any voltage on this pin.

**RP:** PWM Resistor Pin. Connect a resistor from this pin to GND to set the frequency of the internal PWM signal. Do not use a resistor larger than 1M $\Omega$ . If using an external PWM pulse for LED dimming, tie this pin to GND.

**V<sub>OUT</sub>:** PWM Driver Supply Pin. This pin supplies an internal regulator for the driver of the external PMOS device. Tie this pin to the output voltage even if dimming is not required.

**GND:** Ground Pins. These must be soldered to the ground plane of the circuit board.

**BLOCK DIAGRAM**

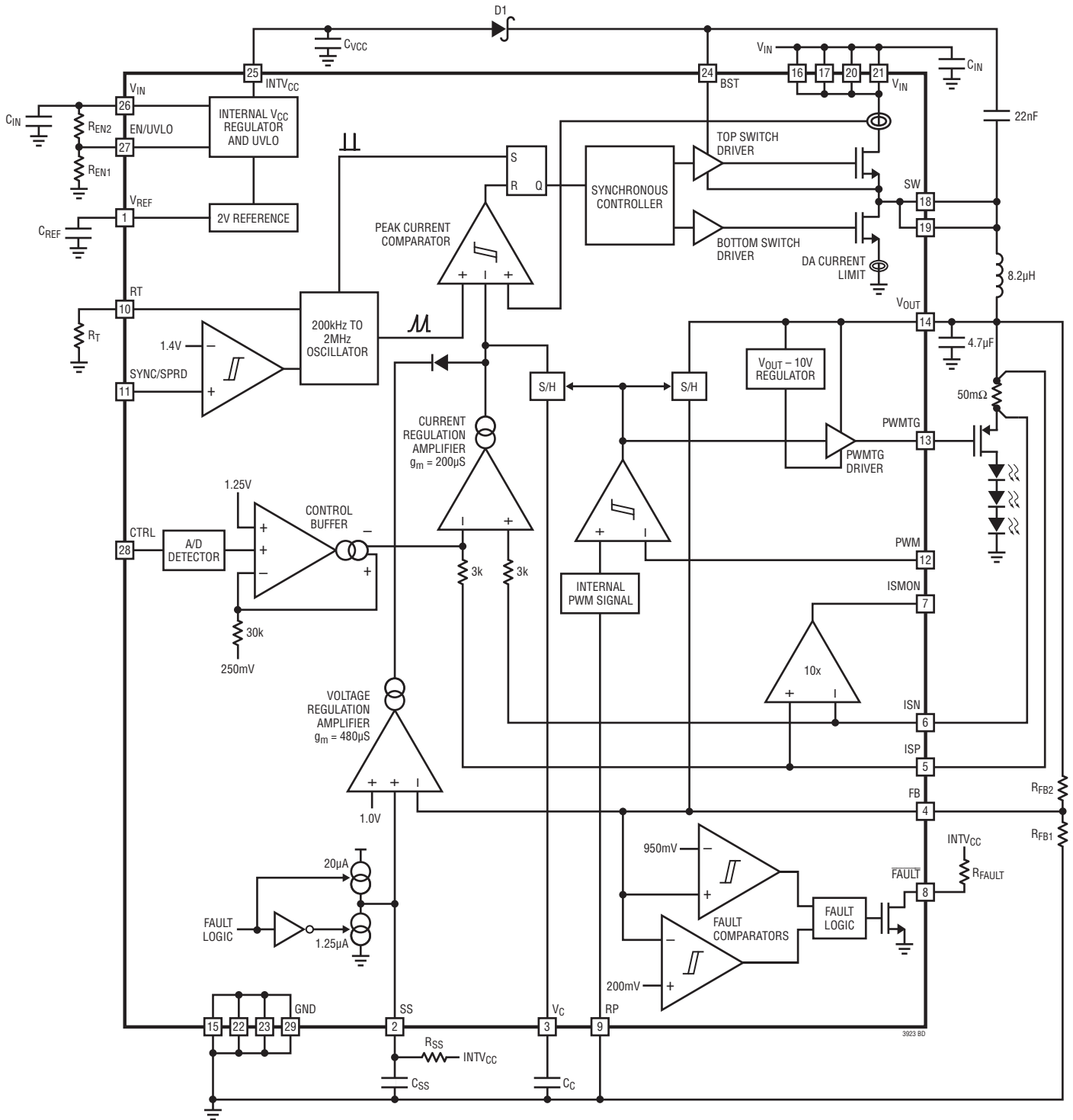

3923 BD

## OPERATION

The LT3932 is a step-down LED driver that utilizes fixed-frequency, peak-current control to accurately regulate the current through a string of LEDs. It includes two power switches and their drivers. The switches connect an external inductor at the SW pin alternately to the input supply and then to ground. The inductor current rises and falls accordingly and the peak current can be regulated by adjusting the duty ratio of the power switches through the combined effect of the other circuit blocks.

The synchronous controller ensures the power switches do not conduct at the same time, and a programmable oscillator turns on the top switch at the beginning of each switching cycle. The frequency of this oscillator is set by an external resistor at the RT pin and can be overridden by external pulses at the SYNC/SPRD pin. The SYNC/SPRD pin can also be used to command spread spectrum frequency modulation (SSFM), which reduces radiated and conducted electromagnetic interference (EMI).

The top switch is turned off by the peak current comparator which waits during the on-time for the increasing inductor current to exceed the target set by the voltage at the  $V_C$  pin. This target is modified by a signal from the oscillator which stabilizes the inductor current. A capacitor at the  $V_C$  pin is necessary to stabilize this regulation loop.

The target for the inductor current is derived from the desired LED current programmed by the voltage at the CTRL pin. The analog-to-digital detector and the control buffer convert either a DC voltage or digital pulses at the CTRL pin into the input for the current regulation

amplifier. The other input to this amplifier comes from the ISP and ISN pin voltages. An external current sense resistor between these pins should be placed in series with the string of LEDs such that the voltage across it provides the feedback to regulate the LED current. The current regulation amplifier then compares the actual LED current to the programmed LED current and adjusts  $V_C$  as necessary.

The voltage regulation amplifier overrides the current regulation amplifier, when the FB pin voltage approaches an internal 1V reference. An external resistor network from the LED string to the FB pin provides an indication of the LED string voltage and allows the voltage amplifier to prevent overvoltage of the LED string.

The FB voltage is also monitored to detect fault conditions like open and short-circuits, which are then reported by pulling the FAULT pin low. The response to a fault can be selected either to try hiccup restarts or to latch-off by the choice of an external resistor connected to the SS pin. Refer to Applications Information for a detailed explanation of fault responses.

Finally, pulse-width-modulation (PWM) of the LED current is achieved by turning on and off an external PMOS switch between the inductor and the string of LEDs. An external pulse at the PWM pin controls the state of the PWM driver, or a DC voltage at the PWM pin dictates the duty ratio of an internal PWM pulse, whose frequency is programmed by an external resistor at the RP pin. After each pulse, when the PMOS switch is open, the LT3932 preserves the voltages of the capacitors at  $V_C$  and  $V_{OUT}$  to ensure a rapid recovery for the next pulse.

## APPLICATIONS INFORMATION

The following is a guide to selecting the external components and configuring the LT3932 according to the requirements of an application.

### Programming LED Current with the CTRL Pin

The primary function of the LT3932 is to regulate the current for a string of LEDs. This current should pass through a series current sense resistor that can be placed anywhere in the string. Then the voltage across this resistor will be sensed by the current regulation amplifier through the ISP and ISN pins and regulated to a level programmed by the CTRL pin. The maximum resistor voltage that can be programmed is 100mV, which corresponds to 2A through the LED string when a 50mΩ current sense resistor is used.

To allow for this maximum current, the CTRL pin may be connected directly to the V<sub>REF</sub> pin, which provides an accurate 2V reference. Lower current levels can be

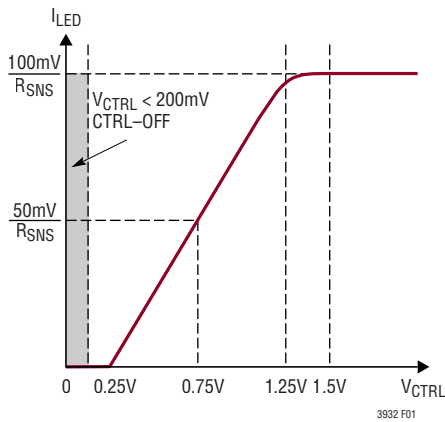

Figure 1. Analog CTRL Range

programmed by DC CTRL voltages between 250mV and 1.25V as shown in Figure 1.

Below 250mV, the CTRL pin commands zero LED current, and above 1.25V, it commands the maximum. When an independent voltage source is not available, the intermediate CTRL voltages may be derived from the 2V reference at the V<sub>REF</sub> pin using a resistor network or potentiometer as long as the total current drawn from the V<sub>REF</sub> pin is less than 1mA.

Additionally, the LT3932 is capable of interpreting a pulse at the CTRL pin. The high level of the pulse must be greater than 1.6V. The low level must be less than 400mV. The frequency must be greater than 100kHz and less than 1MHz. Then the regulated voltage between ISP and ISN will vary with the duty ratio of the pulse as shown in Figure 2.

In this case, the LED current is zero for duty ratios less than 12.5% and reaches its maximum above 62.5%. The LT3932 will cease switching if the duty ratio of the CTRL pin pulse is less than 10%, and also for DC CTRL pin voltages less than 200mV.

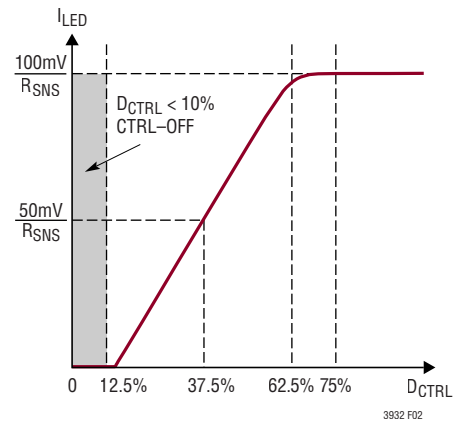

Figure 2. Duty Ratio CTRL Range

To reduce the LED current when the temperature of the LEDs rises, use resistors with negative temperature coefficient (NTC) in the network from V<sub>REF</sub> to CTRL as shown in Figure 3.

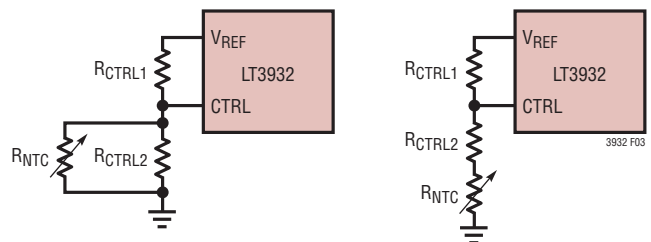

Figure 3. Setting CTRL with NTC Resistors

## APPLICATIONS INFORMATION

### Setting Switching Frequency with the RT Pin

The switching frequency of the LT3932 is programmed by a resistor connected between the RT pin and GND. Values of the  $R_T$  resistor from 45.3k up to 523k program frequencies from 2MHz down to 200kHz as shown in Table 1. Higher frequencies allow for smaller external components but increase switching power losses and radiated EMI.

**Table 1.  $R_T$  Resistance Range**

SWITCHING FREQUENCY	$R_T$
2.0MHz	45.3k
1.6MHz	59.0k
1.2MHz	80.6k
1.0MHz	97.6k
750kHz	133k
500kHz	205k
400kHz	255k
300kHz	348k
200kHz	523k

### Synchronizing Switching Frequency

The switching frequency can also be synchronized to an external clock connected to the SYNC/SPRD pin. The high level of the external clock must be at least 1.4V, and the frequency must be between 200kHz and 2MHz. The  $R_T$  resistor is still required in this case, and the resistance should correspond to the frequency of the external clock. If the external clock ever stops, the LT3932 will rely on the  $R_T$  resistor to set the frequency.

### Enabling Spread Spectrum Frequency Modulation

Connecting SYNC/SPRD to INTV<sub>CC</sub> will enable spread spectrum frequency modulation (SSFM). The switching frequency will vary from the frequency set by the  $R_T$  resistor to 125% of that frequency. If neither synchronization nor SSFM is required, connect SYNC/SPRD to GND.

As shown in Figure 4, enabling SSFM can significantly attenuate the electromagnetic interference that the LT3932, like all switching regulators, emits at the switching frequency and its harmonics. This feature is designed to help devices that include the LT3932 perform better in the various standard industrial tests related to interference.

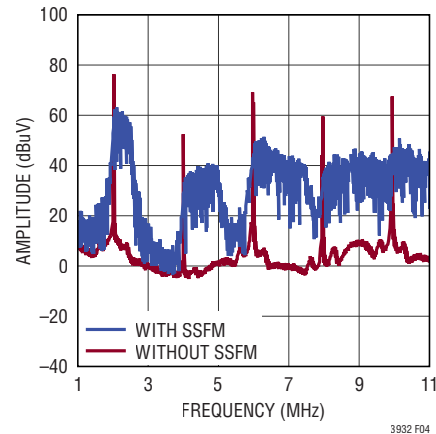

**Figure 4. Typical Average Conducted Emissions**

The attenuation varies depending on the chosen switching frequency, the range of frequencies in which interference is measured, and whether a test measures peak, quasi-peak, or average emissions. The results of several other such emission measurements are with select Typical Applications.

### Understanding the Current Limit

The choice of switching frequency should be made knowing that, although the maximum LED current that can be programmed with the CTRL pin is 2A, the inductor current may exceed 2A when the frequency is high and the output voltage is low as in a short-circuit. This is because there is a minimum on-time for which the SW pin will be driven high during each switching period. The inductor current increases during this time, and if the frequency is high and the output voltage low, there may not be enough off-time remaining in each switching period for the inductor current to decrease back to the level at which it started. In this case, the net inductor current would increase with each switching period regardless of the state of the CTRL pin.

To prevent large inductor currents that would damage the LT3932, the high-side switch is not turned on until the inductor current decreases to less than the DA current limit, which is approximately 2.3A. While the high-side switch is off, the current is sensed through the low-side switch. The peak inductor current may increase to 3.6A, but the off-time and the switching period are extended until the inductor current reaches equilibrium as shown in Figure 5.

## APPLICATIONS INFORMATION

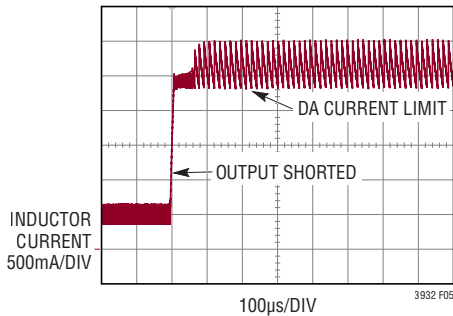

Figure 5. Extended Off-Time at Current Limit

The DA current limit is relevant only when the output capacitor is shorted to GND. When instead the LED string is shorted to GND, the voltage across the external PMOS (described later) is high enough that the required on-time is greater than the minimum on-time. This means that, in spite of a shorted LED string, the inductor current remains in regulation even at the highest switching frequency.

### Selecting an Inductor

The inductor must be rated for the current limit regardless of the intended application. Its value, in most applications, should be selected such that the inductor current ripple is not more than 25% of the maximum output current. When that current is 2A, for example, the minimum inductance can be calculated using the following equation:

$$L = 2\mu\text{H} \cdot \frac{V_{\text{OUT}}}{V_{\text{IN(MAX)}}} \cdot \frac{V_{\text{IN(MAX)}} - V_{\text{OUT}}}{1\text{V}} \cdot \frac{1\text{MHz}}{f_{\text{SW}}}$$

However, for high output voltages even the above equation would suggest an inductance value that is too small. For stability, the LT3932 requires an inductance greater than:

$$L = 1\mu\text{H} \cdot \frac{V_{\text{OUT}}}{1\text{V}} \cdot \frac{1\text{MHz}}{f_{\text{SW}}}$$

Choose the larger of the values given by these equations. The manufacturers featured in Table 2 are recommended sources of inductors.

Table 2. Inductor Manufacturers

MANUFACTURER	WEBSITE
Würth Elektronik	www.we-online.com
Coilcraft	www.coilcraft.com

### Selecting an Output Capacitor

Some applications are sensitive to ripple current in the LED string. In those cases, a capacitor at the output will absorb part of the inductor current ripple and thereby reduce the LED current ripple. Typically, the value of this capacitance is inversely proportional to the switching frequency and the output voltage as shown below:

$$C_{\text{OUT}} = 100\mu\text{F} \cdot \frac{1\text{V}}{V_{\text{OUT}}} \cdot \frac{1\text{MHz}}{f_{\text{SW}}}$$

However, applications may still be stable with more or less capacitance, and more capacitance may improve LED current waveforms for large PWM dimming ratios.

Use X7R or X5R ceramic capacitors as they retain their capacitance better than other capacitor types over a wide voltage and temperature range. Sources of quality ceramic and electrolytic capacitors are listed in Table 3.

Table 3. Capacitor Manufacturers

MANUFACTURER	WEBSITE
Murata Manufacturing	www.murata.com
Garrett Electronics	www.garrettelec.com
AVX	www.avx.com
Nippon Chemi-Con	www.chemi-con.co.jp/e

### Stabilizing the Regulation Loop

Stabilizing the regulation loop typically requires only a capacitor  $C_C$  connected from the  $V_C$  pin to GND. For most designs, values between 1nF and 10nF are suitable. When using an output capacitor  $C_{\text{OUT}}$  larger than 10 $\mu\text{F}$ , as is needed for large PWM dimming ratios, a resistor  $R_C$  in series with  $C_C$  may be necessary. Larger values of  $C_{\text{OUT}}$  require larger values of  $R_C$ . See Typical Applications for some examples.

### Selecting and Placing the Input Capacitors

Although they do not impact stability, several capacitors are necessary between  $V_{\text{IN}}$  and GND to properly bypass the input supply voltage. At least 10 $\mu\text{F}$  is required in total, although it does not have to be composed entirely of ceramic capacitors placed very close to the  $V_{\text{IN}}$  pins. However, it is important that a ceramic capacitor be placed



## APPLICATIONS INFORMATION

as close as possible to each of the pairs of  $V_{IN}$  pins (Pins 16 and 17 as well as 20 and 21) and their adjacent GND pins as shown in Figure 6. These two capacitors should be at least  $1\mu\text{F}$  if possible. Because the SW pins lie between the  $V_{IN}$  pins, it is convenient to join the  $V_{IN}$  pins using a trace on the second layer of the circuit board.

Another  $1\mu\text{F}$  capacitor should be placed very close to the remaining  $V_{IN}$  pin (Pin 26), which supplies the internal control circuitry.

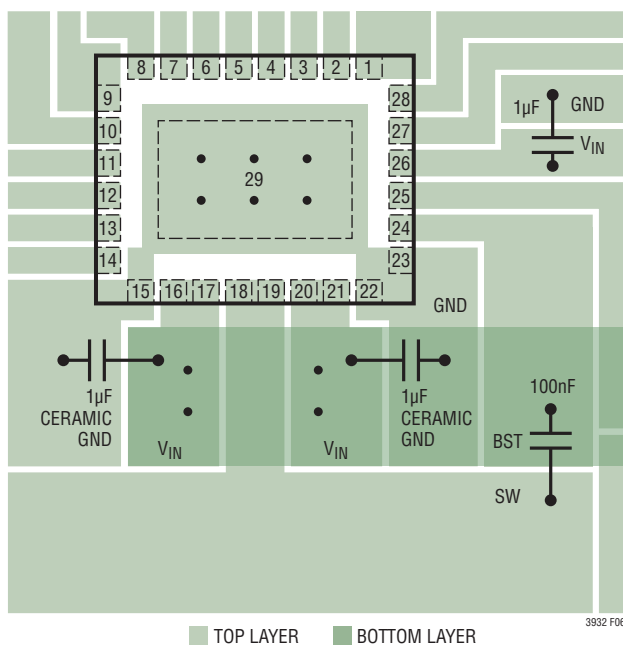

Figure 6. Placement of Input Capacitors

### Selecting a MOSFET for PWM Dimming

Pulse-Width-Modulation (PWM) dimming of the LED current is an effective way to control the brightness of the light without varying its color. The brightness can also be adjusted more accurately this way than by varying the current level.

The LT3932 features a PWM driver that is intended for a high-voltage PMOS switch in position to effectively PWM dim a string of LEDs from the output capacitor and current sense resistor. When the switch is open and the string is disconnected, the LED current will be zero. In

contrast to a low-side NMOS driver, this feature eliminates the need for a dedicated return path for the LED current in automotive applications or other grounded chassis systems.

The gate driver for this PMOS draws power through the  $V_{OUT}$  pin, which must be connected even in applications that do not require PWM dimming. When the PWM pin voltage is greater than 1.4V, the driver will pull the gate of the PMOS to a maximum of 10V below the  $V_{OUT}$  pin. If  $V_{OUT}$  is below 10V, the gate drive is necessarily reduced. For constant current applications, leave PWMTG open, connect the load directly after the current sense resistor, and connect PWM to INTV<sub>CC</sub>. In these cases, analog dimming may be implemented with the CTRL pin.

The drain-source voltage rating of the chosen PMOS should be greater than the maximum output voltage. Typically the output voltage is a little higher than the sum of the forward voltages of the LEDs in the string. However, when the string is broken, the output voltage will begin to increase due to the imbalance of inductor current and load current. As described in detail later, the LT3932 will not reduce the inductor current nor limit the output voltage until the FB pin voltage approaches 1V. Therefore, the maximum output voltage is ultimately determined by the resistor network between FB and  $V_{OUT}$ .

In most applications, the gate-source voltage rating of the PMOS should be at least 10V. The only exceptions to this rule are applications for which the output voltage is always less than 10V. The PWM driver will try to pull the gate of the PMOS down to 10V below  $V_{OUT}$ , but it cannot pull the gate below GND. Therefore, when the maximum output voltage is less than 10V, the PMOS gate source voltage rating will be sufficient if it is merely equal to or greater than the output voltage.

Finally, the drain current rating of the PMOS must exceed the programmed LED current. Assuming this condition and the conditions above are met, the only electrical parameter to be considered is the on-resistance. Other parameters such as gate charge are less important because PWM dimming frequencies are typically too low for efficiency to be affected noticeably by gate charging loss or transition loss.

## APPLICATIONS INFORMATION

Table 4 lists recommended manufacturers of PMOS devices.

**Table 4. PMOS Manufacturers**

MANUFACTURER	WEBSITE
Infineon	www.infineon.com
Vishay Intertechnology	www.vishay.com
NXP Semiconductors	www.nxp.com

### Selecting an R<sub>P</sub> Resistor for Internal PWM Dimming

If the RP pin is tied to GND, an external pulse-width modulated signal at the PWM pin will control PWM dimming of the LED load. The signal will enable the PWMTG driver and turn on the external PMOS device when it is higher than 1.4V.

However, the LT3932 is capable of PWM dimming even when an external PWM signal is not available. In this case, an internal PWM signal with frequency set by a resistor at the RP pin and duty ratio set by a DC voltage at the PWM pin will control the PWMTG driver. The R<sub>P</sub> resistor should be one of the seven values listed in Table 5. For each of these values, the PWM frequency is a unique ratio of the switching frequency.

**Table 5. Internal PWM Dimming Frequencies**

R <sub>P</sub>	SWITCHING FREQUENCY			
	2MHz	1MHz	500KHz	250KHz
28.7k	7.81kHz	3.91kHz	1.95kHz	977Hz
47.5k	3.91kHz	1.95kHz	977Hz	488Hz
76.8k	1.95kHz	977Hz	488Hz	244Hz
118k	977Hz	488Hz	244Hz	122Hz
169k	488Hz	244Hz	122Hz	61Hz
237k	244Hz	122Hz	61Hz	31Hz
332k	122Hz	61Hz	31Hz	15Hz

When using the internal PWM signal, set the voltage at the PWM pin between 1V and 2V. The PWMTG driver will stay off if PWM is below 1V, and it will stay on if PWM is above 2V. Between 1V and 2V there are 128 evenly spaced thresholds corresponding to 128 discrete PWM duty ratios from 0% to 100%. This range of 1V to 2V has been chosen so that the PWM voltage may be set using a potentiometer or a resistor network and the 2V reference available at the V<sub>REF</sub> pin. Place a small 1μF ceramic capacitor near the PWM pin to ground.

There are a couple of exceptions to the PWM dimming behavior described above. First, once initiated, the PWM on-time will last at least four switching cycles regardless of the signal at the PWM pin and the resistor at the RP pin. This ensures that the current regulation loop has enough time to reach equilibrium but still allows for a 5000:1 dimming ratio when the PWM frequency is 100Hz and the switching frequency is 2MHz. *The LT3932-1 does not enforce this four-cycle limit so that dimming ratios of 10000:1 or greater are possible in some applications.* Second, to avoid excessive start-up times, after the first PWM pulse, PWMTG will stay on until the SS pin voltage reaches 1.7V or the LED current has reached 10% of the full-scale current.

### PWM Dimming with Very Long Off Times

To enhance PWM dimming, the V<sub>OUT</sub> and V<sub>C</sub> pin voltages are driven when the PWM pulse (internal or external) is at a logic low to maintain the charge on the capacitors at those pins. Consequently, when PWM returns to a logic high state, the LED current can quickly reach the regulated level even if PWM was low for a very long time. This feature facilitates machine vision applications which require a synchronized strobe light or brief illuminating flashes on short delay.

### Monitoring LED Current

The ISMON pin provides an amplified and buffered monitor of the voltage between the ISP and ISN pins. The gain of the internal amplifier is ten, and the speed is fast enough to track the pulse-width modulated LED current. However, as shown in Figure 7, the ISMON voltage can be filtered with a resistor-capacitor network to monitor the average LED current instead.

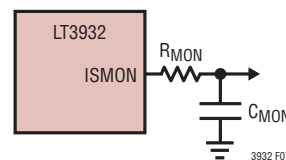

**Figure 7. ISMON Filter Configuration**

## APPLICATIONS INFORMATION

The resistor should be 1MΩ. The capacitance can be as large or small as needed without affecting the stability of the internal amplifier. For example, when the PWM frequency is 200Hz, a 100nF capacitor combined with the 1MΩ resistor would limit the ripple on ISMON to 1%.

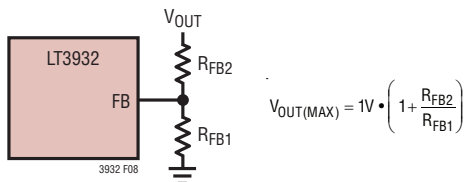

Figure 8. FB Resistor Configuration

### Selecting the FB Resistors

Two resistors should be selected to form a network between the output voltage and the FB pin as shown in Figure 8.

This network forms part of a voltage regulation loop when FB is nearly 1V. In this case, the LT3932 will override the programmed LED current to lower the output voltage and limit FB to 1V. This resistor configuration therefore determines the maximum output voltage.

Note that this voltage limit may be reached inadvertently if it is set too close to the typical output voltage and the output capacitor is too small. To avoid interference with the current regulation, the feedback resistors should be chosen such that FB is about 700mV when the LEDs are conducting.

For a 12V string of LEDs, design for a maximum output voltage of about 17V. Start with a 10k resistor for R<sub>FB1</sub>. To calculate the value of R<sub>FB2</sub>, add 10k for every volt of difference between FB (1V) and the maximum output voltage. In this case, the nearest standard 1% value for R<sub>FB2</sub> would be 162k.

In this way, the LT3932 can also be configured as a voltage regulator instead of an LED driver. It will regulate the output voltage near the programmed maximum as long as the load current is less than the current level programmed by CTRL.

### Understanding FB Overvoltage Lockout

It is possible that the FB voltage can exceed the 1V limit. If the output voltage is near the maximum when the LED string opens, it may take too long for the feedback loop to adjust the inductor current and avoid overcharging the output. However, if the FB voltage exceeds the 1.05V Overvoltage Lockout Threshold, the LT3932 will immediately stop switching and resume only when FB decreases to 1V.

This threshold may be routinely exceeded when the LT3932 is being operated as a voltage regulator and the load current decreases rapidly. In this case, the pause in switching limits the output overshoot and ensures that the voltage is back in regulation as quickly as possible. For safe operation, choose R<sub>FB2</sub> and R<sub>FB1</sub> values to ensure the output voltage is not greater than V<sub>IN</sub> when the FB voltage is 1.05V.

### Open and Shorted LED Fault Detection and Response

The resistor network formed by R<sub>FB1</sub> and R<sub>FB2</sub> also defines the criteria for two fault conditions with respect to the LED string: short and open-circuits. For the LT3932, a short-circuit is when FB is less than 200mV. An open-circuit is when FB is greater than 950mV and simultaneously the difference between ISP and ISN is less than 10mV (the C/10 threshold). The latter condition ensures that the output current is low (as it should be in an open-circuit) not just that output voltage is high as it may be when the LEDs are conducting a large current.

In both cases, a fault is indicated by an internal device pulling the voltage at the FAULT pin low. There is nothing internal that pulls this voltage high, so an external resistor between INTV<sub>CC</sub> and FAULT is necessary as shown in Figure 9. This configuration allows multiple FAULT pins and similar pins on other parts to be connected and share a single resistor.

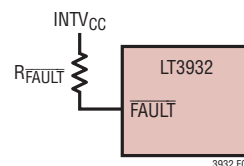
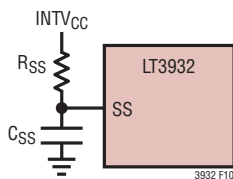

Figure 9. FAULT Resistor Configuration

## APPLICATIONS INFORMATION

### Soft-Start and Fault Modes

The SS pin has two functions. First, it allows the user to program the output voltage startup ramp rate. An internal  $20\mu\text{A}$  current pulls up the SS pin to  $\text{INTV}_{\text{CC}}$ . Connecting an external capacitor  $C_{\text{SS}}$  from the SS pin to GND, as shown in Figure 10, will generate a linear ramp voltage. The LT3932 regulates the FB pin voltage to track the SS pin voltage until  $V_{\text{OUT}}$  is high enough to drive the LED at the commanded current level.



**Figure 10. SS Capacitor and Resistor Configuration**

The SS pin is also used as a fault timer. After a fault is detected, an internal  $1.25\mu\text{A}$  current sink will begin to discharge the soft-start capacitor and lower the voltage at the SS pin. When the voltage falls from  $3.3\text{V}$  to  $1.7\text{V}$ , all switching will cease, but the SS pin will continue to discharge. Switching will not resume until SS reaches  $200\text{mV}$ . At this point, the  $20\mu\text{A}$  current will recharge the soft-start capacitor, and the LT3932 will try to switch again. If the fault persists when SS returns to  $1.7\text{V}$ , the process will repeat as shown in Figure 11.

The charging rate of the soft-start capacitor is much faster than the discharging rate, so while the fault persists, the LT3932 will only attempt switching for a relatively short

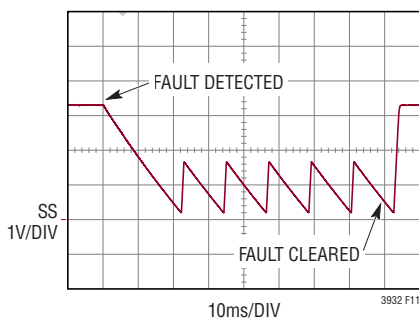

**Figure 11. Hiccup Response to Fault**

part of the cycle before being interrupted. Although the LT3932 can safely endure a short-circuit while continuously switching, this hiccup action saves power. The frequency of the hiccups is inversely proportional to  $C_{\text{SS}}$  and  $100\text{nF}$  yields about  $8\text{Hz}$ .

The operating point of a voltage regulator supplying light loads will frequently satisfy the criteria for an open-circuit, and the hiccup behavior would therefore be very disruptive. So when the LT3932 is configured as a voltage regulator, a resistor  $R_{\text{SS}}$  should be connected between  $\text{INTV}_{\text{CC}}$  and SS as shown in Figure 10.

The current that pulls down the SS pin during a fault is so weak that if  $R_{\text{SS}}$  is  $1\text{M}\Omega$ , the voltage at the SS pin will never reach  $1.7\text{V}$ . Therefore, the LT3932 will not stop switching or start to hiccup. With this resistor, the LT3932 will continue switching and rely on overvoltage and over-current protection to guarantee safe operation in the event of open-circuits and short-circuits.

If the resistor is changed to  $2\text{M}\Omega$ , then the SS pin may be discharged to less than  $1.7\text{V}$ , but not less than  $200\text{mV}$  as shown in Figure 12. The LT3932 will consequently cease switching permanently until being reset by the EN/UVLO pin or by powering off. Some applications may demand this behavior so that short and open-circuits can be investigated manually before resuming normal operation.

This latch-off behavior is the third of three ways that the LT3932 can be programmed to respond to faults—the other two being continuous operation and the default hiccup behavior.

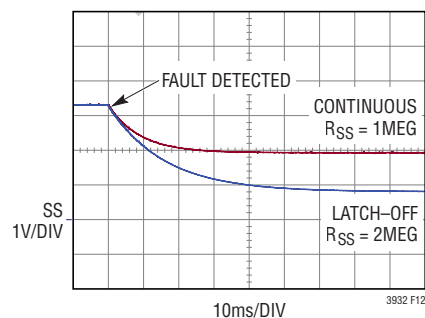

**Figure 12. Latch-Off Response to a Fault**

## APPLICATIONS INFORMATION

### Dimming with External Drivers

Continuous operation in response to a fault also enables the LT3932 to operate with external switches that shunt some or all of the LEDs in the string. The LT3965 8-switch Matrix LED Dimmer, for example, is designed to shunt a changing combination of up to eight LEDs in a single string with independent PWM dimming signals. See Typical Applications for more details.

### Programming the EN/UVLO Threshold

An external voltage source can be used to set the voltage at the EN/UVLO pin to enable or disable the LT3932. The LT3932 will stop switching, disable the PWM driver, and reset the SS pin when the voltage at EN/UVLO drops below 1.15V, but internal circuitry will continue drawing current. Full shutdown is guaranteed when EN/UVLO is below 300mV, and in full shutdown the LT3932 will draw less than 2 $\mu$ A. For applications in which the level of the source driving EN/UVLO changes slowly, 20mV of hysteresis has been added to the 1.15V enable threshold.

Alternatively, a resistor network can be placed between  $V_{IN}$  and EN/UVLO as shown in Figure 13. In this case, EN/UVLO automatically falls below 1.15V and disables

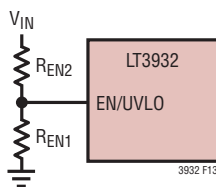

Figure 13. EN/UVLO Resistor Configuration

switching when  $V_{IN}$  falls below a certain level, called the Undervoltage Lockout (UVLO) threshold, which is defined by resistors  $R_{EN1}$  and  $R_{EN2}$ . Additionally, a 4 $\mu$ A current is designed to flow into EN/UVLO when the pin voltage is below the threshold. This current provides additional hysteresis. To define the hysteresis ( $V_{HYST}$ ) and the UVLO threshold ( $V_{UVLO}$ ) select  $R_{EN1}$  and  $R_{EN2}$  according to the following equations:

$$R_{EN2} = \frac{V_{HYST}}{4\mu A} - \frac{V_{UVLO}}{480\mu A}$$

$$R_{EN1} = \frac{1.15 \cdot R_{EN2}}{V_{UVLO} - 1.15}$$

For example, to program a 10V threshold with 1V of hysteresis, use 226k and 29.4k for  $R_{EN2}$  and  $R_{EN1}$ , respectively.

### Planning for Thermal Shutdown

The LT3932 automatically stops switching when the internal temperature is too high. The temperature limit is guaranteed to be higher than the operational temperature of the part. During thermal shutdown, all switching is terminated, SS is forced low, and the LEDs are disconnected using the PWM driver.

The exposed pad on the bottom of the package must be soldered to a ground plane. Vias placed directly under the package are necessary to dissipate heat. Following these guidelines, the official four-layer demo board DC2286A reduces thermal resistance  $\theta_{JA}$  to 25°C/W, but with a compromised board design  $\theta_{JA}$  could be 40°C/W or higher.

## APPLICATIONS INFORMATION

### Designing the Printed Circuit Board

Note that large switched currents flow through the local input capacitors and the  $V_{IN}$  and GND pins. The loops traveled by these currents should be made as small as possible by keeping the capacitors as close as possible to these pins. These capacitors, as well as the inductor, should be placed on the same side of the board as the LT3932 and connected on the same layer. Other large, bulk input capacitors can be safely placed farther from the chip and on the other side of the board.

Create a Kelvin ground network by keeping the ground connection for all of the other components separate. It should only join the ground for the input and output capacitors and the return path for the LED current at the exposed pad.

There are a few other aspects of the board design that improve performance. An unbroken ground plane on the second layer dissipates heat, but also reduces noise. Likewise minimizing the area of the SW and BST nodes reduces noise. The traces for FB and  $V_C$  should be kept short to lessen the susceptibility to noise of these high impedance nodes. Matched kelvin connections from the external current sense resistor  $R_S$  to the ISP and ISN pins are essential for current regulation accuracy. The  $2.2\mu\text{F}$  INTV<sub>CC</sub> and  $V_{REF}$  capacitors as well as the 22nF BST capacitor should be placed as closely as possible to their respective pins. A capacitor for the CTRL pin and, when the internal dimming feature is used, the PWM pin, can compensate for compromised layouts. Finally, a diode with anode connected to ground and cathode to the drain of the PWMTG MOSFET can protect that device from over-voltage caused by excessive inductance in the LED string. Please refer to the demo board layout of the LT3932 for an example of how to implement these recommendations.

# TYPICAL APPLICATIONS

## 2A LED Driver with Duty Cycle LED Current

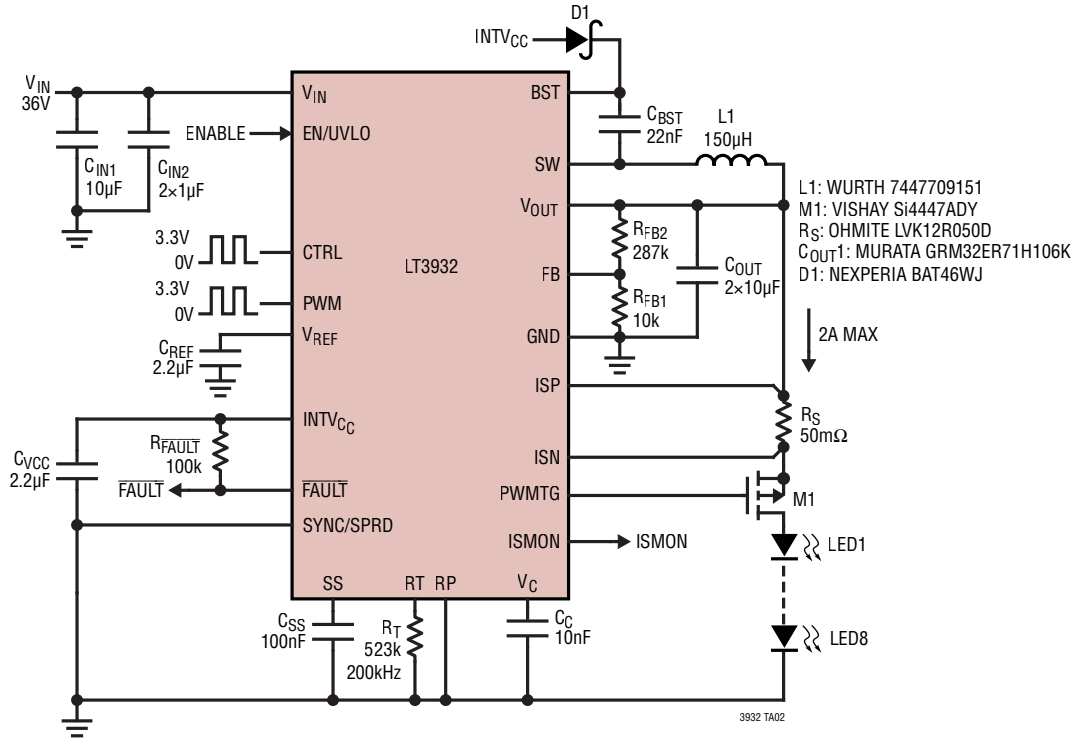

**Digital CTRL 25%,  
Digital PWM 100%**

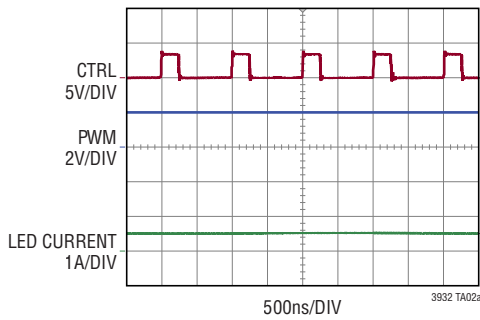

**Digital CTRL 50%,  
Digital PWM 100%**

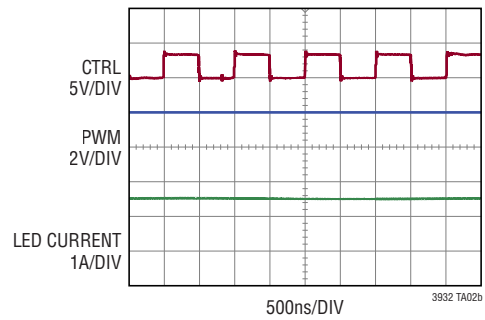

**Digital CTRL 25%,  
Digital PWM 25%**

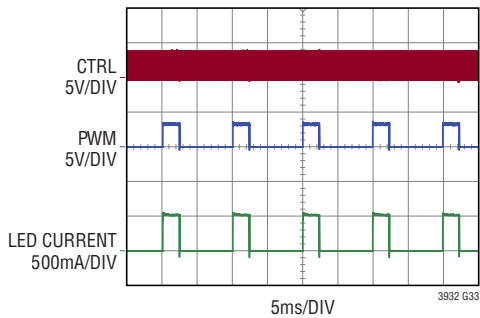

**Digital CTRL 25%,  
Digital PWM 50%**

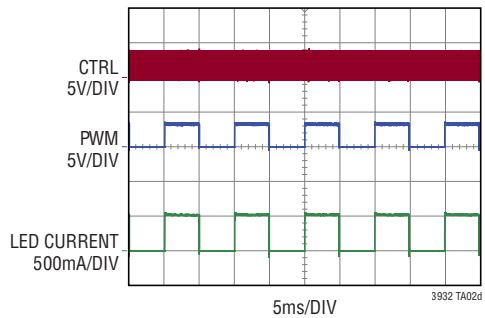

## TYPICAL APPLICATIONS

### 24V Voltage Regulator with Spread Spectrum

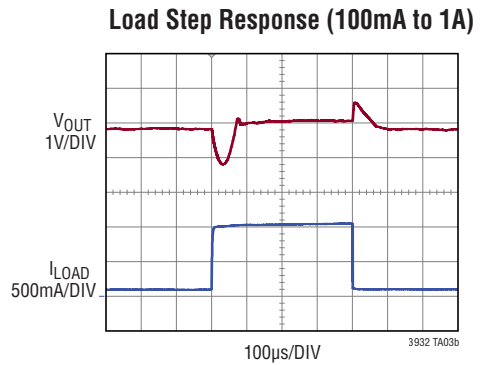
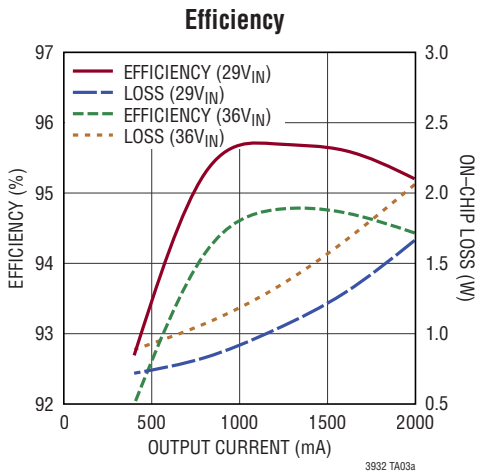
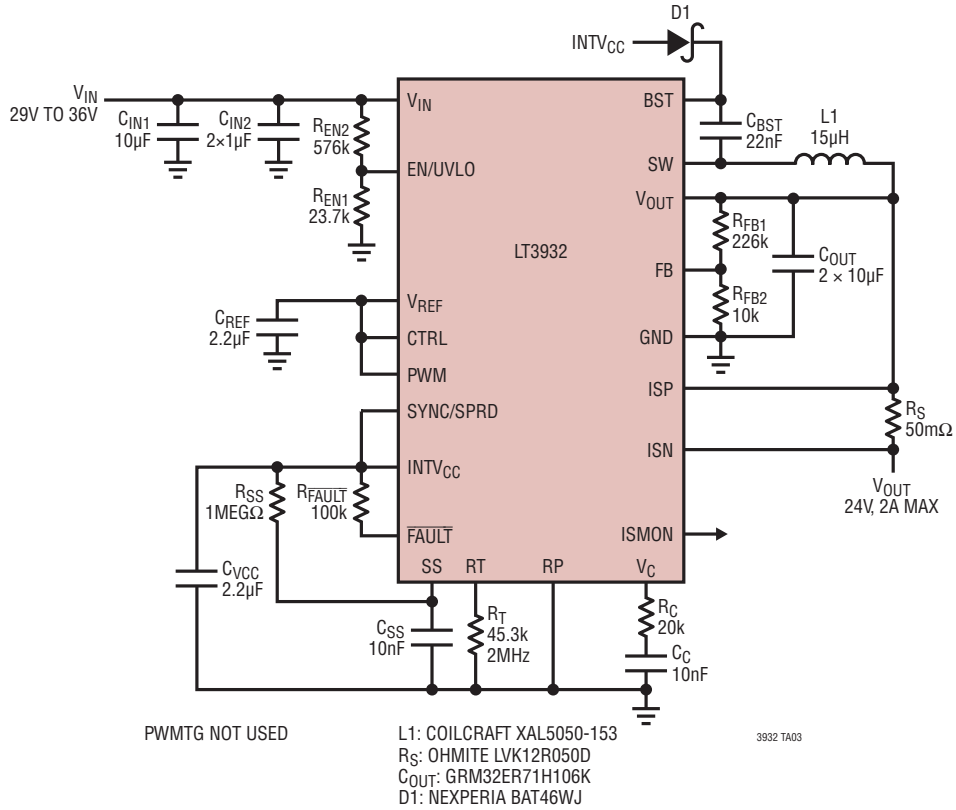



TYPICAL APPLICATIONS

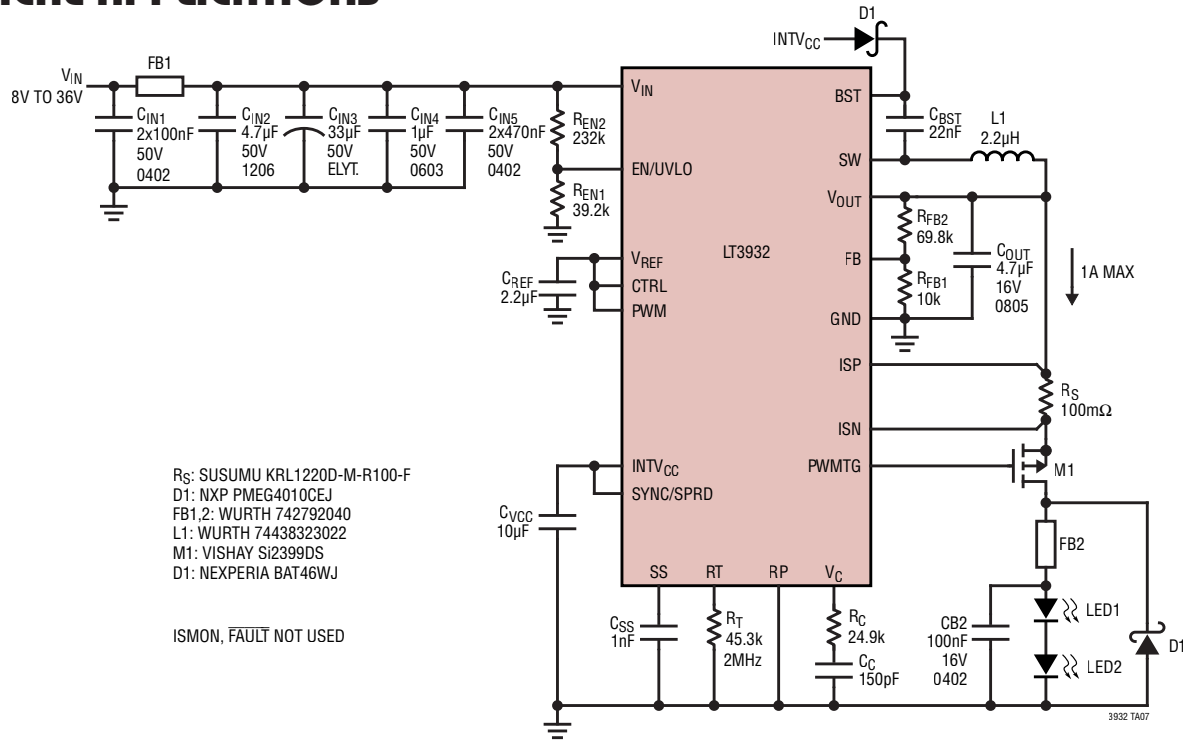

CISPR25 Peak Conducted Emissions Test

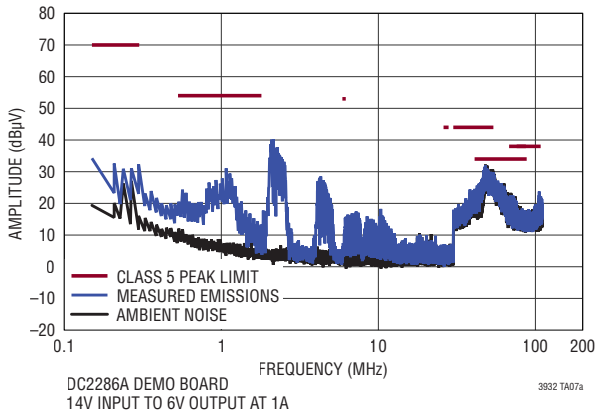

CISPR25 Peak Radiated Emissions Test

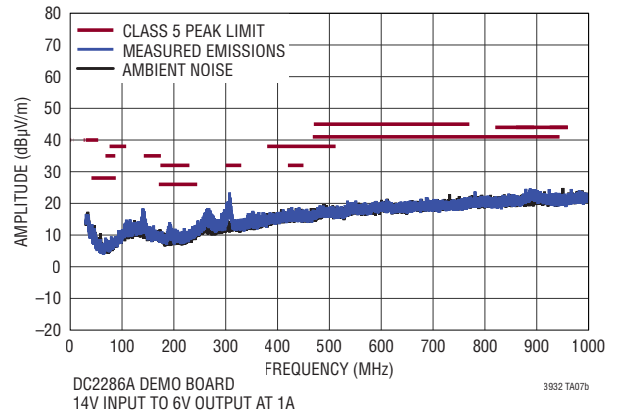

CISPR25 Average Conducted Emissions Test

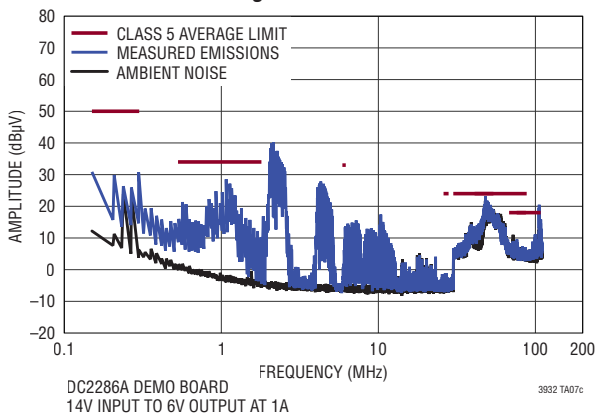

CISPR25 Average Radiated Emissions Test

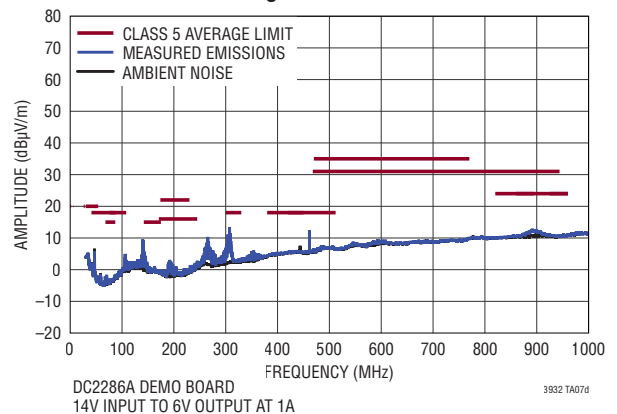

## TYPICAL APPLICATIONS

### 2A LED Driver with Internal PWM Dimming

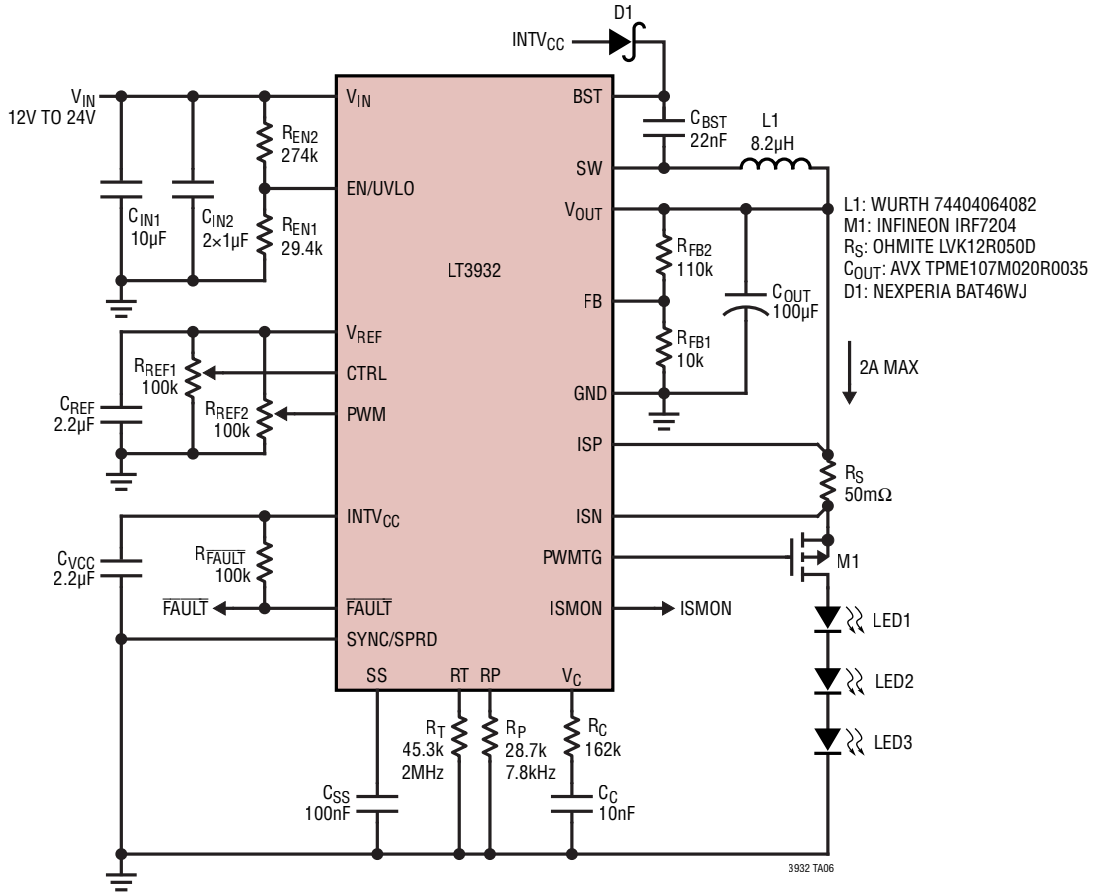

Internal PWM Dimming

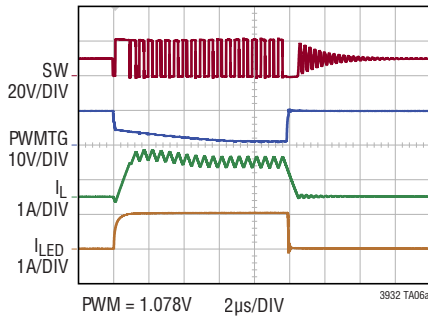

Internal PWM Dimming

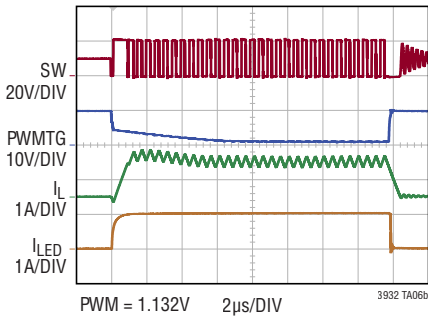

TYPICAL APPLICATIONS

Multiple String Drivers from Single Boosted 36V Input

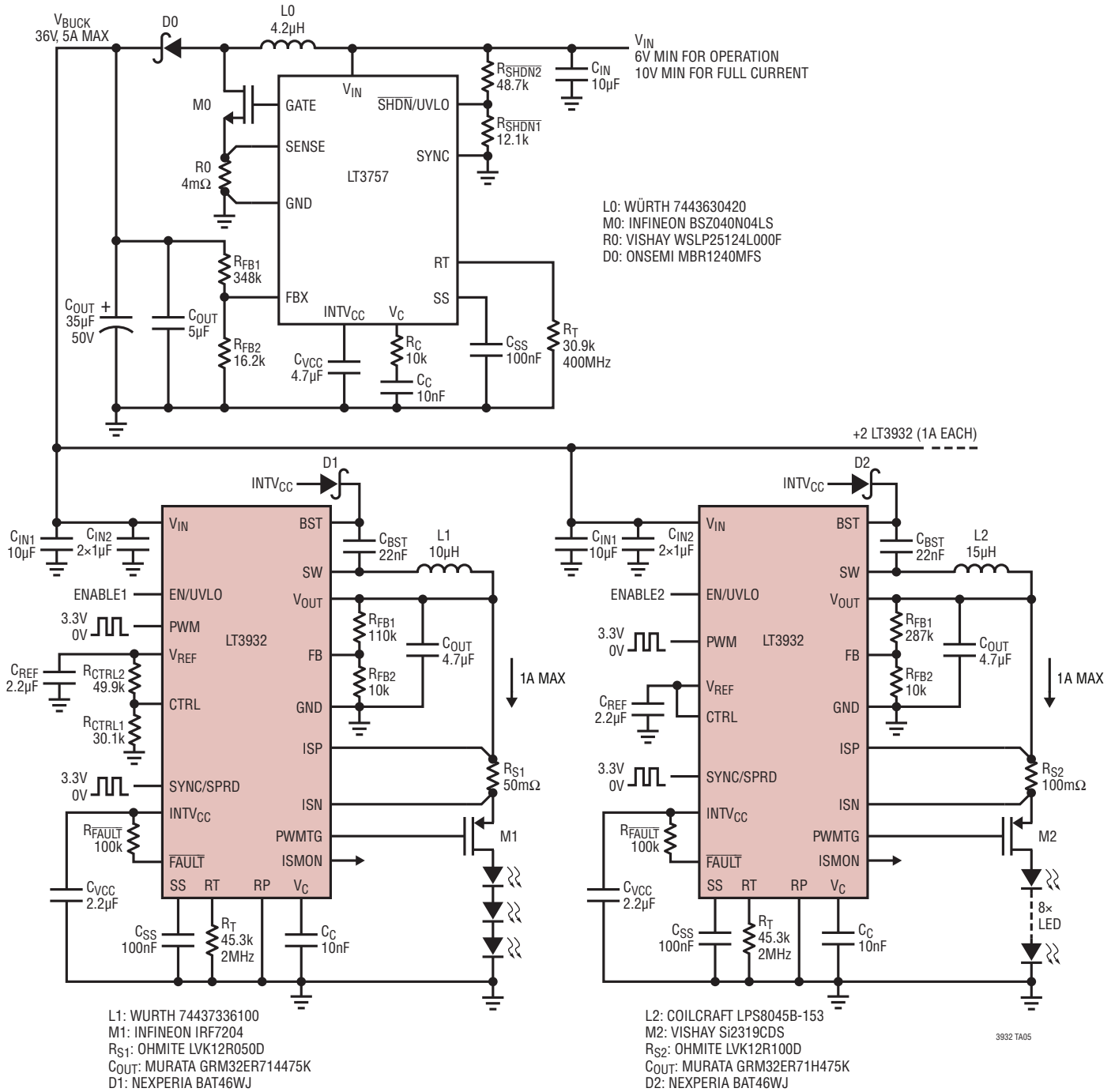

3932 TA05

**PACKAGE DESCRIPTION**

**UFD Package**  
**28-Lead Plastic QFN (4mm × 5mm)**  
 (Reference LTC DWG # 05-08-1712 Rev C)

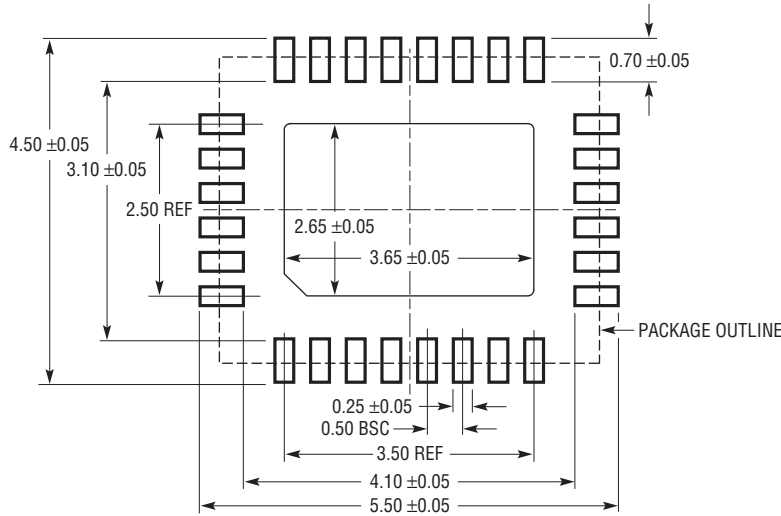

RECOMMENDED SOLDER PAD PITCH AND DIMENSIONS  
 APPLY SOLDER MASK TO AREAS THAT ARE NOT SOLDERED

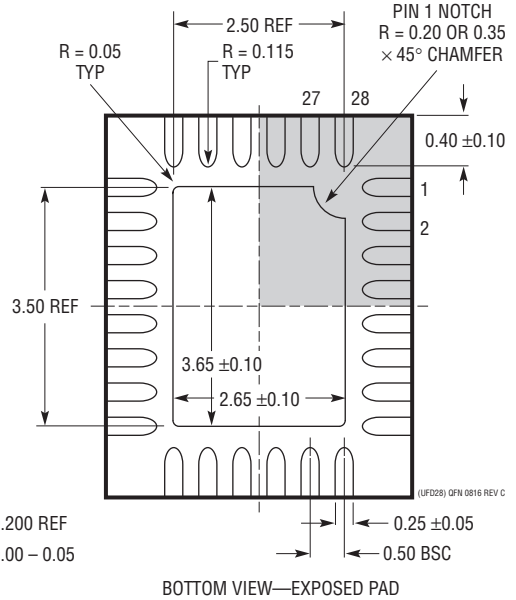
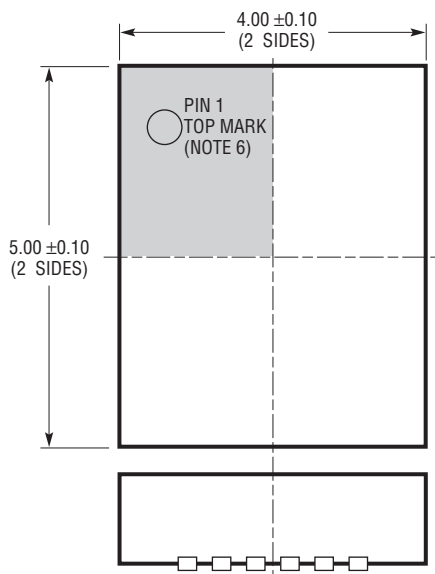

- NOTE:
1. DRAWING PROPOSED TO BE MADE A JEDEC PACKAGE OUTLINE MO-220 VARIATION (WGHD-3).
  2. DRAWING NOT TO SCALE
  3. ALL DIMENSIONS ARE IN MILLIMETERS
  4. DIMENSIONS OF EXPOSED PAD ON BOTTOM OF PACKAGE DO NOT INCLUDE MOLD FLASH. MOLD FLASH, IF PRESENT, SHALL NOT EXCEED 0.15mm ON ANY SIDE
  5. EXPOSED PAD SHALL BE SOLDER PLATED
  6. SHADED AREA IS ONLY A REFERENCE FOR PIN 1 LOCATION ON THE TOP AND BOTTOM OF PACKAGE

## REVISION HISTORY

REV	DATE	DESCRIPTION	PAGE NUMBER
A	02/18	Added LT3932-1 to data sheet.	1
		Added 10000:1 PWM dimming ratio for LT3932-1 with supporting text in Features and Description.	1
		Added machine vision systems to Applications.	1
		Relabeled Soft-Start pin from S to SS.	1, 22, 24, 25, 28
		On Figure, added Schottky Diode from INTV <sub>CC</sub> to BST pin, changed boost capacitor from 100nF to 22nF.	1, 12, 22, 23, 24, 25, 26, 28
		Changed $\theta_{JA}$ from 43°C/W to 25°C/W (based on demo board measurement).	2
		Sense voltage V <sub>CTRL</sub> changed from 2V to 1.5V. ISN pin current V <sub>ISN</sub> value changed from 24V to 23.9V.	3
		LED Current and LED Voltage Limit Graphs y-axis corrected to mV units.	7
		DA Limit graph retitled to “DA Current Limit”, input step changed from 20V upper limit to 25V on Input Voltage Transient Response graph.	9
		Added additional BST pin description text; corrected BST capacitor value from 100nF to 22nF.	11
		DA Current Limit added to Block Diagram.	12
		Text added to describe DA Current Limit.	15
		Added LT3932-1 text regarding four-cycle limit and machine vision usage.	18
		Added text regarding $\theta_{JA}$ equals 25°C/W using DC2286 demo board, corrected boost capacitor value.	21
		Corrected Typical Application figure, reduced V <sub>OUT</sub> from 30V to 24V, changed digital CTRL 50% graph y-axis from 5A/DIV to 5V/DIV.	22
		Add new Efficiency graph.	23
Added Diode D1: Nexperia BAT46WJ.	22, 24, 25, 26, 28		
B	07/18	Three revised UVLO graphs in Typical Performance Characteristics	5
		EN/UVLO description; Changed text from “A resistor network between this pin and GND” to “. . . this pin and V <sub>IN</sub> .”	10
		V <sub>REF</sub> description; Changed buffered reference drive current from 2mA to 1mA	10
		Corrected R <sub>SS</sub> from 1mΩ to 1MΩ	24
		Changed Inductor L1 value from 7438323022 to 74438323022	25
		Increased Inductor value from 8.2μH to 10μH	27
		Changed Inductor; New Product Number; Changed L1 From 7440463082 to 74437336100	27

# LT3932/LT3932-1

## TYPICAL APPLICATION

### 700mA Matrix LED Driver with Individual Dimming for 6 LEDs

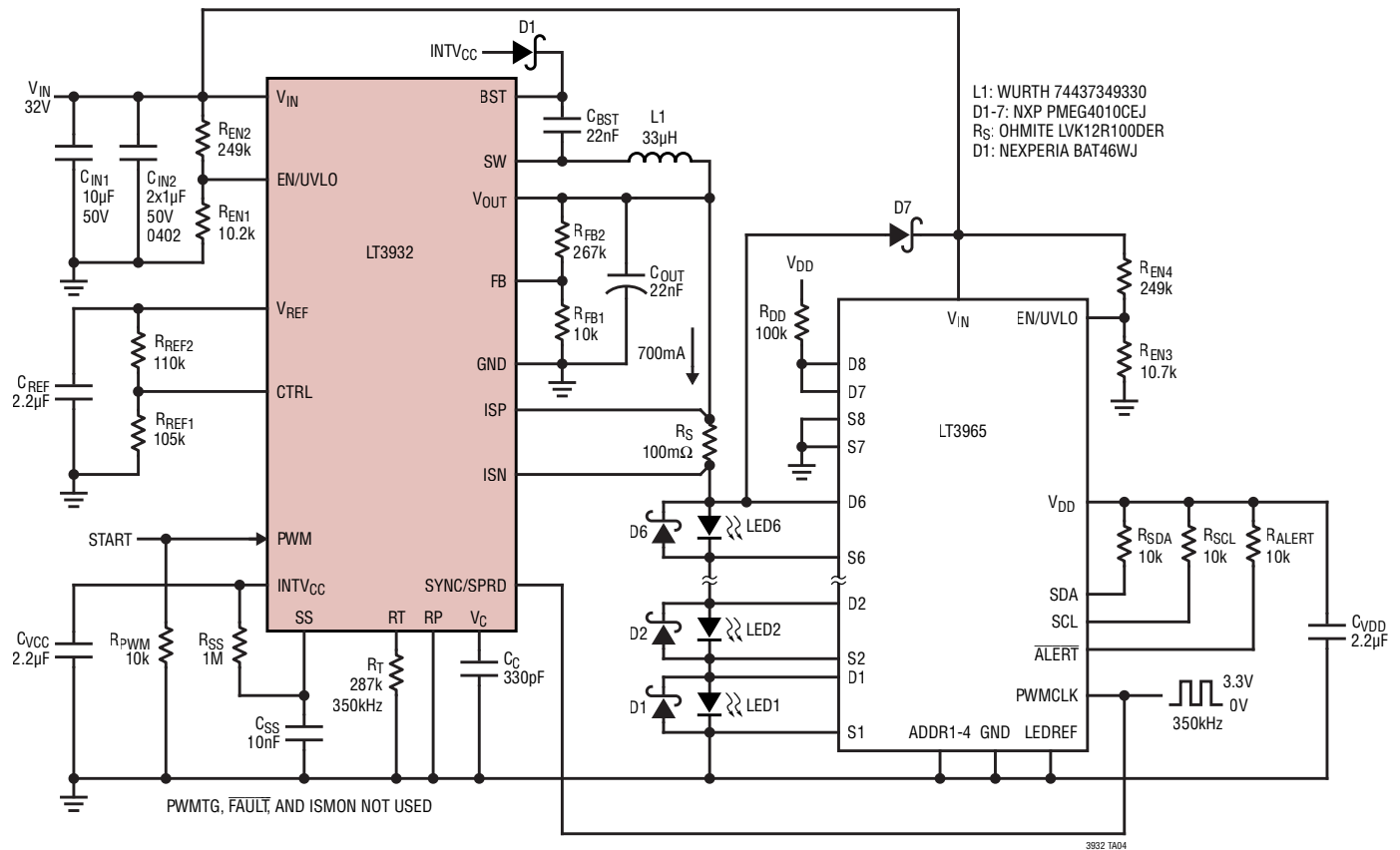

## RELATED PARTS

PART NUMBER	DESCRIPTION	COMMENTS
<a href="#">LT3922</a>	40V, 2A, 2MHz, Synchronous Boost LED Driver	$V_{IN}$ : 2.7V to 40V, $V_{OUT(MAX)}$ = 40V, 5000:1 True Color PWM™ Dimming, 5mm × 5mm QFN and TSSOP-28E
<a href="#">LT3965</a>	8-Switch Matrix LED Dimmer	$V_{IN}$ : 8V to 60V, Digital Programmable 256:1 PWM Dimming, I <sup>2</sup> C Multidrop Serial Interface TSSOP-28E Package
<a href="#">LT3956</a>	80V, 3.3A 1MHz, Step-Up/Down LED Driver	$V_{IN}$ : 4.5V to 80V, $V_{OUT(MAX)}$ = 80V, 3000:1 True Color PWM Dimming, 5mm × 6mm QFN
<a href="#">LT3474</a>	36V, 1A, 2MHz, Step-Down LED Driver	$V_{IN}$ : 4V to 36V, $V_{OUT(MAX)}$ = 13.5V, 400:1 True Color PWM Dimming, TSSOP-16E
<a href="#">LT3475</a>	Dual 36V, 1.5A, 2MHz, Step-Down LED Driver	$V_{IN}$ : 4V to 36V, $V_{OUT(MAX)}$ = 13.5V, 3000:1 True Color PWM Dimming, TSSOP-20E
<a href="#">LT3476</a>	Quad 36V, 1.5A, 2MHz, Step-Up/Down LED Driver	$V_{IN}$ : 2.8V to 16V, $V_{OUT(MAX)}$ = 36V, 1000:1 True Color PWM Dimming, 5mm × 7mm QFN
<a href="#">LT3477</a>	42V, 3A, 3.5MHz, Step-Up/Down LED Driver	$V_{IN}$ : 2.5V to 25V, $V_{OUT(MAX)}$ = 40V, 4mm × 4mm QFN and TSSOP-20E
<a href="#">LT3478</a>	42V, 4.5A, 2.5MHz, Step-Up/Down LED Driver	$V_{IN}$ : 2.5V to 26V, $V_{OUT(MAX)}$ = 42V, 3000:1 True Color PWM Dimming, TSSOP-16E
<a href="#">LTM8040</a>	36V, 1A, μModule, Step-Down LED Driver	$V_{IN}$ : 4V to 36V, $V_{OUT(MAX)}$ = 13V, 250:1 True Color PWM Dimming, 9mm × 15mm × 4.32mm LGA
<a href="#">LTM8042</a>	36V, 1A, μModule, Step-Up/Down LED Driver	$V_{IN}$ : 3V to 30V, $V_{OUT(MAX)}$ = 36V, 3000:1 True Color PWM Dimming, 9mm × 15mm × 2.82mm LGA
<a href="#">LT3757</a>	40V, 1MHz, Step-Up Controller	$V_{IN}$ : 2.9V to 40V, Positive and Negative Output Voltages, 3mm × 3mm DFN and MSOP-10E