



# DB(UL) Series

## UL Approved\* Normally Closed, High Voltage Relays - 10kV



- 10kV Isolation
- Low Contact Resistance
- PCB or Panel Mount
- HV connections via Flying Leads, Solder Turret (wire wrap), or 1/4" Spade Terminals
- Excellent AC characteristics



Recently approved by UL, very high isolation voltages (up to 10kV) are achieved through the use of high vacuum reed switches with Tungsten contacts and make these relays suitable for high reliability applications, such as cardiac defibrillators, test equipment and high voltage power supplies.

The Tungsten contact relays can switch higher voltages, up to 7000Vdc/ac peak to peak

PCB or Panel Mount, via Nylon studs, versions are available.

Connection options, for the HV, include PCB, solder turret(wire wrap), flying lead and 0.25" spade terminals.

Contact Specification	Unit	Condition	10kV SPNC		
Contact Form			N/C (normally closed)		
Contact Material			Tungsten		
Isolation across contacts	kV	DC or AC peak	10		
Switching Power Max.	W		50		
Switching Voltage Max.	V	DC or AC peak	7000		
Switching Current Max.	A	DC or AC peak	2		
Carry Current Max	A	DC or AC peak	3		
Capacitance across contacts	pF	coil to screen grounded	<0.2		
Lifetime operations		dry switching	10 <sup>9</sup>		
		50W switching	10 <sup>6</sup>		
Contact Resistance	mΩ	max (typical)	250(100)		
Insulation Resistance	Ω	min (typical)	(10 <sup>15</sup> )		
Coil Specification			5V	12V	24V
Must Operate Voltage	V	DC	3.7	9	20
Must Release Voltage	V	DC	0.5	1.25	4
Operate Time	ms	diode fitted	2.0	2.0	2.0
Release Time	ms	diode fitted	3.0	3.0	3.0
Resistance	Ω		38	240	925
Relay Specification					
Isolation contact/coil	kV		17		
Insulation resistance contact to all terminals	Ω	min (typical)	10 <sup>10</sup> (10 <sup>15</sup> )		
Environmental					
Operating Temp range	°C		-20 to +70		

\*Consult factory for UL ratings

### Part Numbering System

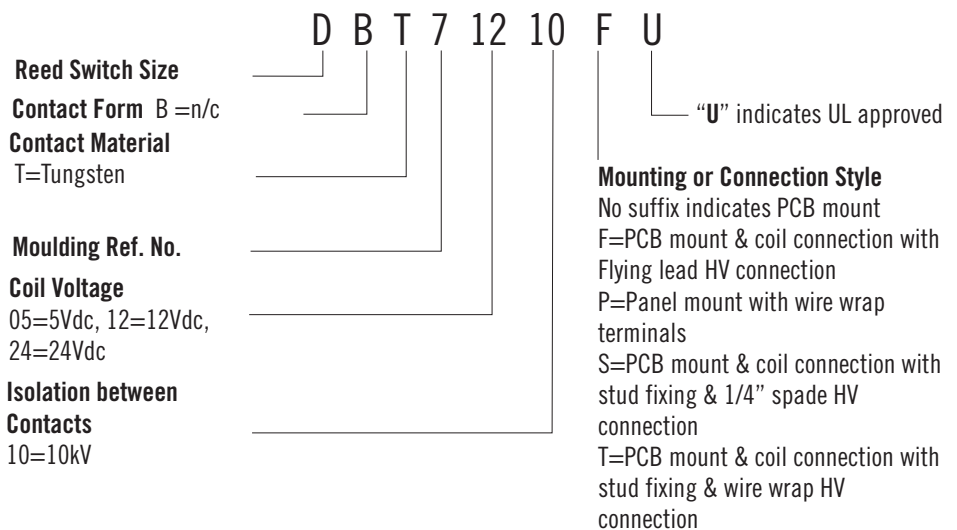

Cynergy3 Components Ltd.  
 7 Cobham Road  
 Ferndown Industrial Estate  
 Wimborne, Dorset BH21 7PE  
 Telephone +44 (0) 1202 897969  
 Email:sales@cynergy3.com

ISO9001 CERTIFIED

DB(UL) 2016

© 2016 Cynergy3 Components, All Rights Reserved. Specifications are subject to change without prior notice. Cynergy3 Components and the Cynergy3 Components logo are trademarks of Cynergy3 Components Limited.

www.cynergy3.com



## MECHANICAL

### STANDARD

(e.g. DBT71210U)

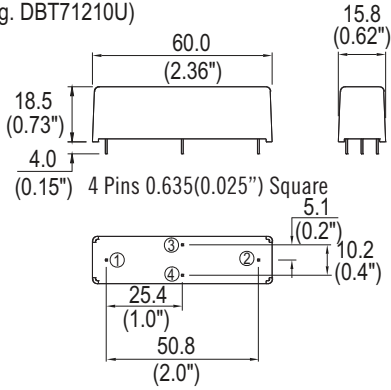

### CIRCUIT DIAGRAMS (ALL VARIANTS)

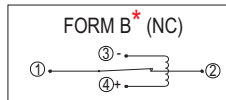

NOTE: COIL POLARITY IS IMPORTANT

### PANEL MOUNT

(e.g. DBT71210PU)

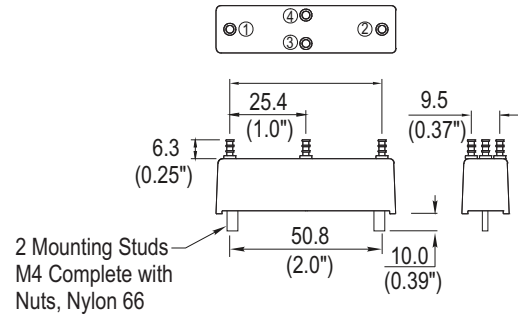

### FLYING LEAD

(e.g. DBT71210FU)

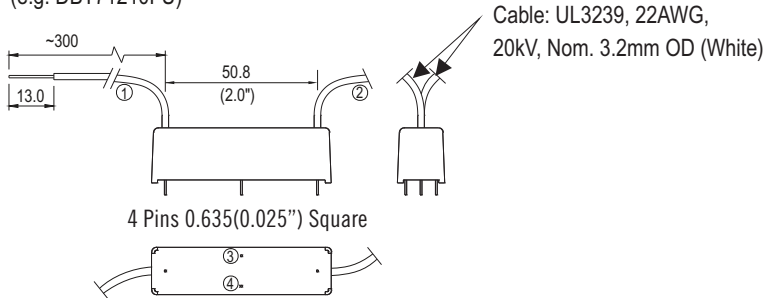

NOTE: PINS WHICH ARE NOT NUMBERED HAVE NO ELECTRICAL CONNECTION.

### TURRET (Wire Wrap)

(e.g. DBT71210TU)

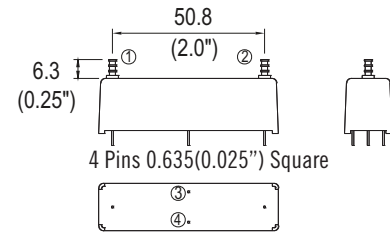

NOTE: PINS WHICH ARE NOT NUMBERED HAVE NO ELECTRICAL CONNECTION.

### SPADE TYPE

(e.g. DBT71210SU)

'S' Suffix denotes the 0.250" 'Push On' blade connectors, M4 fixing bolts and Epoxy potting.

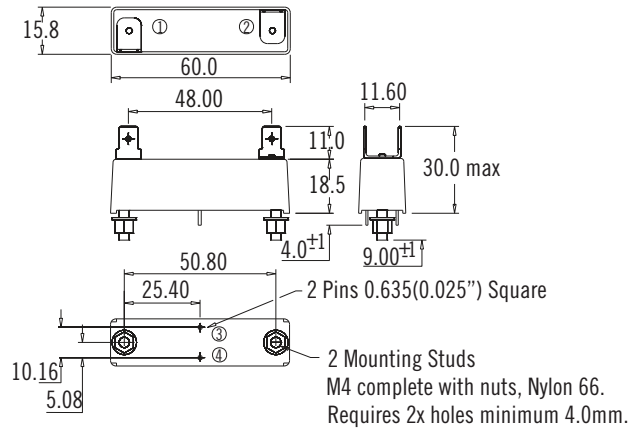

Cynergy3 Components Ltd.  
7 Cobham Road  
Ferndown Industrial Estate  
Wimborne, Dorset BH21 7PE  
Telephone +44 (0) 1202 897969

Email: sales@cynergy3.com

ISO9001 CERTIFIED

www.cynergy3.com