

Description

The AL8862 is a step-down DC/DC converter designed to drive LEDs with a constant current. The AL8862 operates with an input supply voltage from 5V to 60V and provides an externally adjustable output current up to 1A. Series connection of the LEDs provides identical LED currents resulting in uniform brightness and eliminating the need for ballast resistors. The AL8862 switches at frequency up to 1MHz. This allows the use of smaller size external components, hence minimizing the PCB size.

The AL8862 integrates the power switch and a high-side output current sensing circuit. Maximum output current of AL8862 is set via an external resistor connected between the VIN and SET input pins. Dimming is achieved by applying either a DC voltage or a PWM signal at the CTRL input pin. The soft-start time can be adjusted using an external capacitor from the CTRL pin to ground. An input voltage of 0.3V or lower at CTRL pin will shut down the power switch.

Features

- Wide Input Voltage Range: 5V to 60V
- Output Current up to 1A
- Internal 60V NDMOS Switch
- Typical 4% Output Current Accuracy
- Single Pin for On/Off and Brightness Control by DC Voltage or PWM Signal
- High Efficiency (Up to 97%)
- LED Short-Circuit Protection
- Inherent Open-Circuit LED Protection
- Current-Sense Resistor Short-Circuit Protection
- Over Temperature Shutdown
- Up to 1MHz Switching Frequency
- SO-8EP Packages Available in Green Molding Compound (No Br, Sb)
- **Totally Lead-Free & Fully RoHS Compliant (Notes 1 & 2)**
- **Halogen and Antimony Free. "Green" Device (Note 3)**

- Notes:
1. No purposely added lead. Fully EU Directive 2002/95/EC (RoHS) & 2011/65/EU (RoHS 2) compliant.
 2. See http://www.diodes.com/quality/lead_free.html for more information about Diodes Incorporated's definitions of Halogen- and Antimony-free, "Green" and Lead-free.
 3. Halogen- and Antimony-free "Green" products are defined as those which contain <900ppm bromine, <900ppm chlorine (<1500ppm total Br + Cl) and <1000ppm antimony compounds.

Pin Assignments

(Top View)

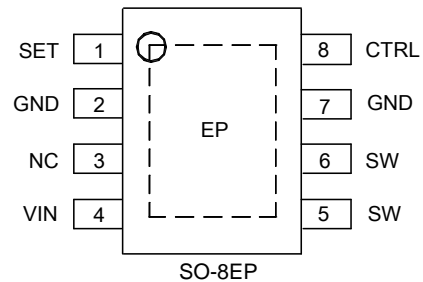

Applications

- Commercial & Industrial Lighting
- Appliances Interior Lighting
- Architecture Detail Lighting
- External Driver with Multiple Channels and Smart Lighting

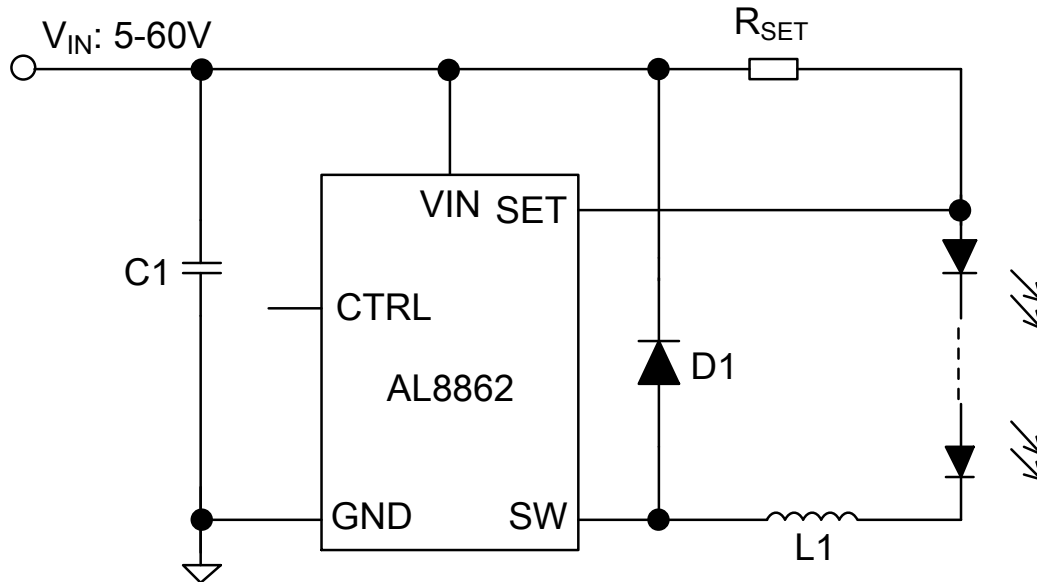
Typical Applications Circuit

Pin Descriptions

Pin Number	Pin Name	Function
1	SET	Set Nominal Output Current Pin. Connect resistor R_{SET} from this pin to V_{IN} to define nominal average output current.
2,7	GND	Ground of IC
3	NC	No connection
4	VIN	Input voltage (5V to 60V). Decouple to ground with 10 μ F or higher X7R ceramic capacitor close to device.
5,6	SW	Switch Pin. Connect inductor/freewheeling diode here, minimizing track length at this pin to reduce EMI.
8	CTRL	Multi-function On/Off and brightness control pin: <ul style="list-style-type: none"> • Leave floating for normal operation. • Drive to voltage below 0.3V to turn off output current • Drive with DC voltage ($0.4V < V_{SET} < 2.5V$) to adjust output current from 10% to 100% of I_{OUT_NOM} • Drive with an analog voltage $>2.6V$ output current will be 100% of I_{OUT_NOM} • A PWM signal (Low level $<0.3V$, High level $>2.6V$, transition times less than 1μs) allows the output current to be adjusted over a wide range up to 100% • Connect a capacitor from this pin to ground to increase soft-start time. (Default soft-start time = 0.1ms. Additional soft-start time is approx. 1.5ms/1nF)
EP	EP	Exposed pad/TAB connects to GND and thermal mass for enhanced thermal impedance.

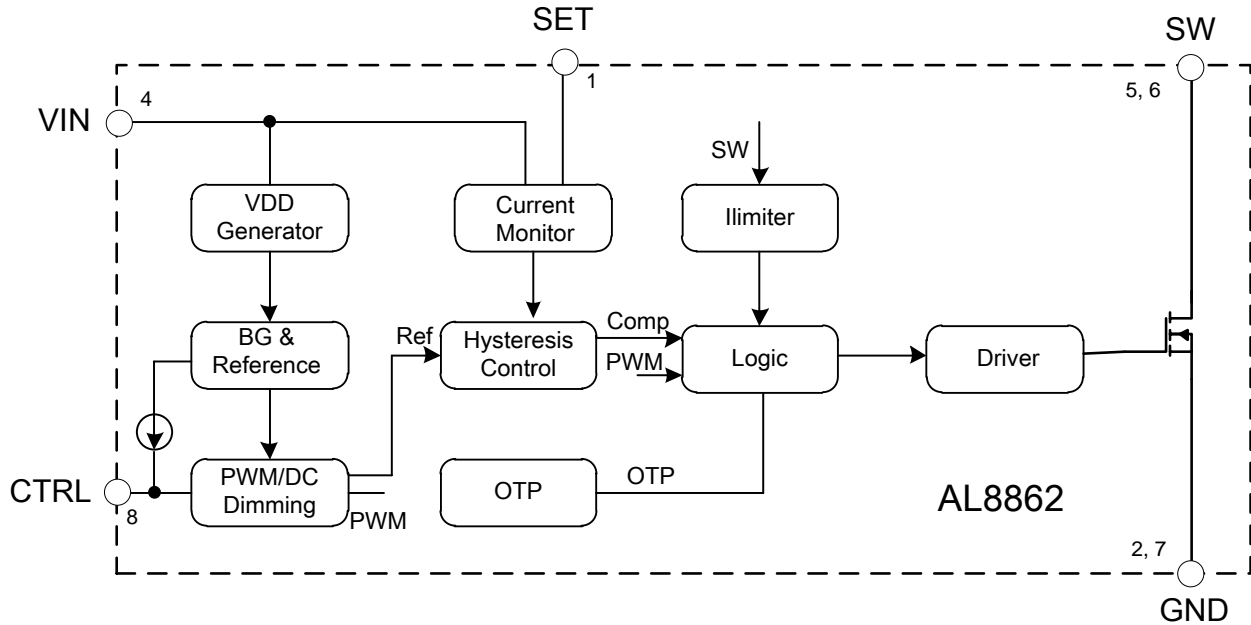
Functional Block Diagram



Absolute Maximum Ratings (Note 4)

Symbol	Parameter	Rating	Unit
V _{IN}	Input Voltage	-0.3 to 65	V
V _{SW} , V _{SET}	SW, SET Pin Voltage	-0.3 to 65	V
V _{CTRL}	CTRL Pin Input Voltage	-0.3 to 6	V
T _A	Operating Ambient Temperature	-40 to +105	°C
T _J	Operating Junction Temperature	-40 to +150	°C
T _{STG}	Storage Temperature Range	-65 to +150	°C
T _{LEAD}	Lead Temperature (Soldering, 10sec)	+300	°C

Note: 4. Stresses greater than those listed under "Absolute Maximum Ratings" may cause permanent damage to the device. These are stress ratings only, and functional operation of the device at these or any other conditions beyond those indicated under "Recommended Operating Conditions" is not implied. Exposure to Absolute Maximum Ratings for extended periods may affect device reliability.

NEW PRODUCT

ESD Ratings

Symbol	Parameter	Rating	Unit
V _{ESD}	Human-Body Model (HBM)	2000	V
	Charged-Device Model (CDM)	500	

Recommended Operating Conditions

Symbol	Parameter	Min	Max	Unit
V _{IN}	Input Voltage	5	60	V
F _{SW}	Switching Frequency	-	1	MHz
I _{OUT}	Continuous Output Current	-	1	A
V _{CTRL}	Voltage Range for 10% to 100% DC Dimming Relative to GND	0.4	2.5	V
V _{CTRL_HIGH}	Voltage High for PWM Dimming Relative to GND	2.6	5.5	V
V _{CTRL_LOW}	Voltage Low for PWM Dimming Relative to GND	0	0.3	V
T _A	Operating Ambient Temperature	-40	+105	°C
T _J	Operating Junction Temperature	-40	+125	°C

Thermal Information (Note 5)

Symbol	Parameter	Rating	Unit
θ _{JA}	Junction-To-Ambient Thermal Resistance	65	°C/W
θ _{JC}	Junction-To-Case(Top) Thermal Resistance	22.4	°C/W

Note: 5. Device mounted on 2" × 2" FR-4 substrate PCB, 2oz copper, with minimum recommended pad layout.

Electrical Characteristics ($T_A = +25^\circ\text{C}$, unless otherwise noted.)

Symbol	Parameter	Conditions	Min	Typ	Max	Unit
SUPPLY VOLTAGE						
V_{IN}	Input Voltage	-	5.0	-	60	V
I_Q	Quiescent Current	CTRL Pin Floating, $V_{IN} = 16\text{V}$	-	450	-	μA
V_{UVLO}	Under Voltage Lockout	V_{IN} Rising	-	4.8	-	V
V_{UVLO_HYS}	UVLO Hysteresis	-	-	200	-	mV
HYSTERESTIC CONTROL						
V_{SET}	Mean Current Sense Threshold Voltage	Measured on SET Pin with Respect to V_{IN}	96	100	104	mV
V_{SET_HYS}	Sense Threshold Hysteresis	-	-	± 13	-	%
I_{SET}	ISET Pin Input Current	$V_{SET} = V_{IN} - 0.1$	-	8	-	μA
ENABLE AND DIMMING						
V_{CTRL}	Voltage Range on CTRL Pin	For Analog Dimming	0.4	-	2.5	V
-	Analog Dimming Range	-	10	-	100	%
V_{CTRL_ON}	DC Voltage on CTRL Pin for Analog Dimming on	V_{CTRL} Rising	-	0.45	-	V
V_{CTRL_OFF}	DC Voltage on CTRL Pin for Analog Dimming off	V_{CTRL} Falling	-	0.40	-	V
SWITCHING OPERATION						
R_{ON}	SW Switch On Resistance	@ $I_{SW} = 100\text{mA}$	-	0.4	-	Ω
I_{SW_LEAK}	SW Switch Leakage Current	-	-	-	8	μA
t_{SS}	Soft Start Time	$V_{IN} = 16\text{V}$, $C_{CTRL} = 1\text{nF}$	-	1.5	-	ms
F_{SW}	Operating Frequency	$V_{IN} = 16\text{V}$, $V_O = 9.6\text{V}$ (3 LEDs) $L = 47\mu\text{H}$, $\Delta I = 0.25\text{A}$ ($I_{LED} = 1\text{A}$)	-	250	-	kHz
F_{SW_MAX}	Recommended Maximum Switch Frequency	-	-	-	1	MHz
t_{ON_REC}	Recommended Minimum Switch ON Time	For 4% Accuracy	-	500	-	ns
t_{PD}	Internal Comparator Propagation Delay (Note 6)	-	-	100	-	ns
THERMAL SHUTDOWN						
T_{OTP}	Over Temperature Protection	-	-	+150	-	$^\circ\text{C}$
T_{OTP_HYS}	Temp Protection Hysteresis	-	-	+30	-	$^\circ\text{C}$
I_{SW_MAX}	Current Limit	Peak Inductor Current	-	3	-	A

Note: 6 .Guaranteed by design.

Typical Performance Characteristics ($T_A = +25^\circ\text{C}$, $V_{IN} = 16\text{V}$, unless otherwise noted.)

Quiescent Current vs. Input Voltage

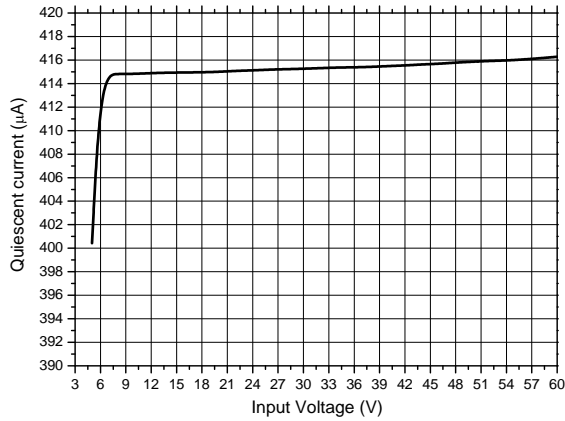

Quiescent Current vs. Temperature

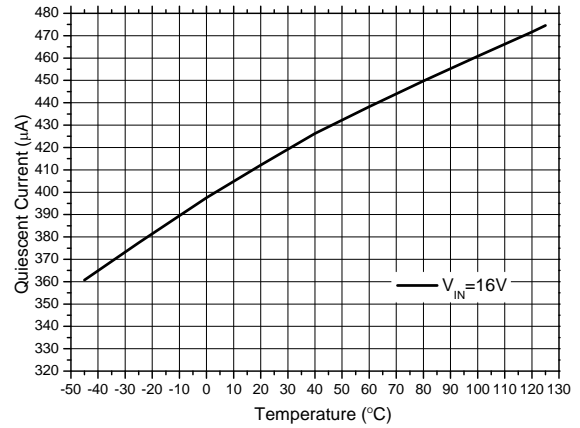

SET Threshold Voltage vs. Input Voltage

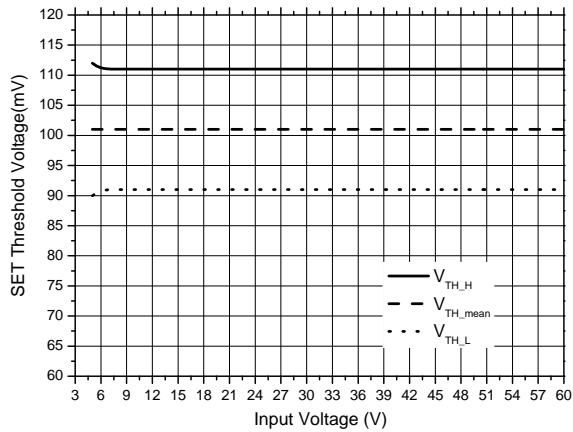

SET Threshold Voltage vs. Temperature

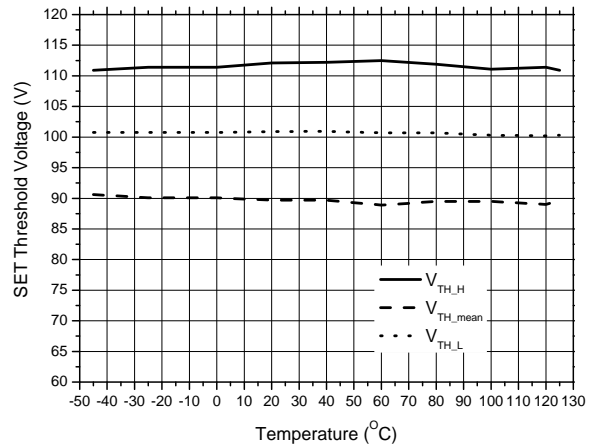

PWM Dimming ($V_{IN}=16\text{V}$, 3LEDs, $68\mu\text{H}$, $R_s=0.3\Omega$)
Output Current vs. Duty Cycle

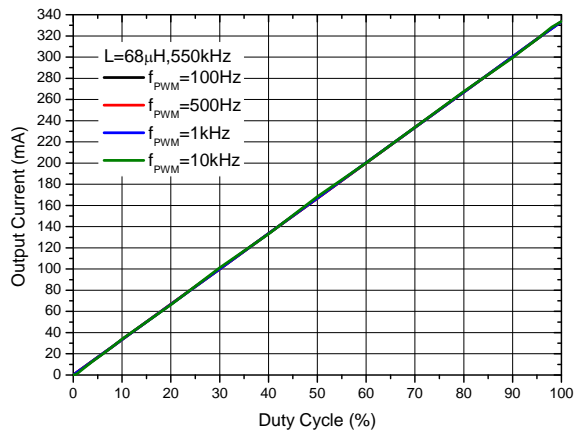

Analog Dimming ($V_{IN}=16\text{V}$, 3LEDs, $47\mu\text{H}$, $R_s=0.3\Omega$)
LED Current vs. CTRL Pin Voltage

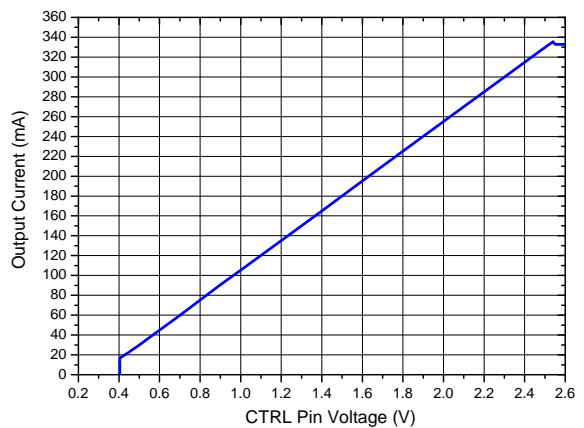

Typical Performance Characteristics (Cont.) ($T_A = +25^\circ\text{C}$, $V_{IN} = 16\text{V}$, unless otherwise noted.)

NEW PRODUCT

Efficiency vs. Input Voltage
($R_s=0.3\Omega$, $L=100\mu\text{H}$)

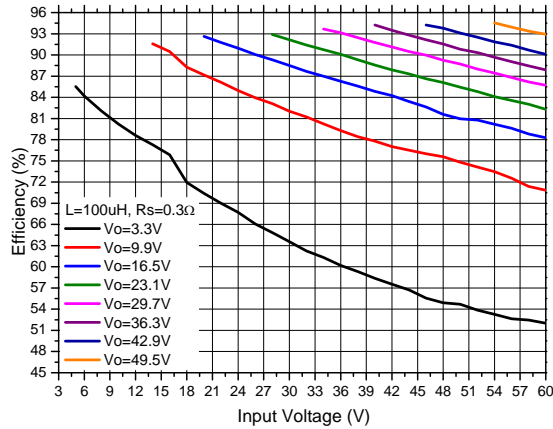

Efficiency vs. Input Voltage
($R_s=0.15\Omega$, $L=68\mu\text{H}$)

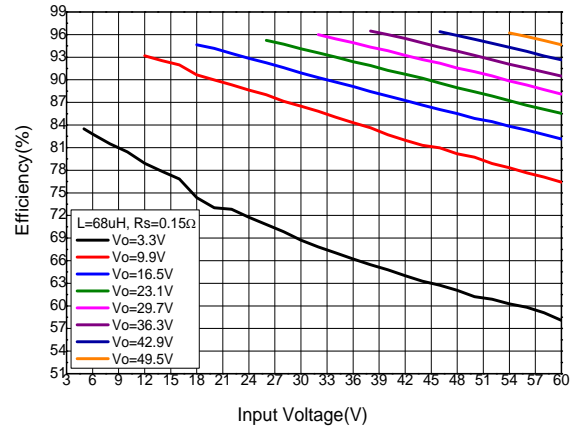

Efficiency vs. Input Voltage
($R_s=0.1\Omega$, $L=100\mu\text{H}$)

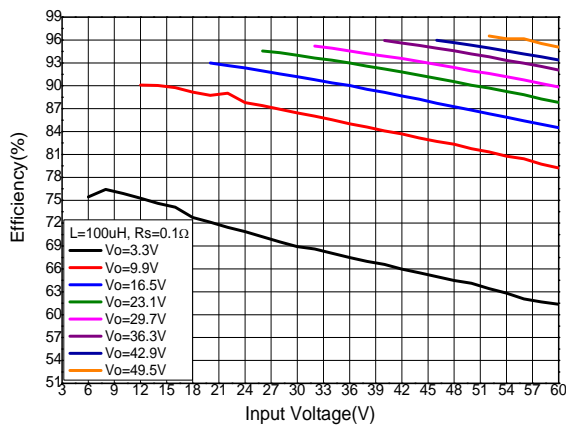

LED Current vs. Input Voltage
($R_s=0.3\Omega$, $L=100\mu\text{H}$)

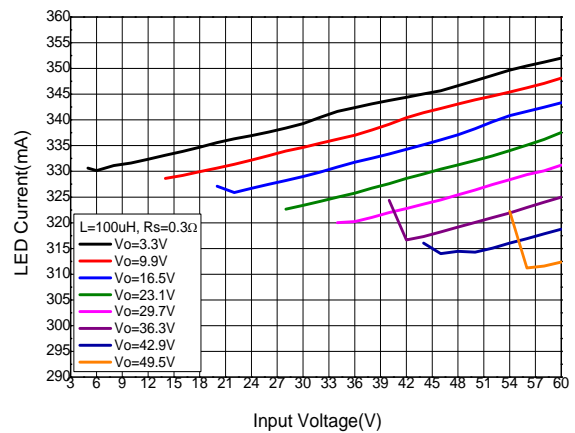

LED Current vs. Input Voltage
($R_s=0.15\Omega$, $L=68\mu\text{H}$)

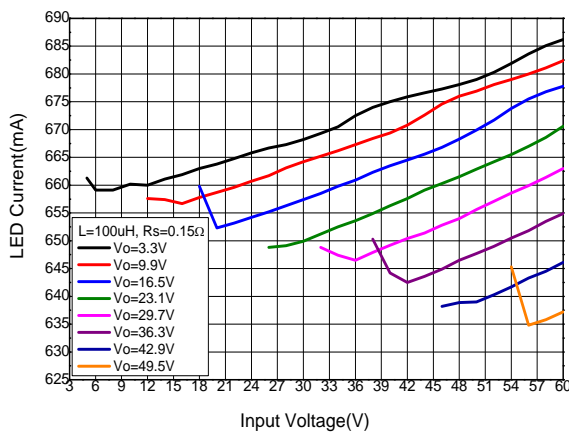

LED Current vs. Input Voltage
($R_s=0.1\Omega$, $L=100\mu\text{H}$)

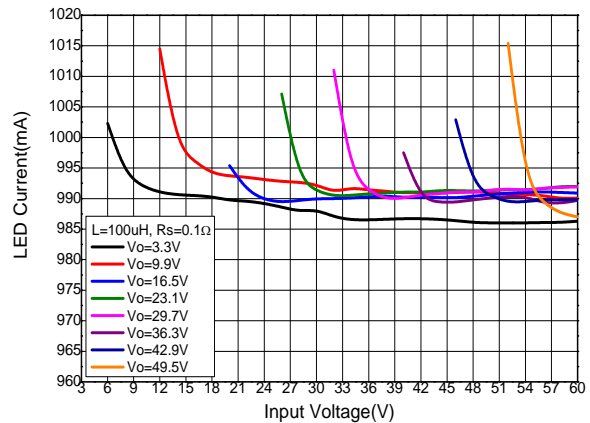

Typical Performance Characteristics (Cont.) ($T_A = +25^\circ\text{C}$, $V_{IN} = 16\text{V}$, unless otherwise noted.)

NEW PRODUCT

Operating Frequency vs. Input Voltage
($R_s=0.3\Omega$, $L=100\mu\text{H}$)

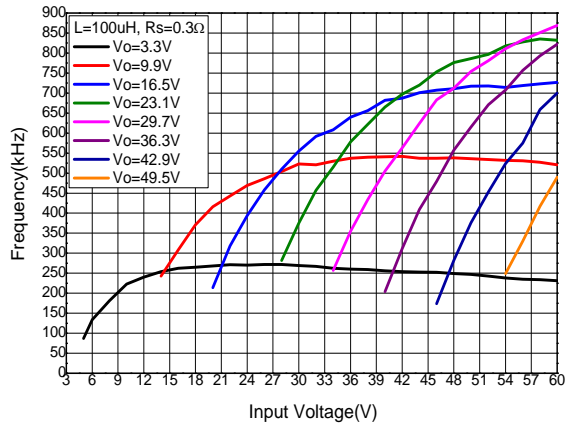

Operating Frequency vs. Input Voltage
($R_s=0.15\Omega$, $L=68\mu\text{H}$)

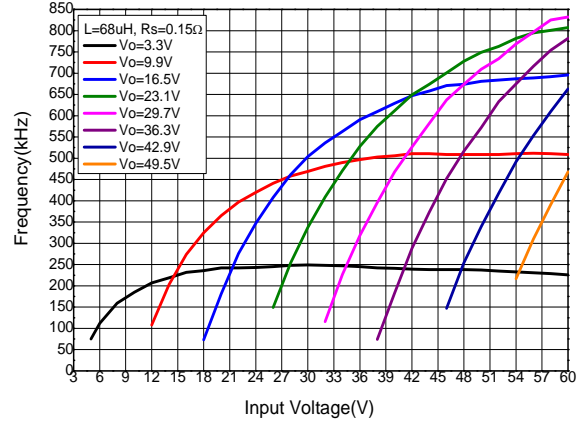

Operating Frequency vs. Input Voltage
($R_s=0.1\Omega$, $L=100\mu\text{H}$)

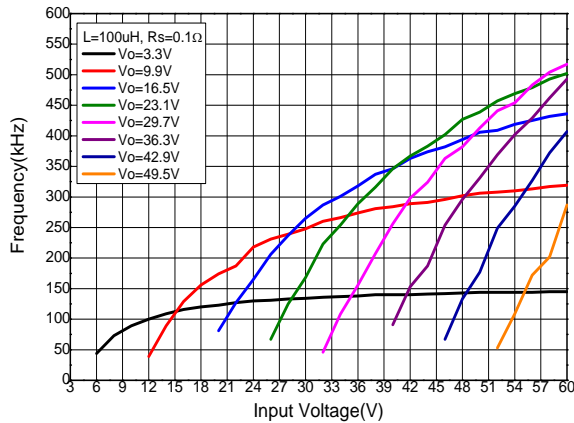

LED Current vs. Output Voltage
($R_s=0.3\Omega$, $L=100\mu\text{H}$)

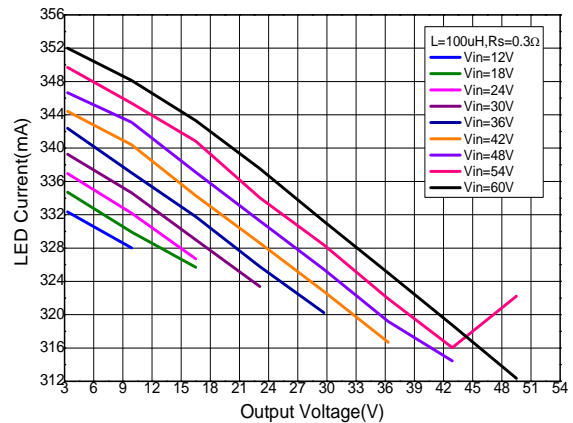

LED Current vs. Output Voltage
($R_s=0.15\Omega$, $L=68\mu\text{H}$)

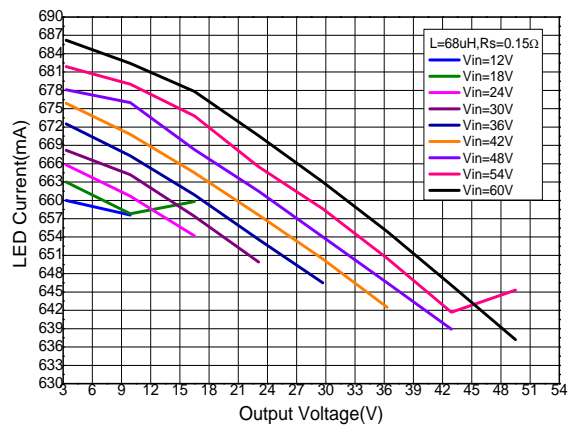

LED Current vs. Output Voltage
($R_s=0.1\Omega$, $L=100\mu\text{H}$)

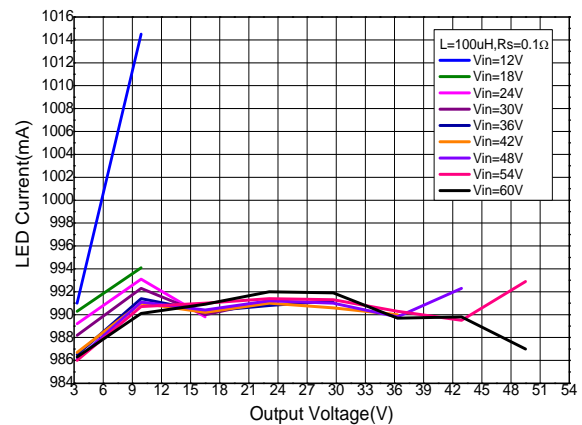

Application Information

AL8862 Operation

In normal operation, when normal input voltage is applied at VIN, the AL8862 internal switch will turn on. Current starts to flow through sense resistor R_{SET}, inductor L1, and the LEDs. The current ramps up linearly, and the ramp-up rate is determined by the input voltage VIN, VOUT and the inductor L1.

This rising current produces a voltage ramp across R_{SET}. The internal circuit of the AL8862 senses the voltage across R_{SET} and applies a proportional voltage to the input of the internal comparator. When this voltage reaches an internally set upper threshold, the internal switch is turned off. The inductor current continues to flow through R_{SET}, L1, LEDs and diode D1, and back to the supply rail, but it decays, with the rate determined by the forward voltage drop of LEDs and the diode D1.

This decaying current produces a falling voltage on R_{SET}, which is sensed by the AL8862. A voltage proportional to the sense voltage across R_{SET} will be applied at the input of internal comparator. When this voltage falls to the internally set lower threshold, the internal switch is turned on again.

This switch-on-and-off cycle continues to provide the average LED current set by the sense resistor R_{SET}.

LED Current Configuration

The nominal average output current in the LED(s) is determined by the value of the external current sense resistor (R_{SET}) connected between VIN and SET and is given by:

$$I_{OUT(NOM)} = \frac{0.1}{R_{SET}}$$

The table below gives values of nominal average output current for several preferred values of current setting resistor (R_{SET}) in the typical application circuit shown on page 1.

R _{SET} (Ω)	Nominal Average Output Current (mA)
0.1	1000
0.15	667
0.3	333

The above values assume that the CTRL pin is floating and at a nominal reference voltage for internal comparator. It is possible to use different values of R_{SET} if the CTRL pin is driven by an external dimming signal.

Analog Dimming

Apply a DC voltage from 0.4V to 2.5V on CTRL pin can adjust output current from 10% to 100% of I_{OUT_NOM} linearly, as shown in Figure 1. If the CTRL pin is brought higher than 2.5V, the LED current will be clamped to 100% of I_{OUT_NOM} while if the CTRL voltage falls below 0.3V, the output switch will turn off.

PWM Dimming

LED current can be adjusted digitally, by applying a low frequency pulse-width-modulated (PWM) logic signal to the CTRL pin to turn the device on and off. This will produce an average output current proportional to the duty cycle of the control signal. To achieve a high resolution the PWM frequency is recommended to be lower than 500Hz, however higher dimming frequencies can be used, at the expense of dimming dynamic range and accuracy. Typically, for a PWM frequency of 500Hz the accuracy is better than 1% for PWM ranging from 1% to 100%.

The accuracy of the low duty cycle dimming is affected by both the PWM frequency and also the switching frequency of the AL8862. For best accuracy/resolution the switching frequency should be increased while the PWM frequency should be reduced.

The CTRL pin is designed to be driven by both 3.3V and 5V logic levels directly from a logic output with either an open drain output or push pull output stage.

Application Information (Cont.)

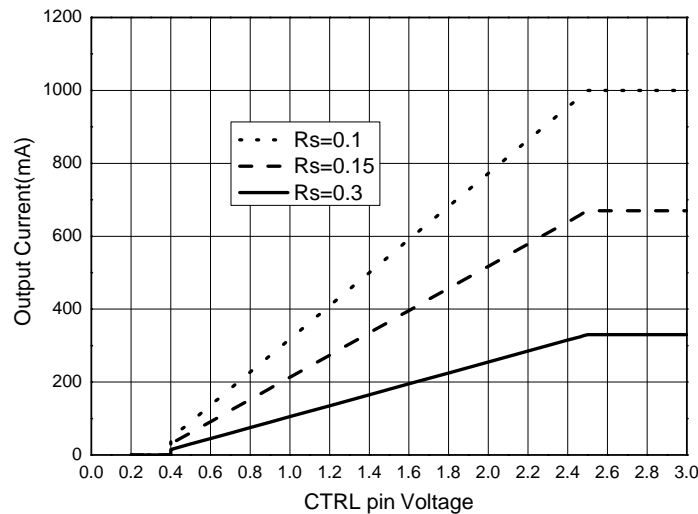

Figure 1. Analog Dimming Curve

Soft Start

The default soft start time for the AL8862 is 0.1ms – this provides very fast turn on of the output, improving PWM dimming accuracy.

Nevertheless, adding an external capacitor from the CTRL pin to ground will provide a longer soft-start delay. This is achieved by increasing the time for the CTRL voltage rising to the turn-on threshold and by slowing down the rising rate of the control voltage at the input of hysteresis comparator. The additional soft start time is related to the capacitance between CTRL and GND, the typical value will be 1.5ms/nF.

Capacitor Selection

A low ESR capacitor should be used for input decoupling, as the ESR of this capacitor appears in series with the supply source impedance and will lower overall efficiency. This capacitor has to supply the relatively high peak current to the coil and smooth the ripple on the input current.

The minimum capacitance needed is determined by input power, cable's length and peak current. 4.7~10µF is a common used value for most of cases. A higher value will improve performance at lower input voltages, especially when the source impedance is high. The input capacitor should be placed as close as possible to the IC.

For maximum stability over temperature and voltage, capacitors with X7R, X5R, or better dielectric are recommended. Capacitors with Y5V dielectric are not suitable for decoupling in this application and should NOT be used.

Diode Selection

For maximum efficiency and performance, the freewheeling diode (D1) should be a fast low capacitance Schottky diode with low reverse leakage current. It also provides better efficiency than silicon diodes, due to lower forward voltage and reduced recovery time.

It is important to select parts with a peak current rating above the peak coil current and a continuous current rating higher than the maximum output load current. It is very important to consider the reverse leakage current of the diode when operating above +85°C. Excess leakage current will increase power dissipation.

The higher forward voltage and overshoot due to reverse recovery time in silicon diodes will increase the peak voltage on the SW output. If a silicon diode is used, more care should be taken to ensure that the total voltage appearing on the SW pin including supply ripple, won't exceed the specified maximum value.

Application Information (Cont.)

Inductor Selection

Recommended inductor value for the AL8862 are in the range 33μH to 100μH. Higher inductance are recommended at higher supply voltages in order to minimize output current tolerance due to switching delays, which will result in increased ripple and lower efficiency. Higher inductance also results in a better line regulation. The inductor should be mounted as close to the device as possible with low resistance connections to SW pins.

The chosen coil should have saturation current higher than the peak output current and a continuous current rating above the required mean output current.

The inductor value should be chosen to maintain operating duty cycle and switch 'on'/'off' times within the specified limits over the supply voltage and load current range. The following equations can be used as a guide.

SW Switch 'On' time

$$t_{ON} = \frac{L\Delta I}{V_{IN} - V_{LED} - I_{LED}(R_{SET} + R_L + R_{SW})}$$

SW Switch 'Off' time

$$t_{OFF} = \frac{L\Delta I}{V_{LED} + V_D + I_{LED}(R_{SET} + R_L)}$$

Where: L is the coil inductance; R_L is the coil resistance; R_{SET} is the current sense resistance; I_{LED} is the required LED current; ΔI is the coil peak-peak ripple current (Internally set to 0.26 x I_{LED}); V_{IN} is the supply voltage; V_{LED} is the total LED forward voltage; R_{SW} is the switch resistance (0.55Ω nominal); V_D is the diode forward voltage at the required load current.

Thermal Protection

The AL8862 includes Over-Temperature Protection (OTP) circuitry that will turn off the device if its junction temperature gets too high. This is to protect the device from excessive heat damage. The OTP circuitry includes thermal hysteresis that will cause the device to restart normal operation once its junction temperature has cooled down by approximately +30°C.

Open-Circuit LED Protection

The AL8862 has by default open LED protection. If the LEDs should become open circuit the AL8862 will stop oscillating; the SET pin will rise to V_{IN} and the SW pin will then fall to GND. No excessive voltages will be seen by the AL8862.

LED Short-Circuit Protection

If the LED string should become shorted together (the anode of the top LED becomes shorted to the cathode of the bottom LED) the AL8862 will continue to switch and the current through the AL8862's internal switch will still be at the expected current - so no excessive heat will be generated within the AL8862. However, the duty cycle at which it operates will change dramatically and the switching frequency will most likely decrease. See Figure 2 for an example of this behavior at 24V input voltage driving 3 LEDs.

The on-time of the internal power MOSFET switch is significantly reduced because almost all of the input voltage is now developed across the inductor. The off-time is significantly increased because the reverse voltage across the inductor is now just the Schottky diode voltage (See Figure 2) causing a much slower decay in inductor current.

Application Information (Cont.)

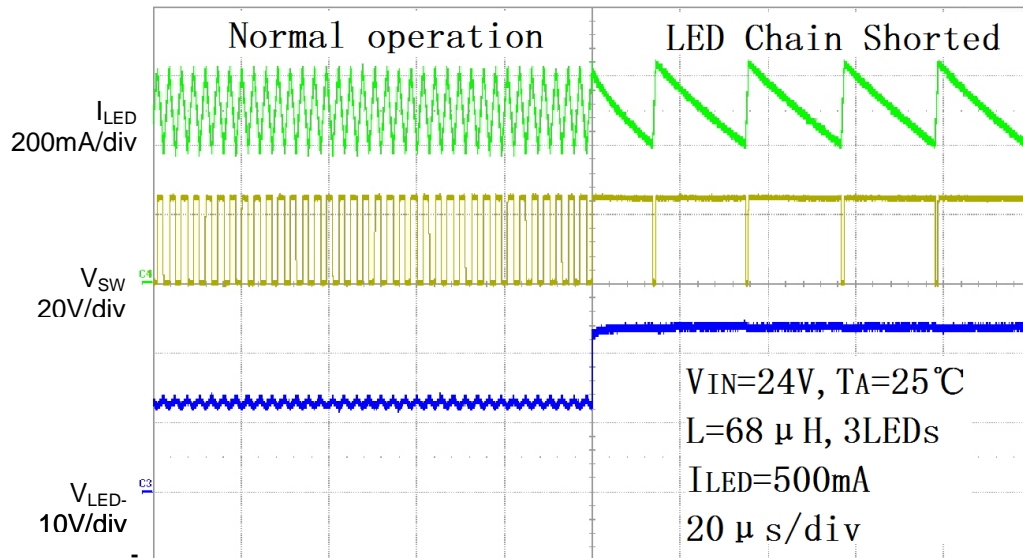

Figure 2. Switching Characteristics (Normal Operation to LED String Shorted)

Current Sense Resistor Short-Circuit Protection

The AL8862 has an internal current limit at about 3A. If current-sense resistor R_{SET} is shorted, current limit is triggered for accumulated 8 times and the switch will shut down and latch up.

NEW PRODUCT

Ordering Information

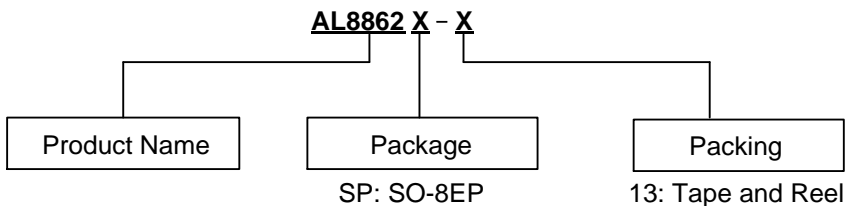

Part Number	Package Code	Package	13" Tape and Reel	
			Quantity	Part Number Suffix
AL8862SP-13	SP	SO-8EP	2500/Tape & Reel	-13

Marking Information

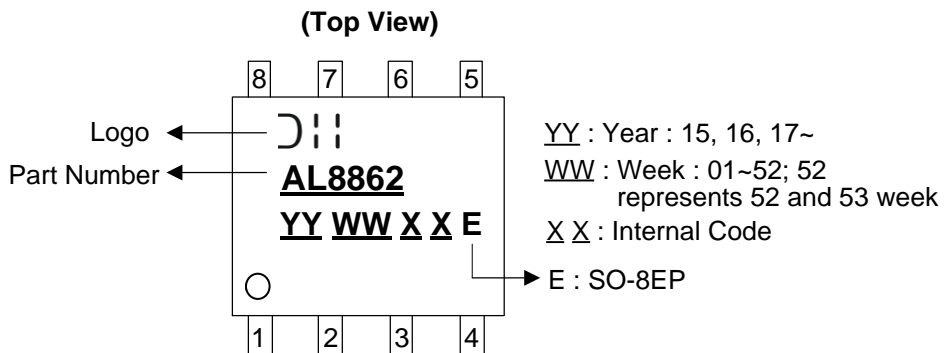

Package Outline Dimensions (All dimensions in mm.)

Package Type: SO-8EP

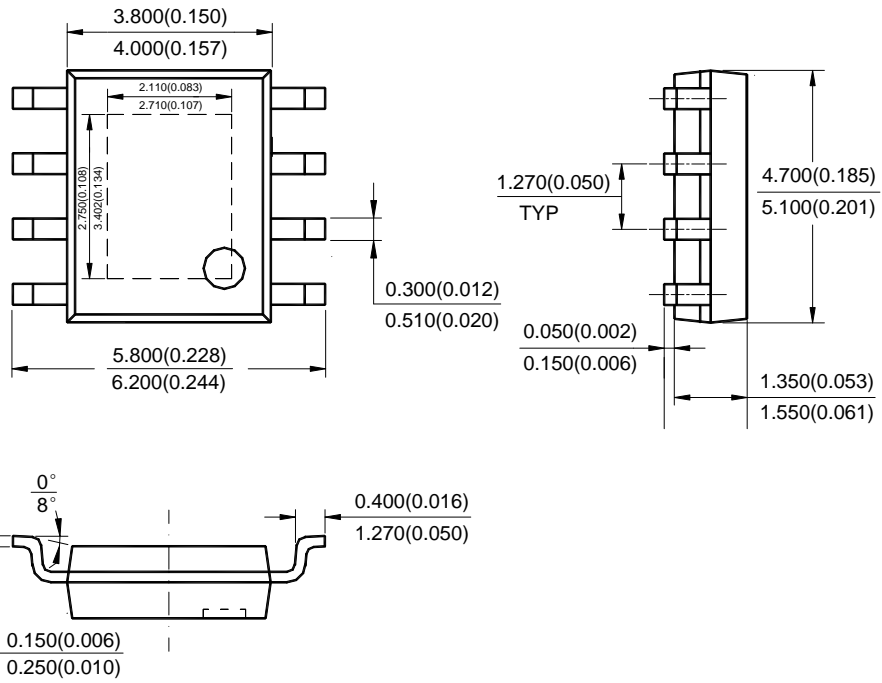

Note: Eject hole, oriented hole and mold mark is optional.

NEW PRODUCT

Suggested Pad Layout

Package Type: SO-8EP

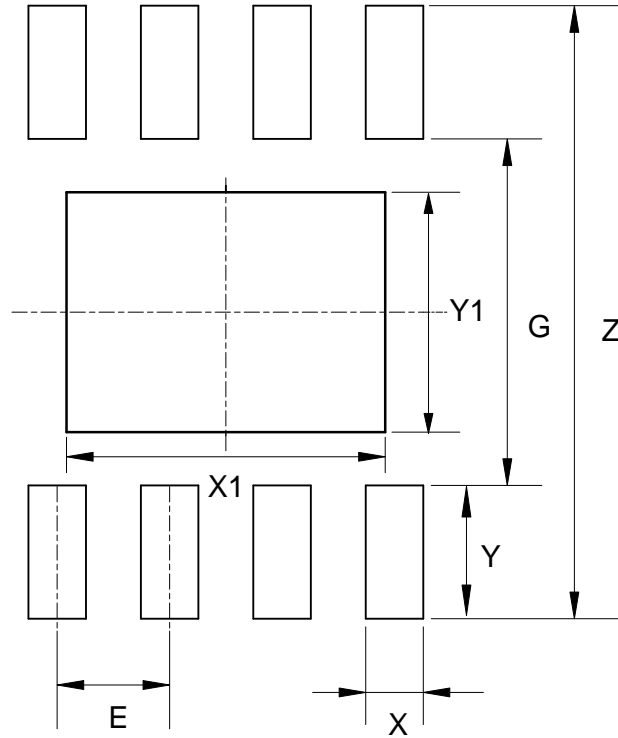

Dimensions	Z (mm)/(inch)	G (mm)/(inch)	X (mm)/(inch)	Y (mm)/(inch)	X1 (mm)/(inch)	Y1 (mm)/(inch)	E (mm)/(inch)
Value	6.900/0.272	3.900/0.154	0.650/0.026	1.500/0.059	3.600/0.142	2.700/0.106	1.270/0.050

NEW PRODUCT

IMPORTANT NOTICE

DIODES INCORPORATED MAKES NO WARRANTY OF ANY KIND, EXPRESS OR IMPLIED, WITH REGARDS TO THIS DOCUMENT, INCLUDING, BUT NOT LIMITED TO, THE IMPLIED WARRANTIES OF MERCHANTABILITY AND FITNESS FOR A PARTICULAR PURPOSE (AND THEIR EQUIVALENTS UNDER THE LAWS OF ANY JURISDICTION).

Diodes Incorporated and its subsidiaries reserve the right to make modifications, enhancements, improvements, corrections or other changes without further notice to this document and any product described herein. Diodes Incorporated does not assume any liability arising out of the application or use of this document or any product described herein; neither does Diodes Incorporated convey any license under its patent or trademark rights, nor the rights of others. Any Customer or user of this document or products described herein in such applications shall assume all risks of such use and will agree to hold Diodes Incorporated and all the companies whose products are represented on Diodes Incorporated website, harmless against all damages.

Diodes Incorporated does not warrant or accept any liability whatsoever in respect of any products purchased through unauthorized sales channel. Should Customers purchase or use Diodes Incorporated products for any unintended or unauthorized application, Customers shall indemnify and hold Diodes Incorporated and its representatives harmless against all claims, damages, expenses, and attorney fees arising out of, directly or indirectly, any claim of personal injury or death associated with such unintended or unauthorized application.

Products described herein may be covered by one or more United States, international or foreign patents pending. Product names and markings noted herein may also be covered by one or more United States, international or foreign trademarks.

This document is written in English but may be translated into multiple languages for reference. Only the English version of this document is the final and determinative format released by Diodes Incorporated.

LIFE SUPPORT

Diodes Incorporated products are specifically not authorized for use as critical components in life support devices or systems without the express written approval of the Chief Executive Officer of Diodes Incorporated. As used herein:

A. Life support devices or systems are devices or systems which:

1. are intended to implant into the body, or
2. support or sustain life and whose failure to perform when properly used in accordance with instructions for use provided in the labeling can be reasonably expected to result in significant injury to the user.

B. A critical component is any component in a life support device or system whose failure to perform can be reasonably expected to cause the failure of the life support device or to affect its safety or effectiveness.

Customers represent that they have all necessary expertise in the safety and regulatory ramifications of their life support devices or systems, and acknowledge and agree that they are solely responsible for all legal, regulatory and safety-related requirements concerning their products and any use of Diodes Incorporated products in such safety-critical, life support devices or systems, notwithstanding any devices- or systems-related information or support that may be provided by Diodes Incorporated. Further, Customers must fully indemnify Diodes Incorporated and its representatives against any damages arising out of the use of Diodes Incorporated products in such safety-critical, life support devices or systems.

Copyright © 2017, Diodes Incorporated

www.diodes.com